

# 2023婕斯羽你同行國小暨親子分齡賽

取4名

國小二年級組女單 共24籤

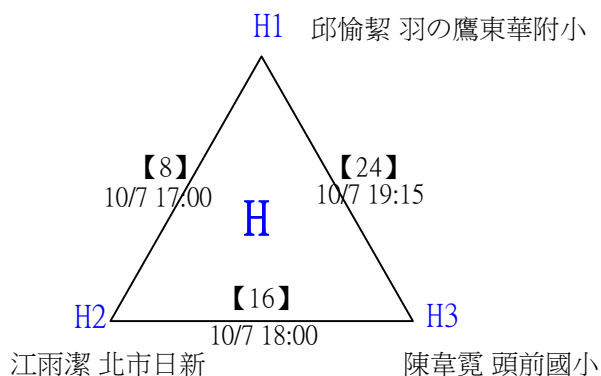
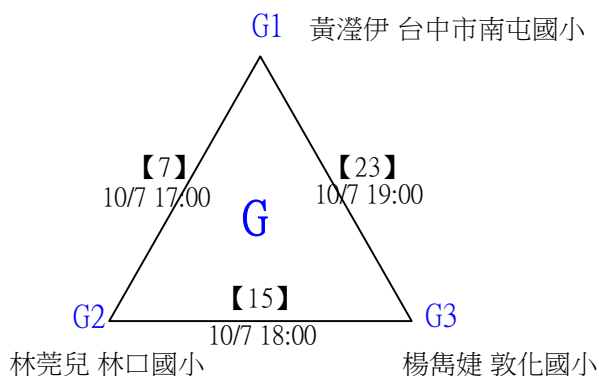
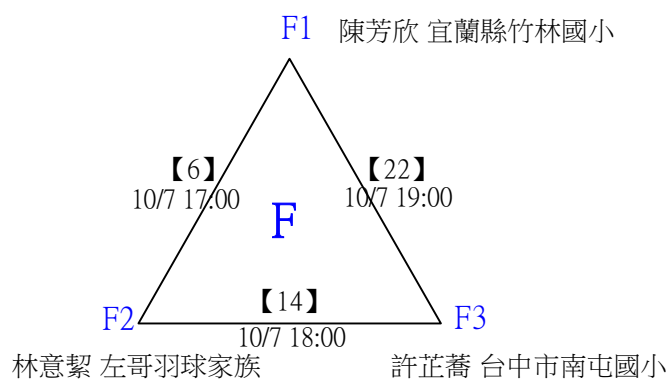
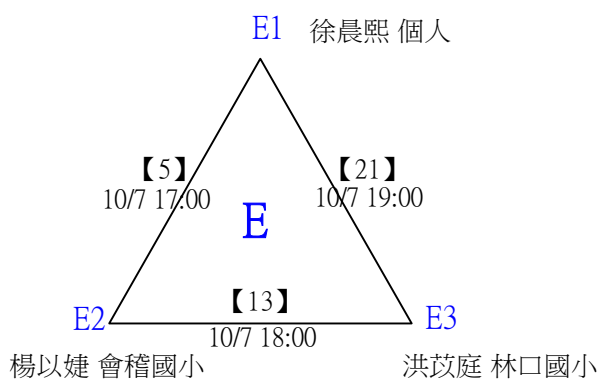
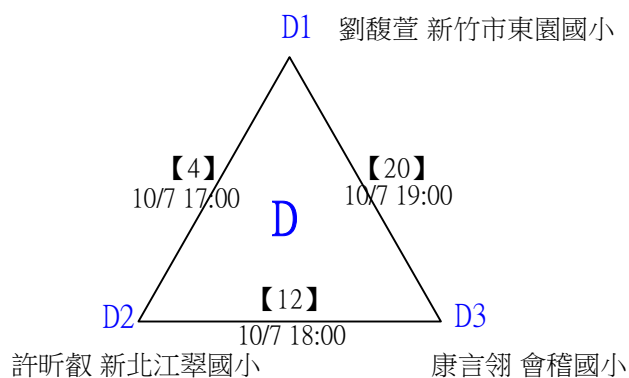
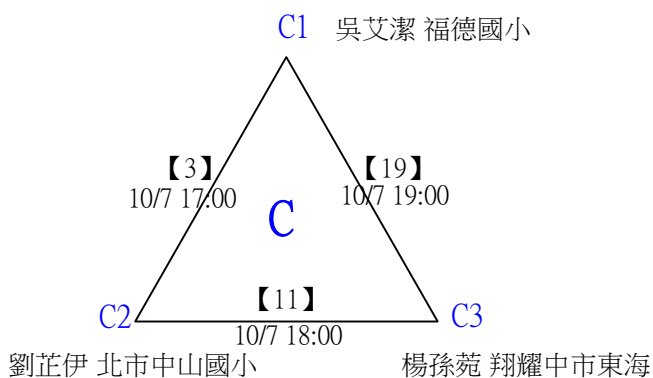
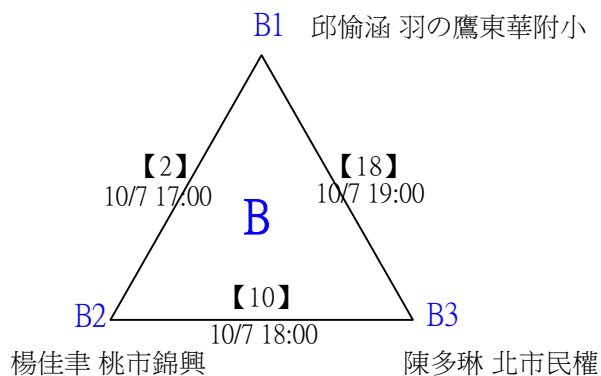
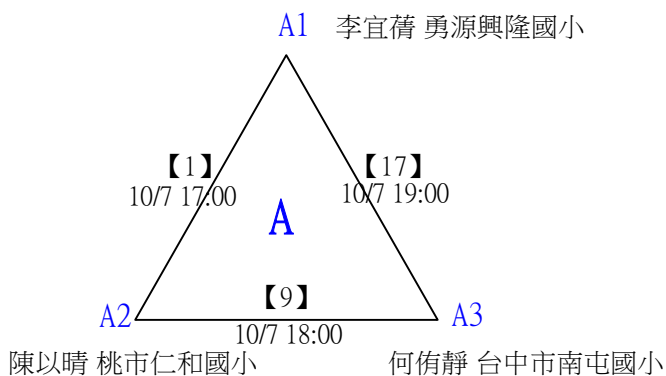

# 2023婕斯羽你同行國小暨親子分齡賽

取4名

國小二年級組女單

決賽：三角取一，抽籤決定位置。

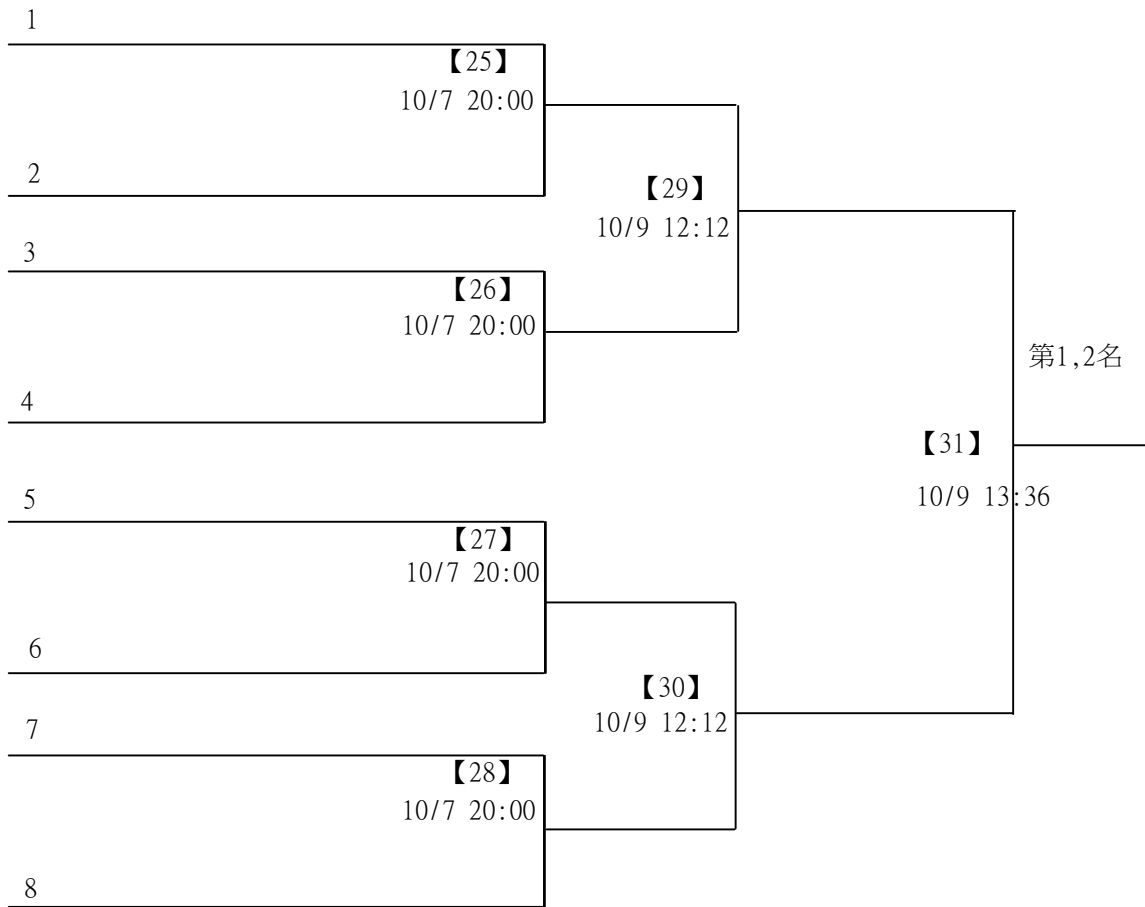

# 2023婕斯羽你同行國小暨親子分齡賽

取8名

國小二年級組男單 共54籤

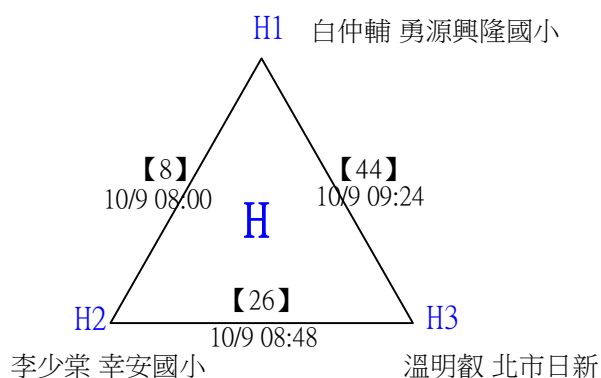
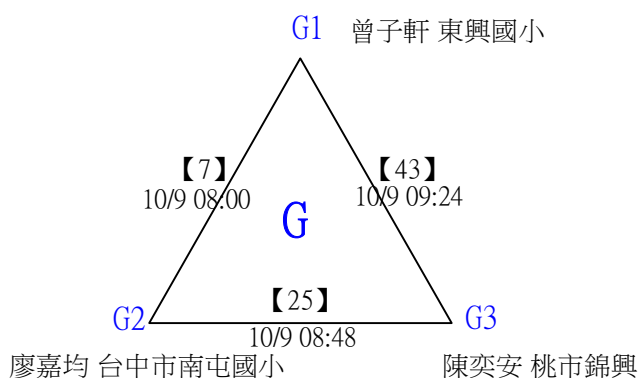
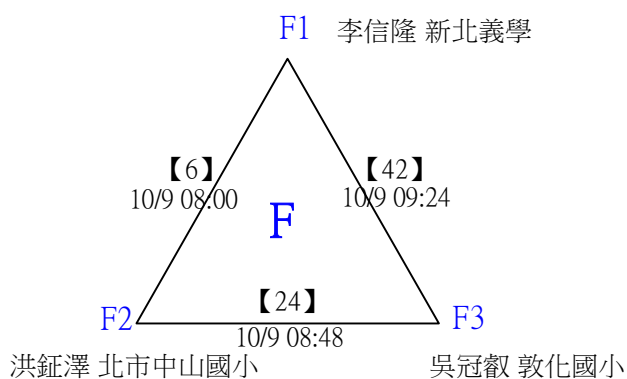
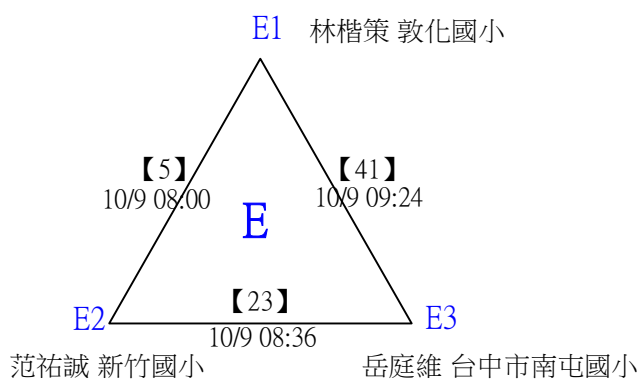
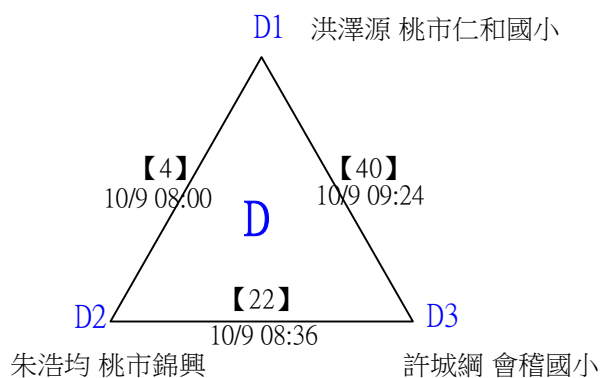
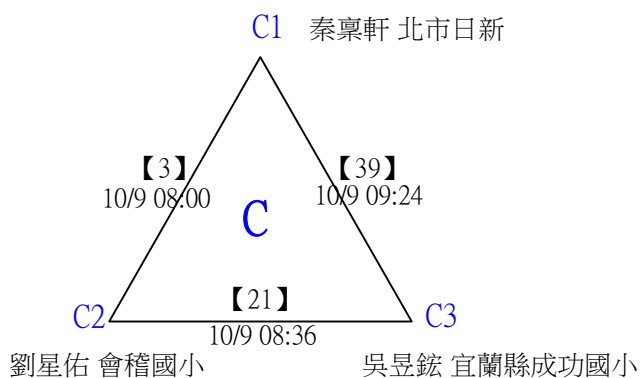
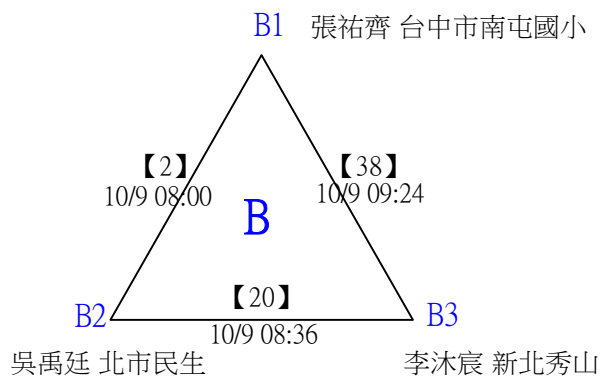
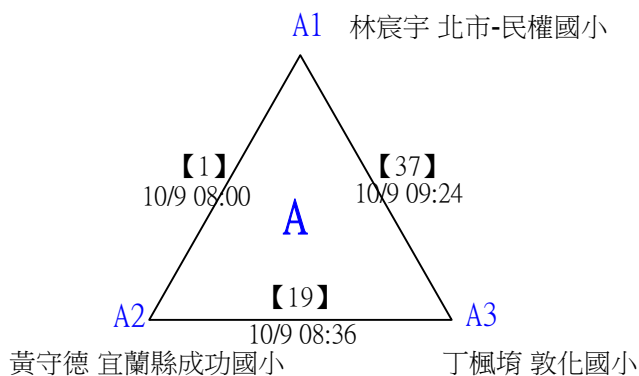

# 2023婕斯羽你同行國小暨親子分齡賽

取8名

國小二年級組男單 共54籤

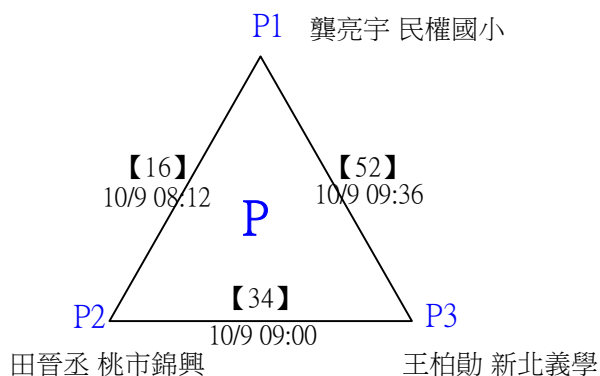
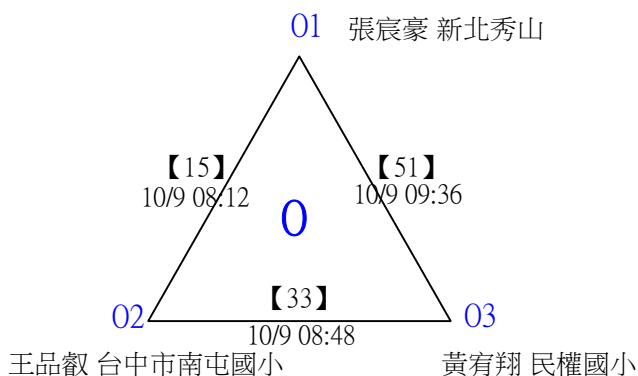
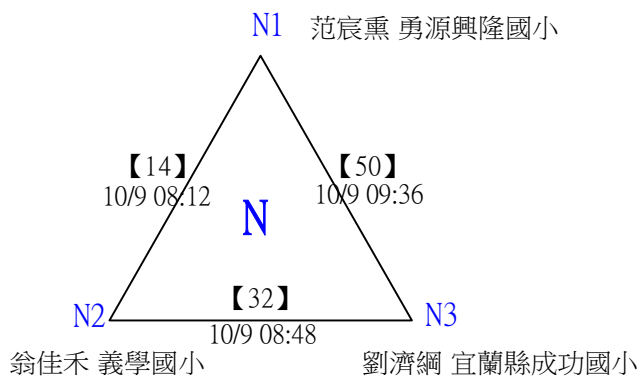
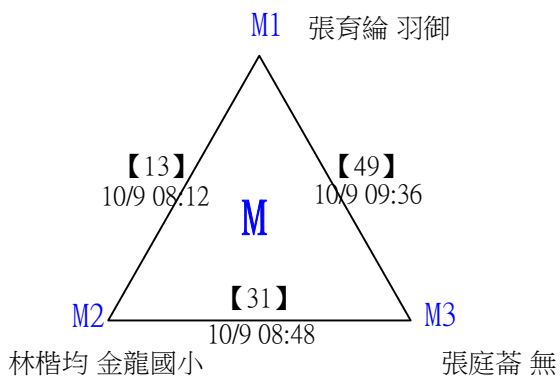
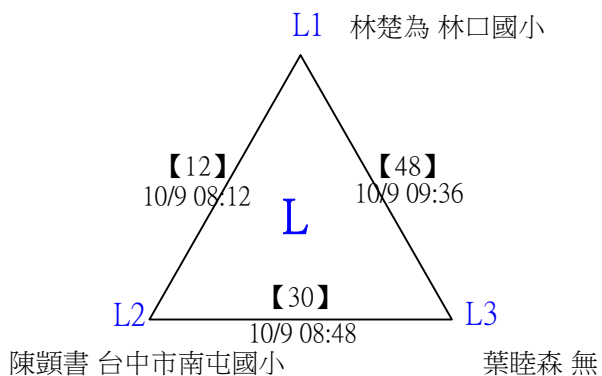
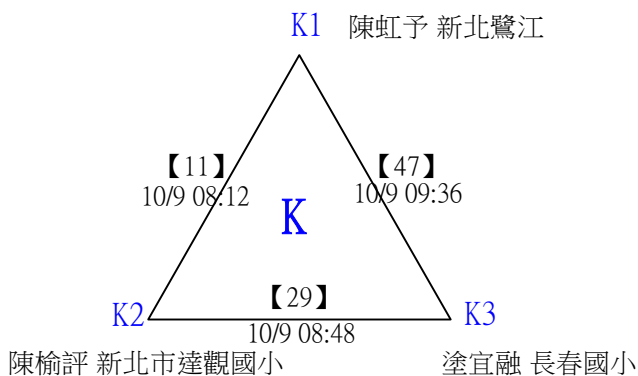
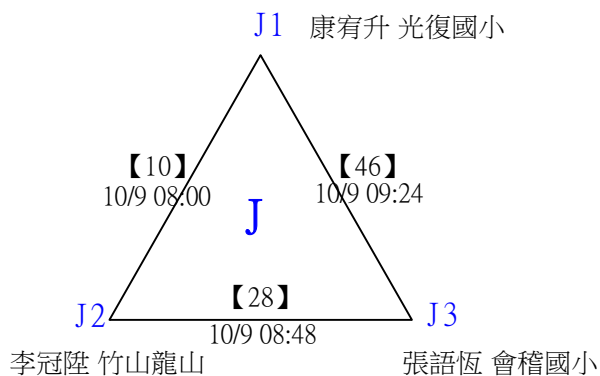
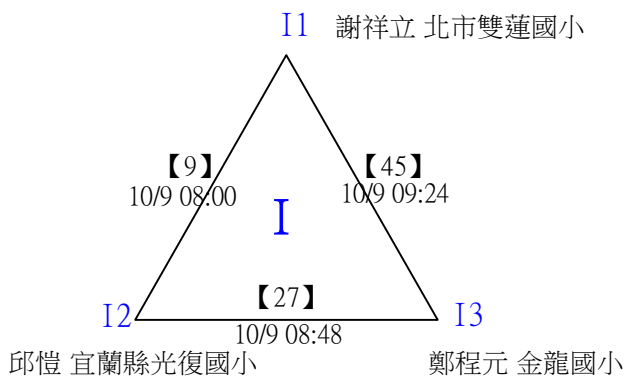

# 2023婕斯羽你同行國小暨親子分齡賽

國小二年級組男單 共54籤

取8名

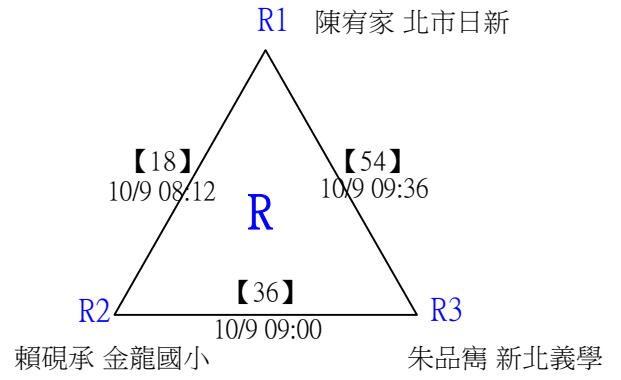
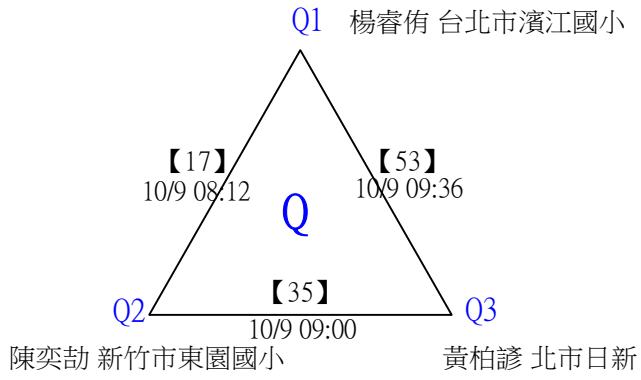

# 2023 婕斯羽你同行 國小暨親子分齡賽

取8名

國小二年級組男單

決賽：三角取一，抽籤決定位置。

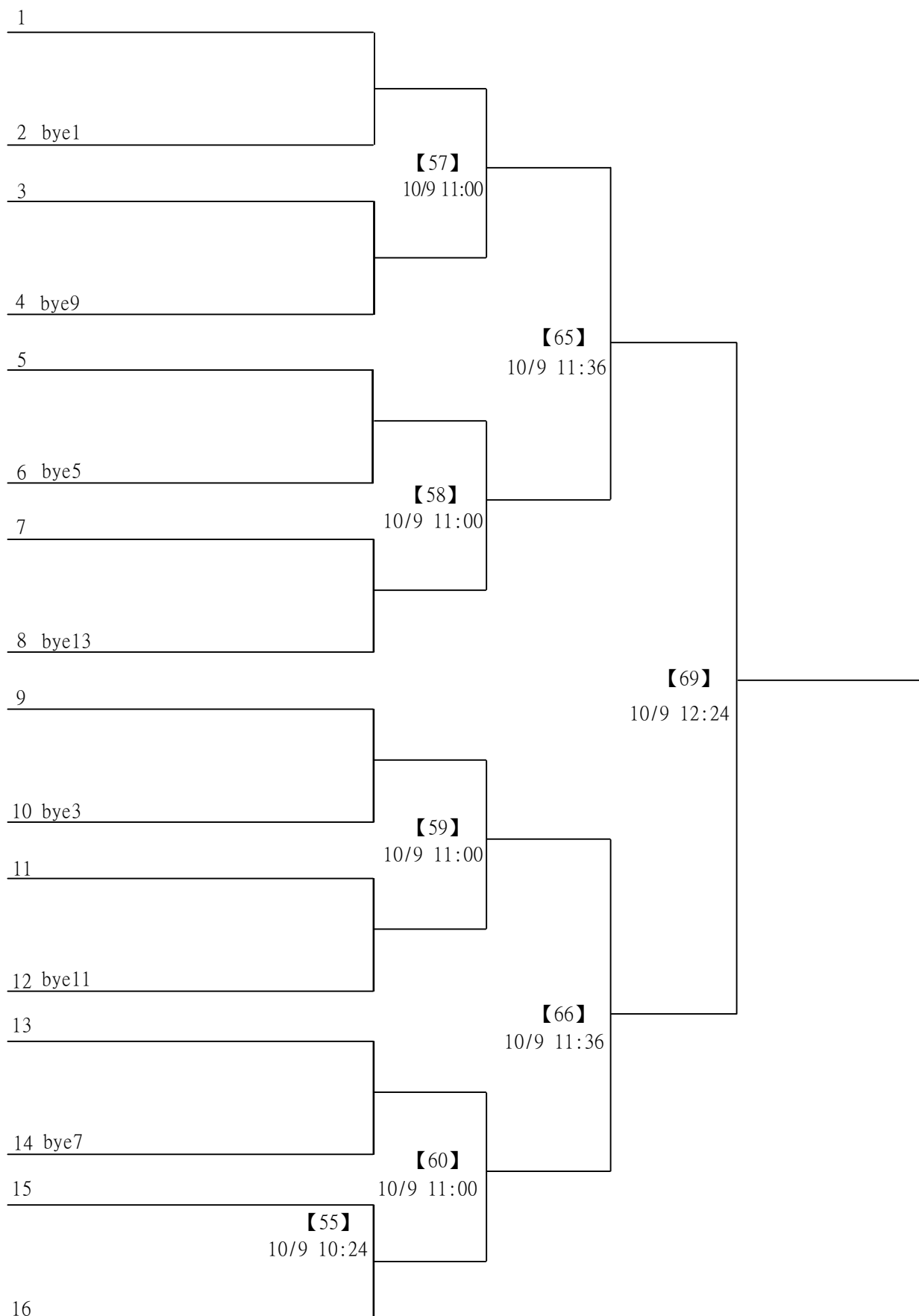

# 2023 婕斯羽你同行 國小暨親子分齡賽

取8名

國小二年級組男單

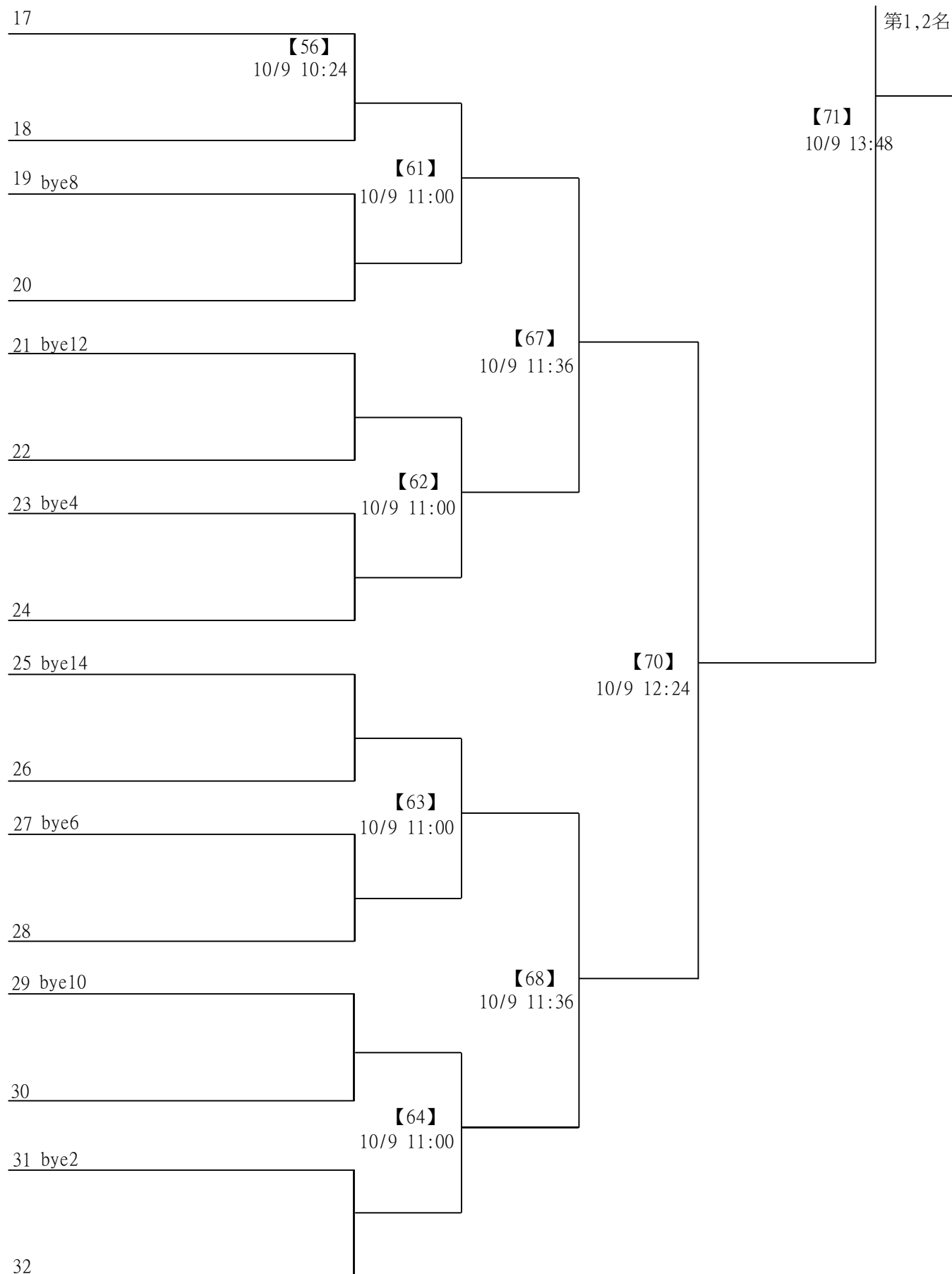

# 2023婕斯羽你同行國小暨親子分齡賽

取4名

國小三年級組女單 共49籤

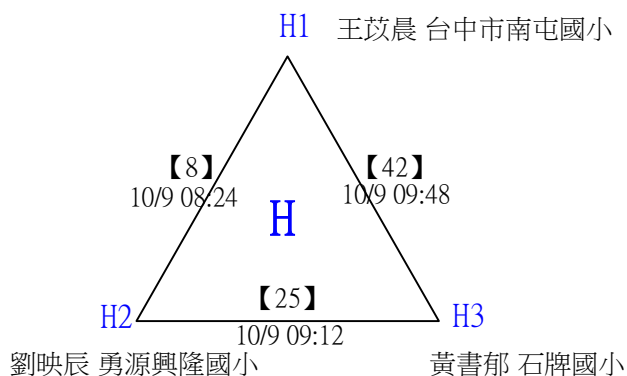
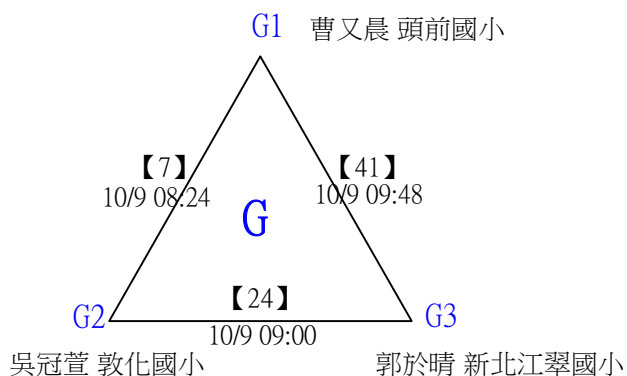
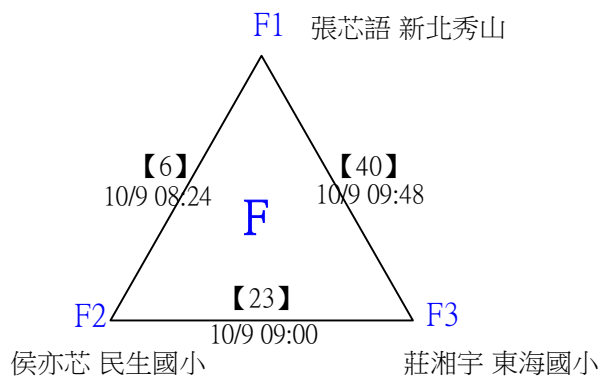
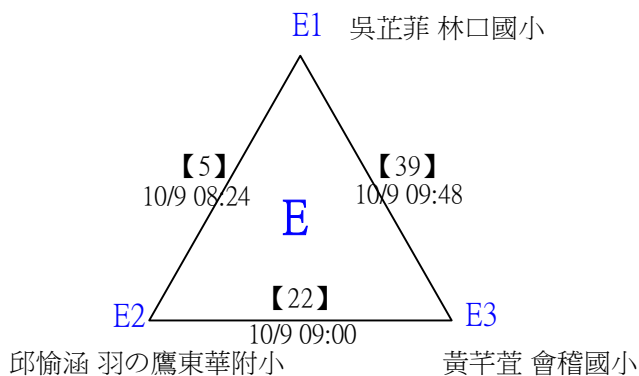
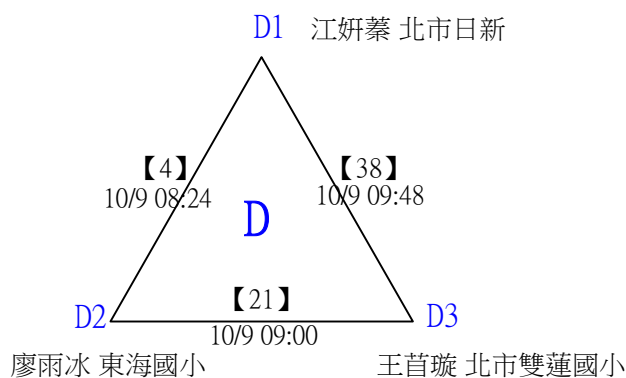
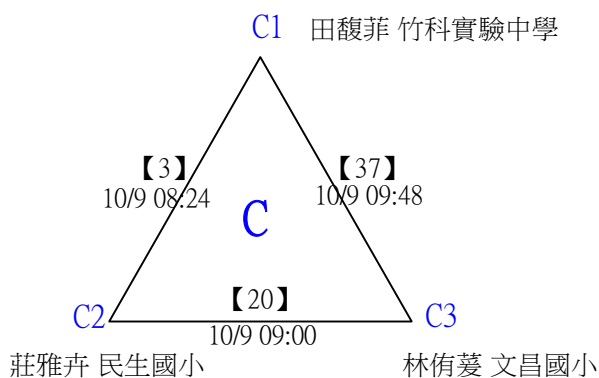
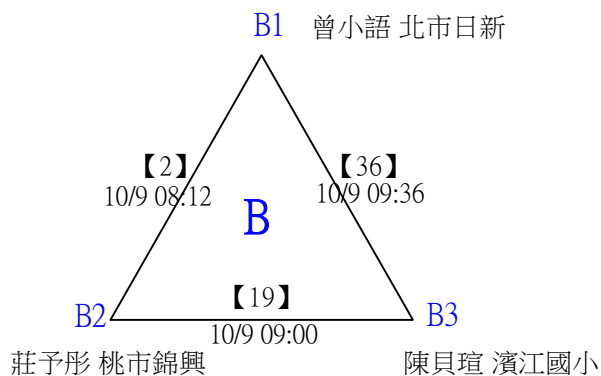
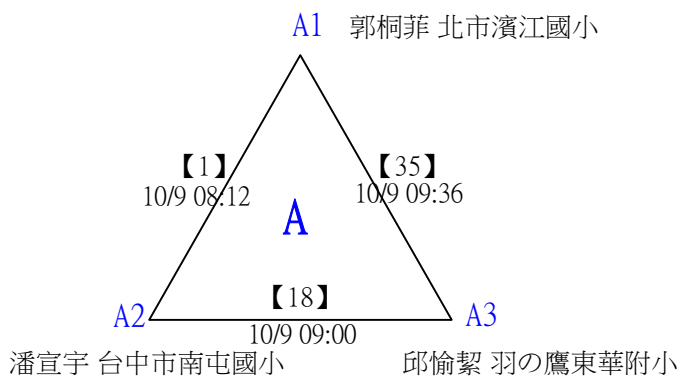



# 2023婕斯羽你同行國小暨親子分齡賽

取4名

國小三年級組女單 共49籤

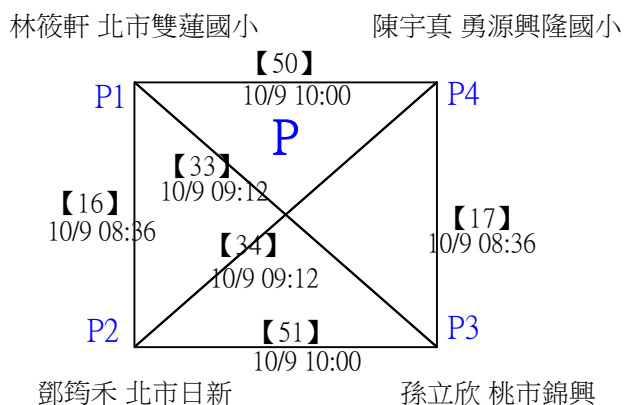
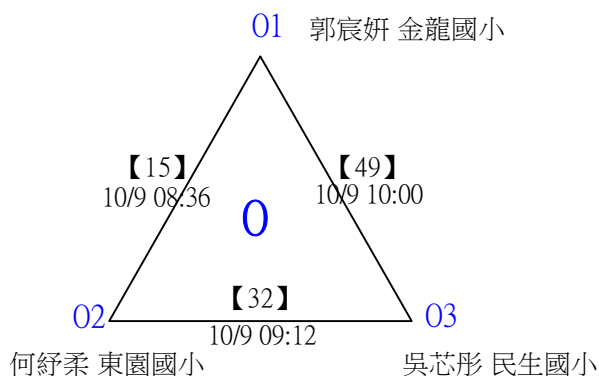
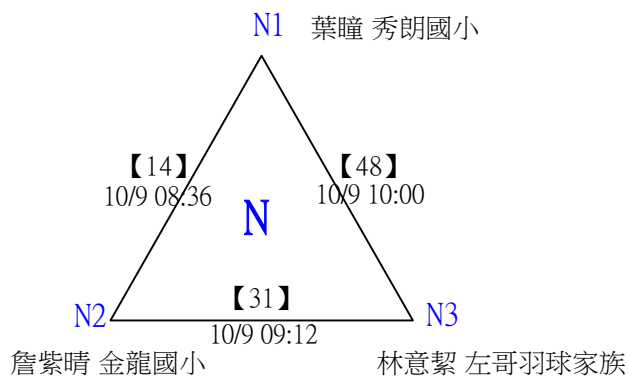
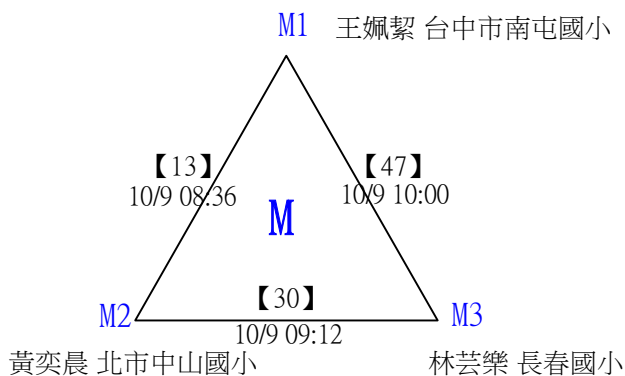
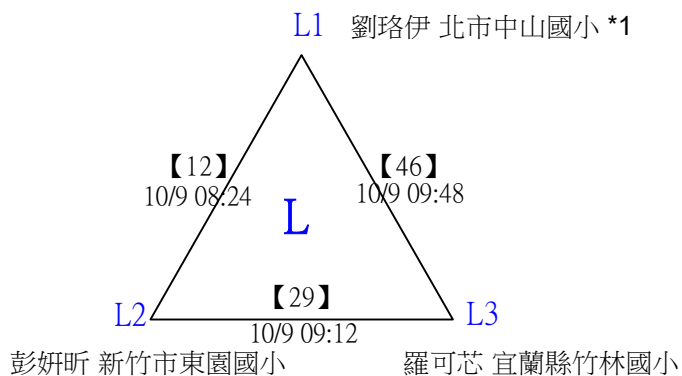
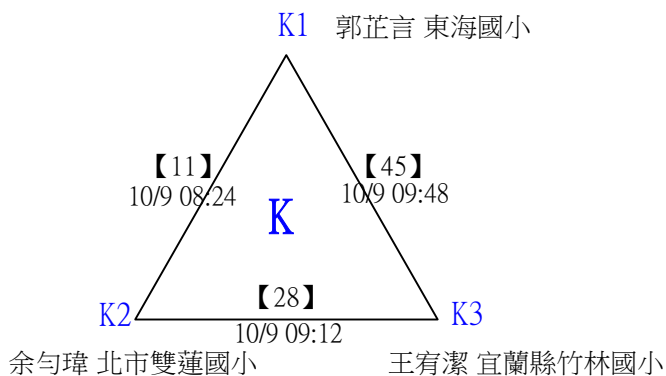
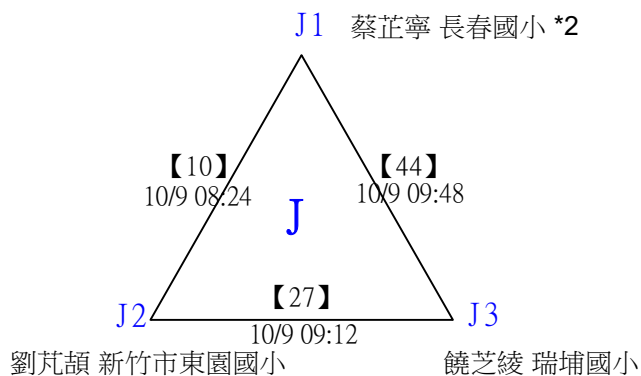
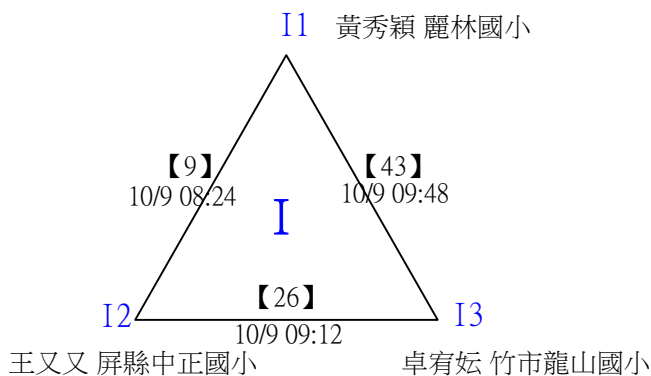

# 2023 婕斯羽你同行 國小暨親子分齡賽

取4名

國小三年級組女單

決賽：三角取一，四角取二，抽籤決定位置。

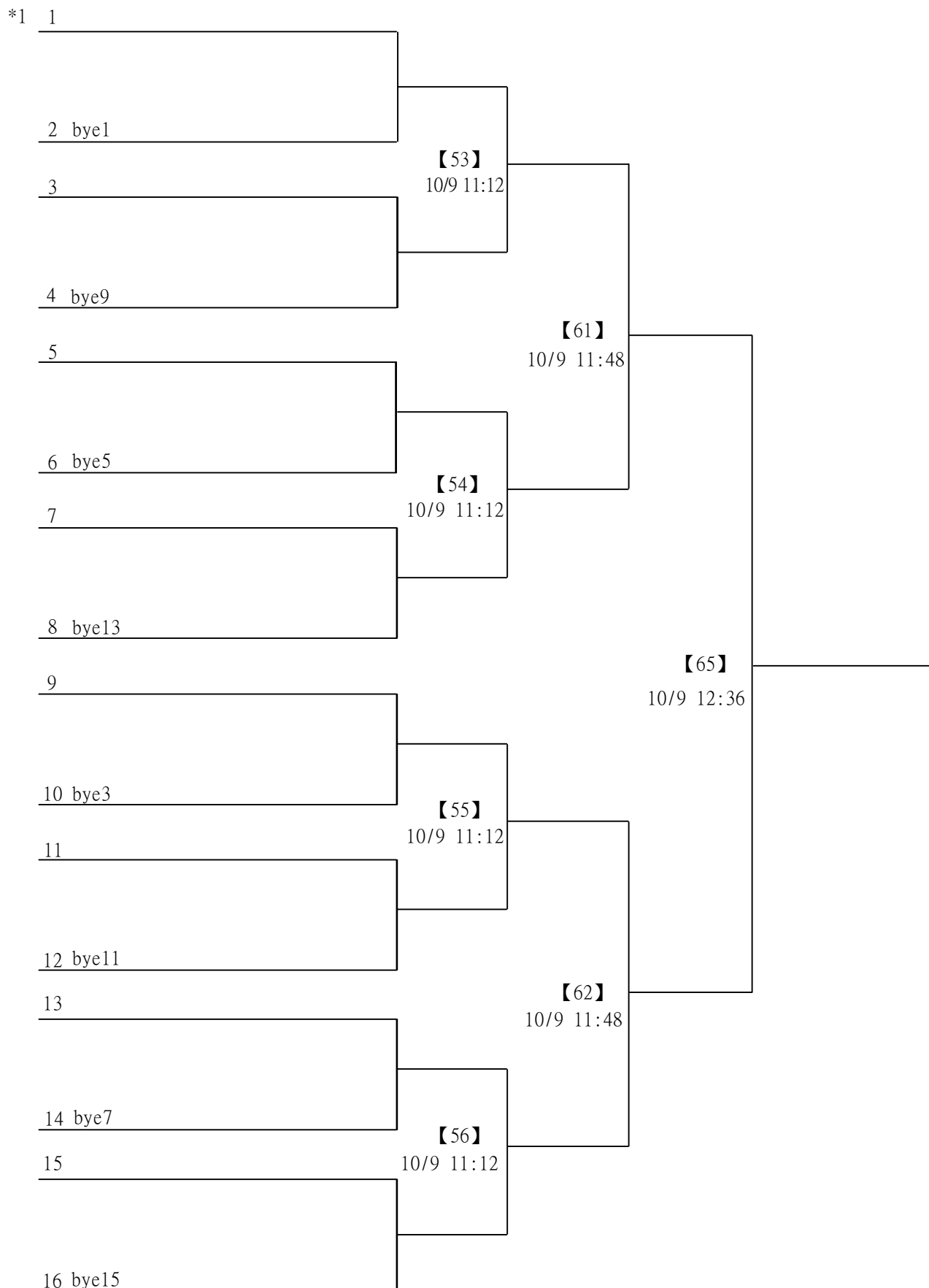

# 2023 婕斯羽你同行 國小暨親子分齡賽

取4名

國小三年級組女單

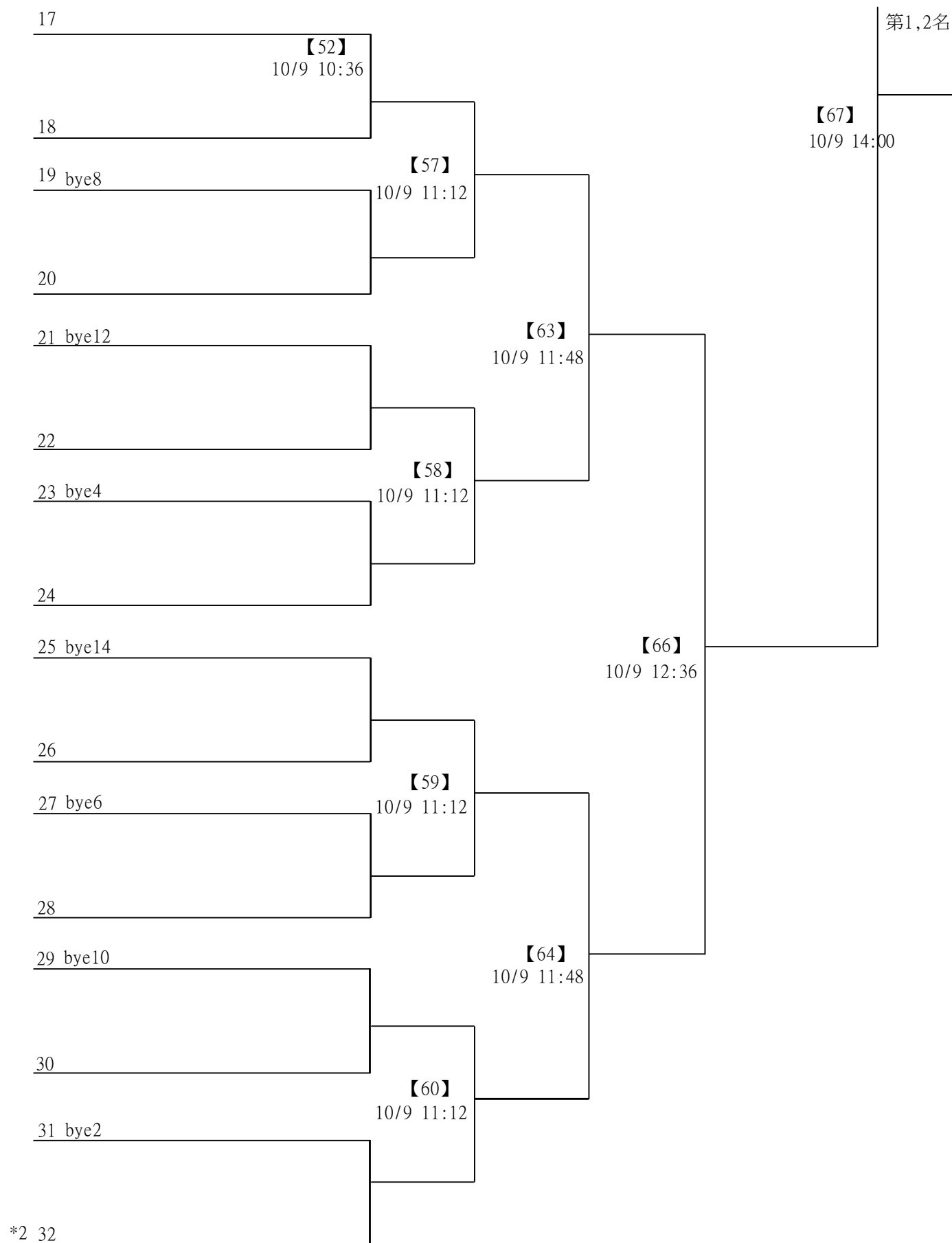

# 2023婕斯羽你同行國小暨親子分齡賽

取16名

國小三年級組男單 共110籤

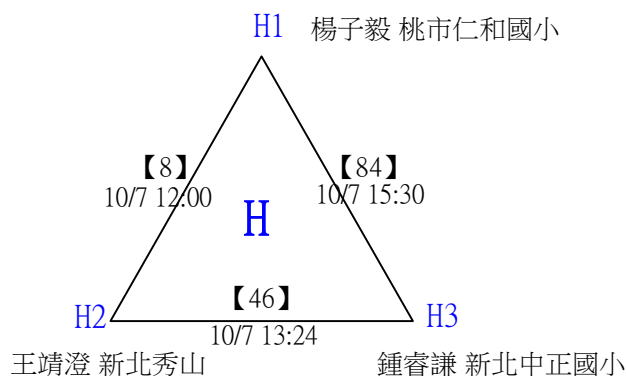
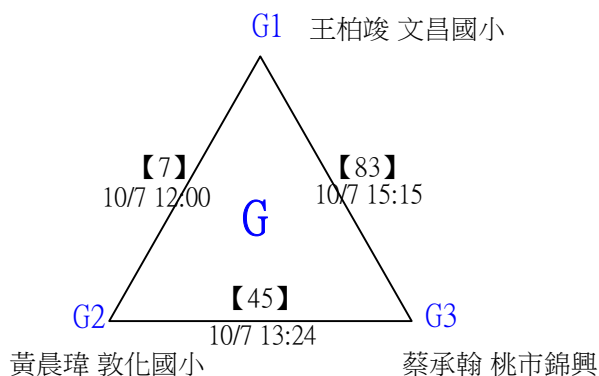
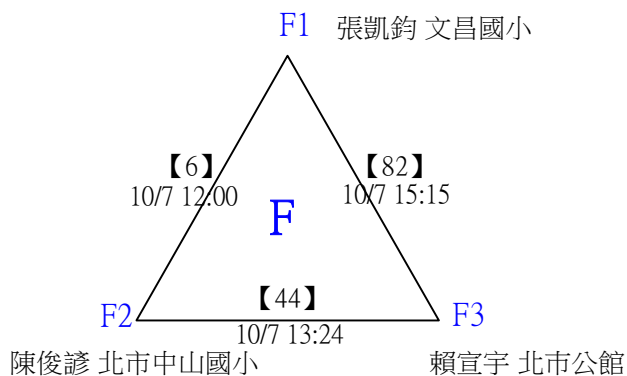
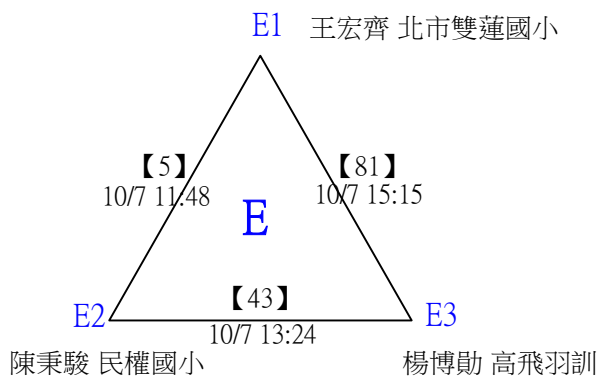
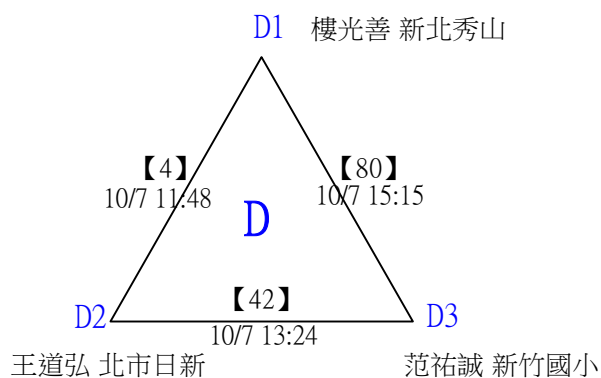
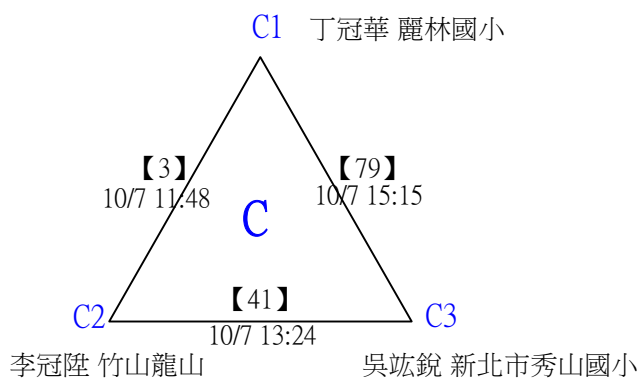
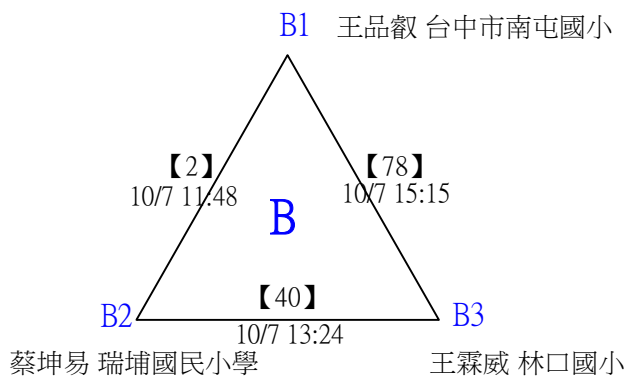
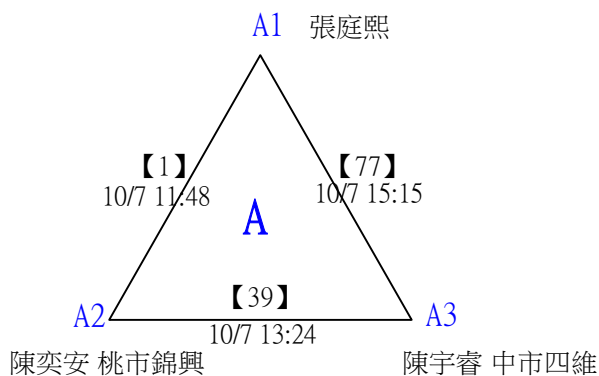

# 2023婕斯羽你同行國小暨親子分齡賽

取16名

國小三年級組男單 共110籤

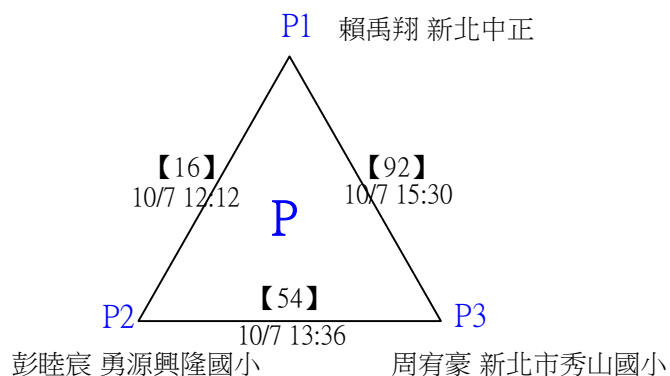
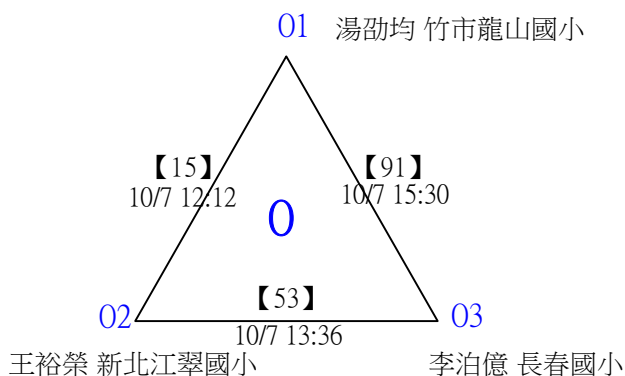
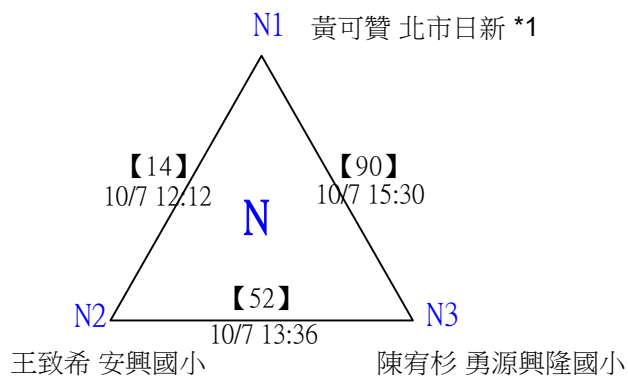
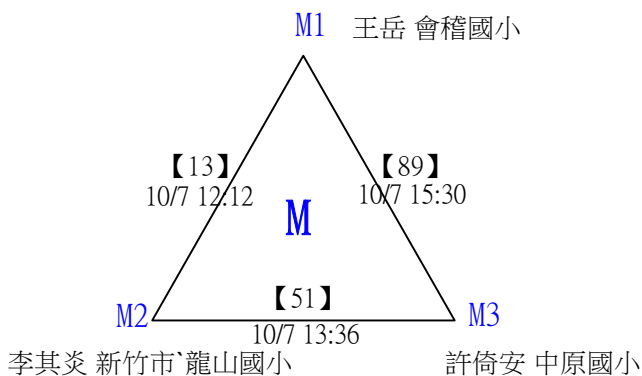
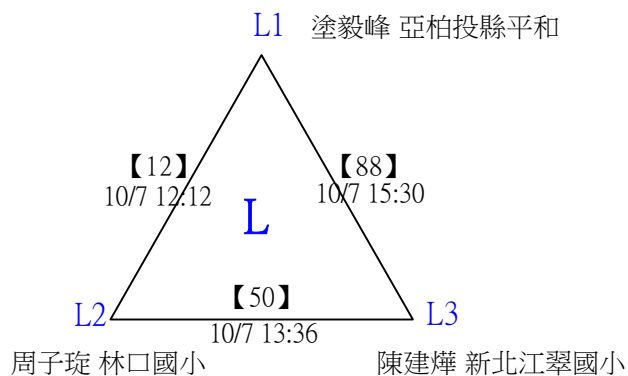
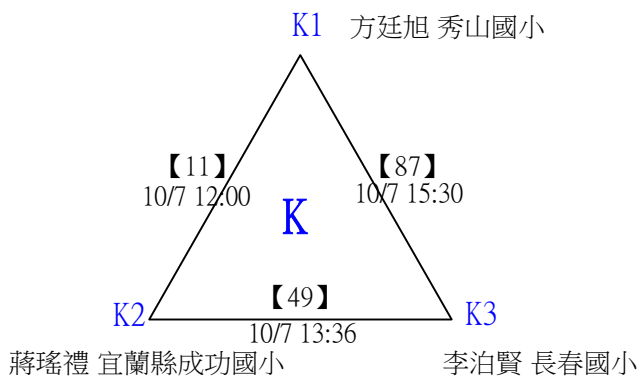
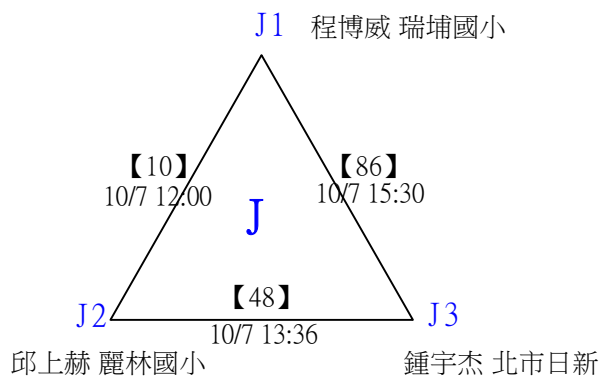
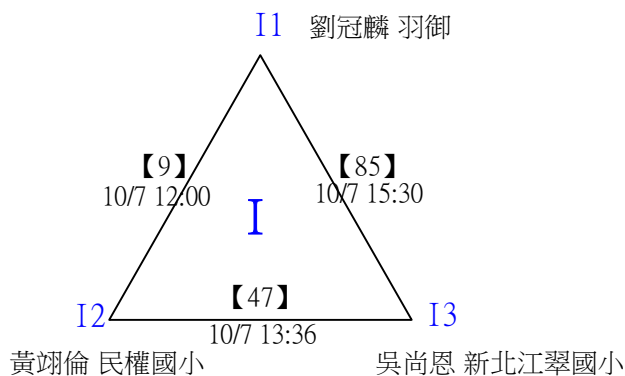

# 2023 婕斯羽你同行 國小暨親子分齡賽

取16名

國小三年級組男單 共110籤

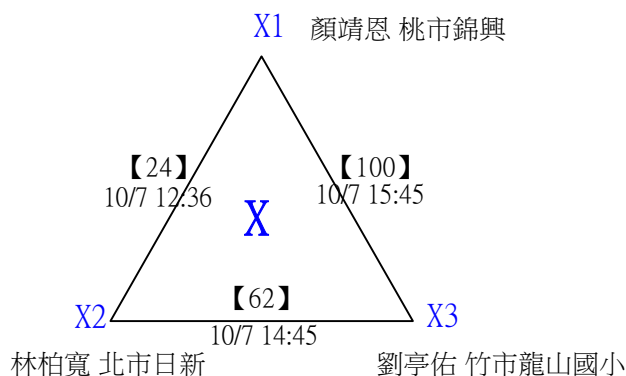
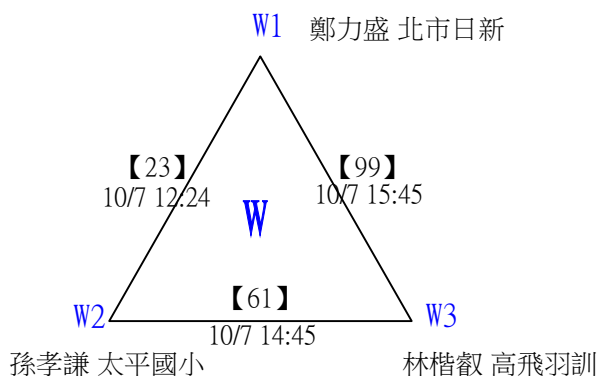
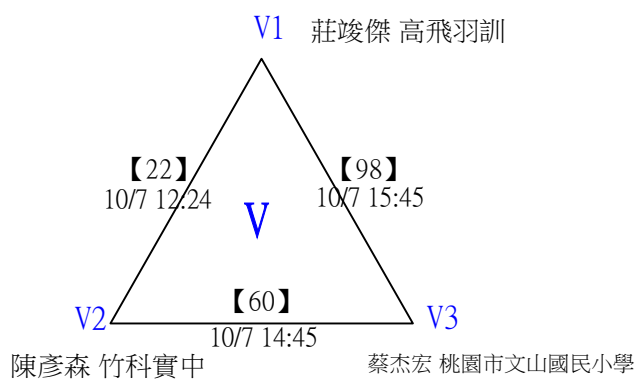
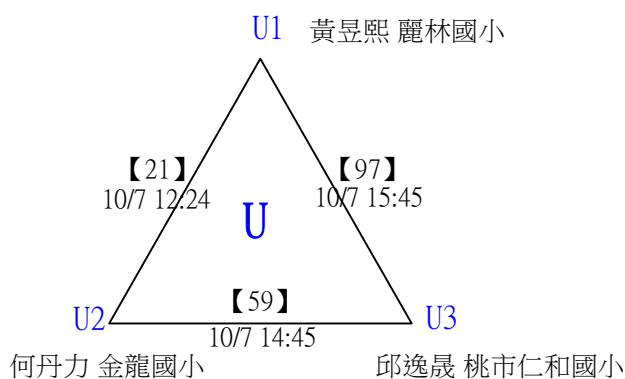
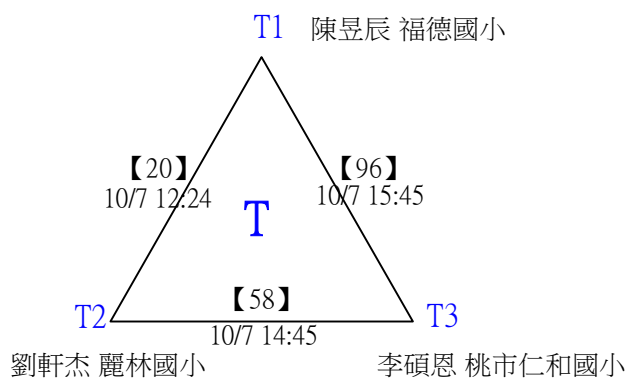
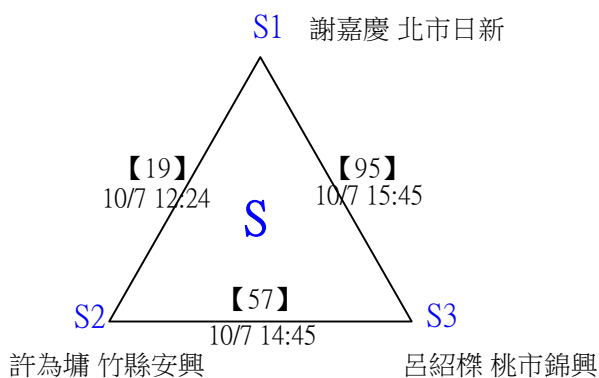
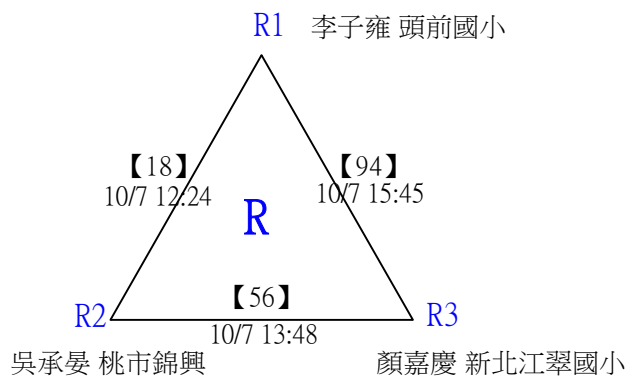
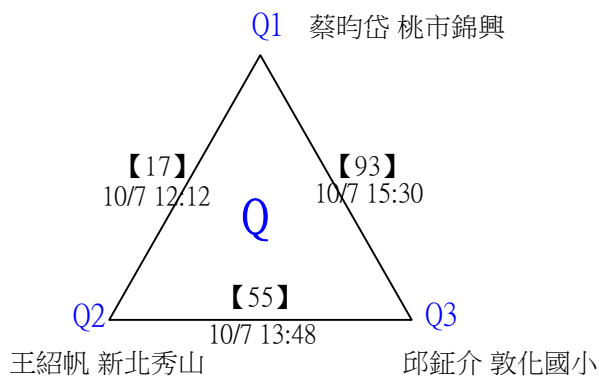

# 2023婕斯羽你同行國小暨親子分齡賽

取16名

國小三年級組男單 共110籤

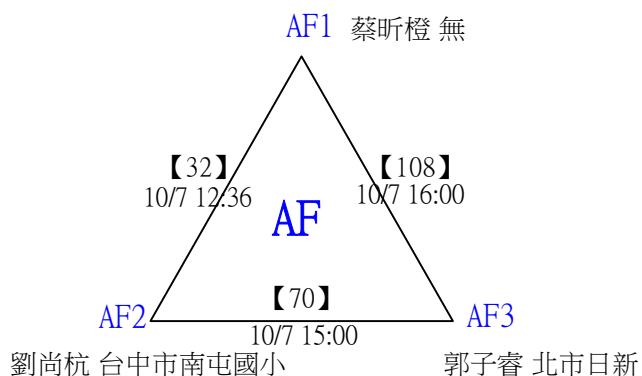
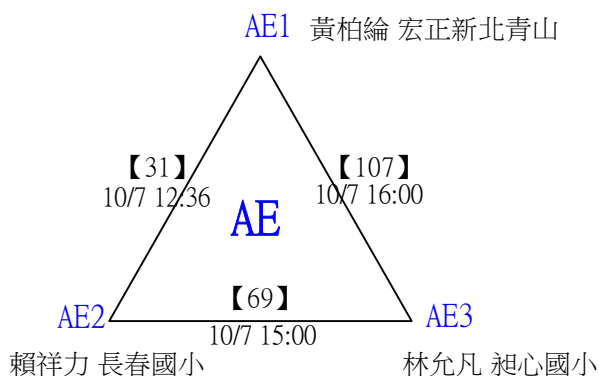
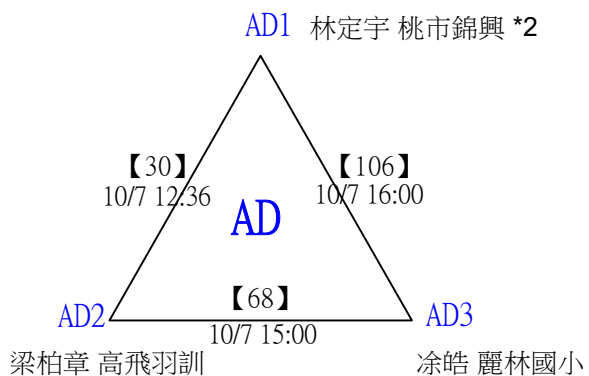
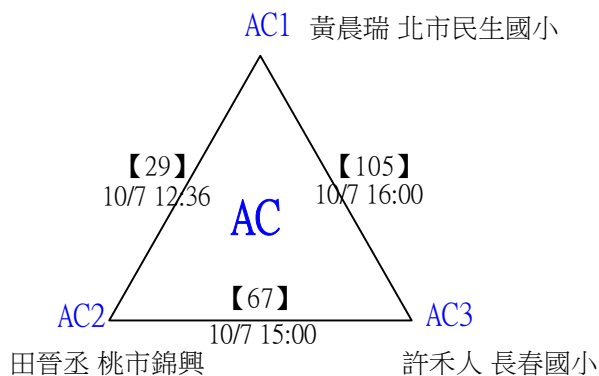
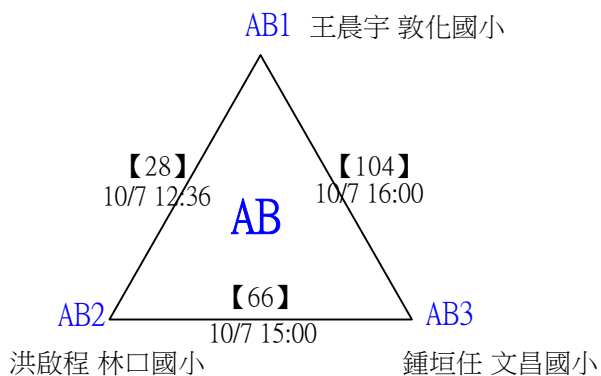
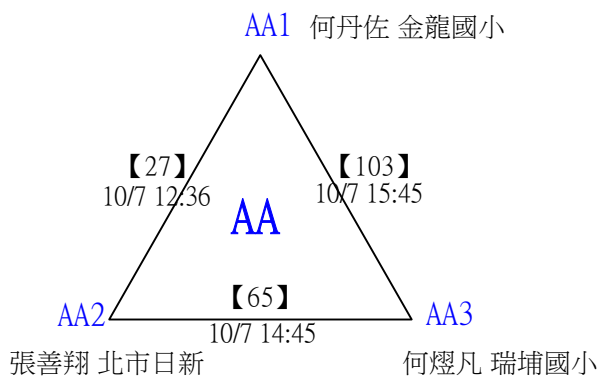
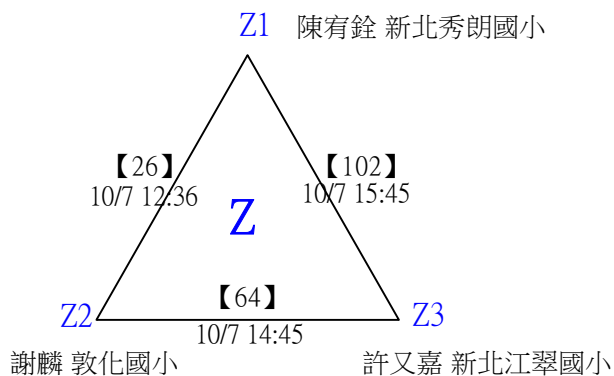
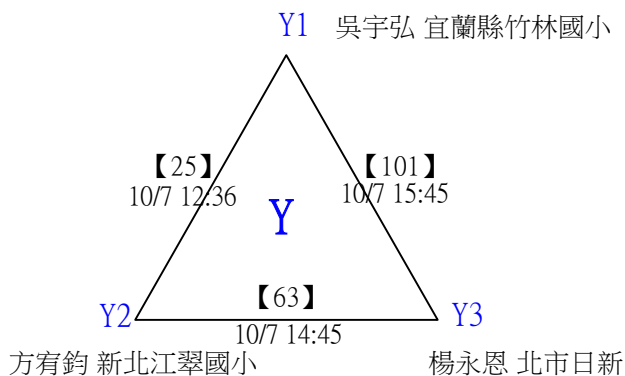

# 2023婕斯羽你同行國小暨親子分齡賽

取16名

國小三年級組男單 共110籤

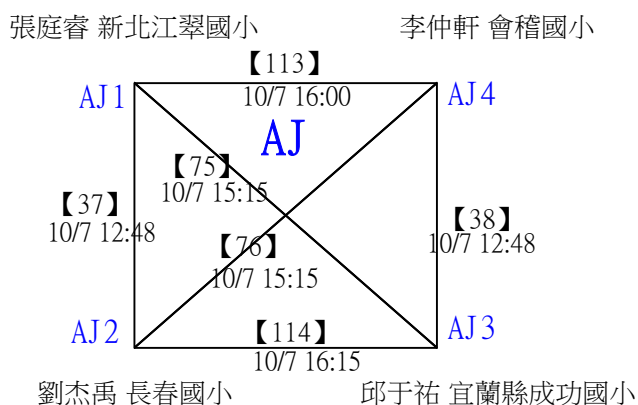
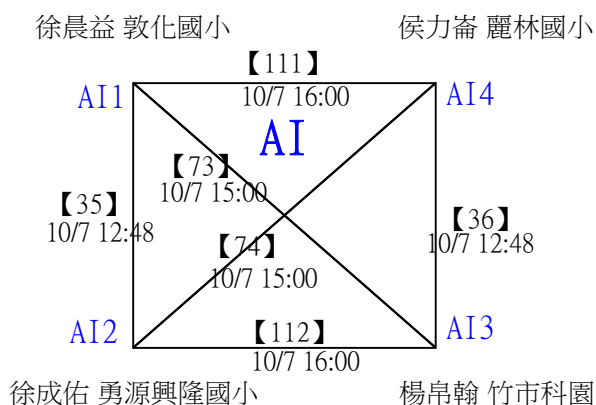
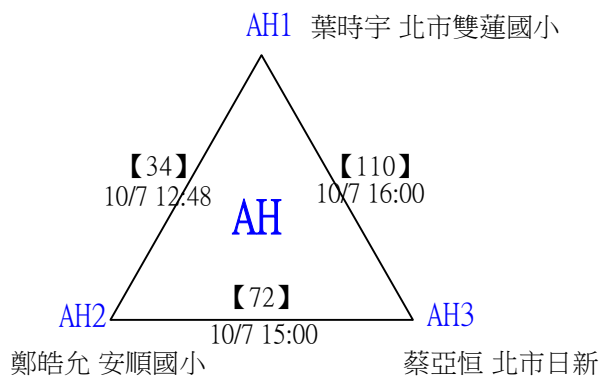
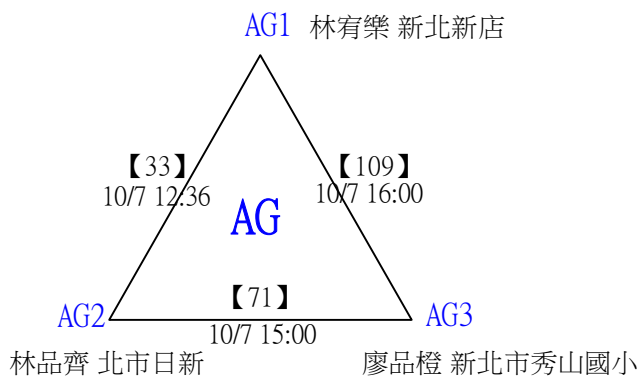



# 2023婕斯羽你同行國小暨親子分齡賽

取16名

國小三年級組男單

決賽：三角取一，四角取二，抽籤決定位置。

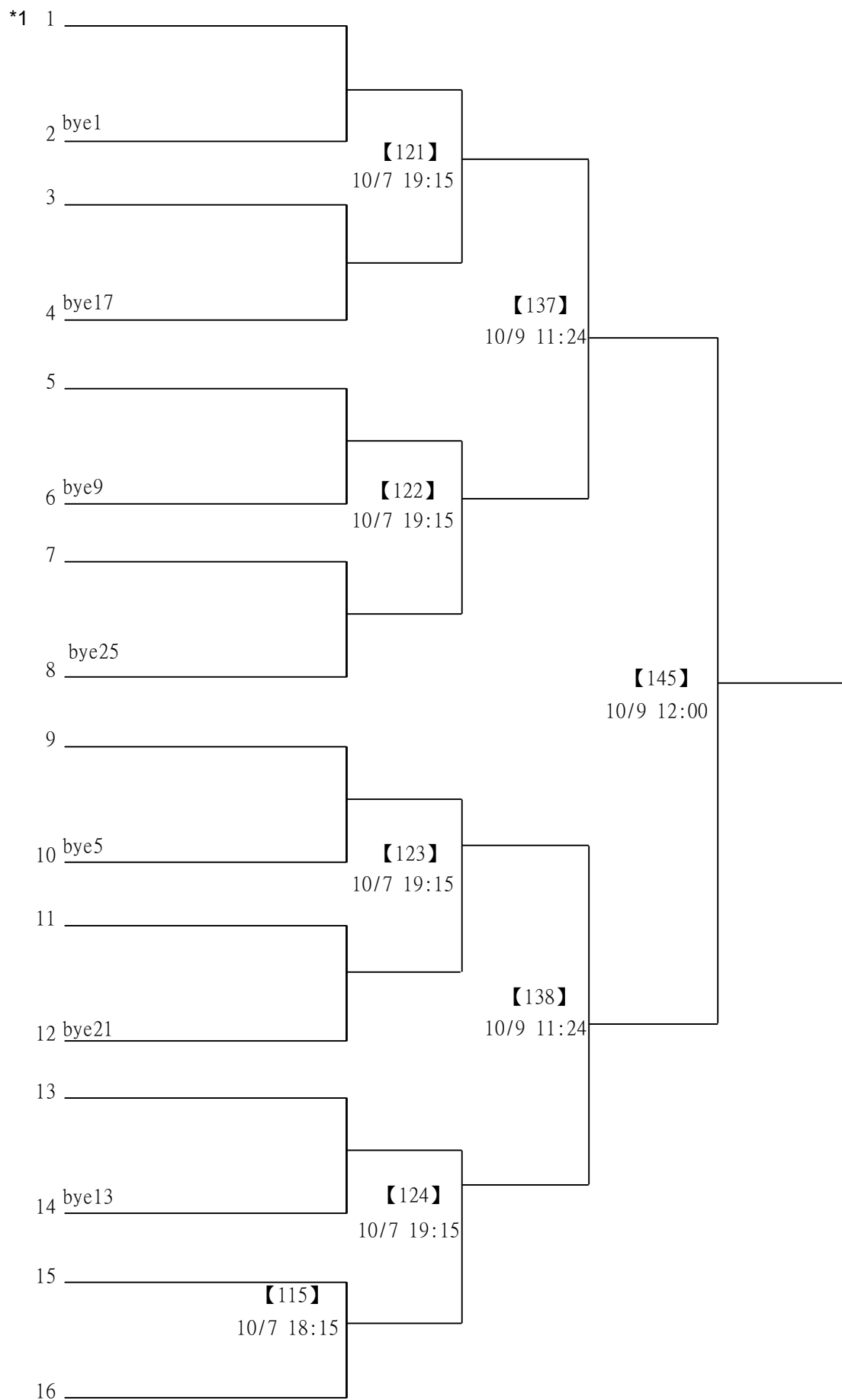

# 2023婕斯羽你同行國小暨親子分齡賽

取16名

國小三年級組男單

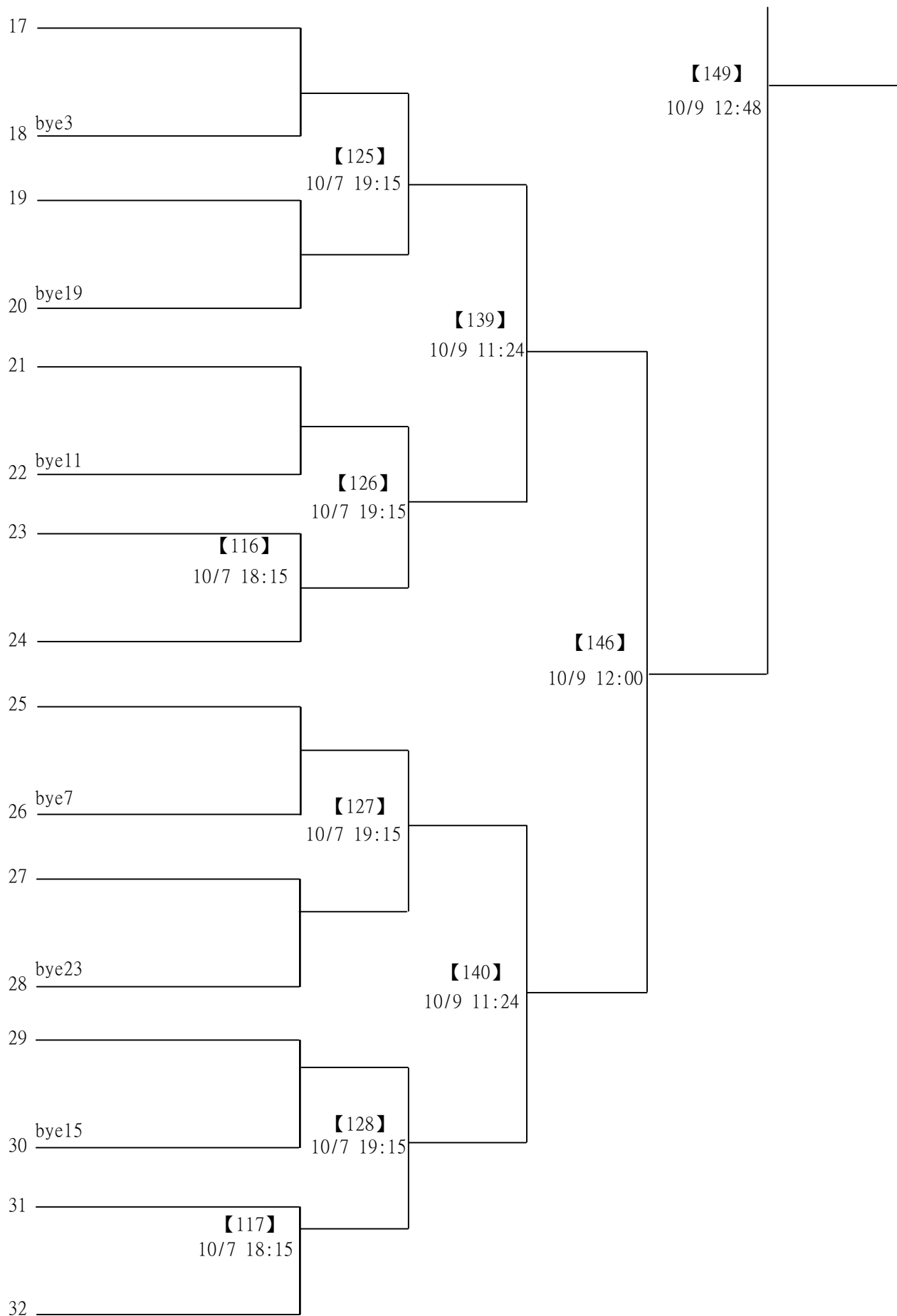

# 2023婕斯羽你同行國小暨親子分齡賽

取16名

國小三年級組男單

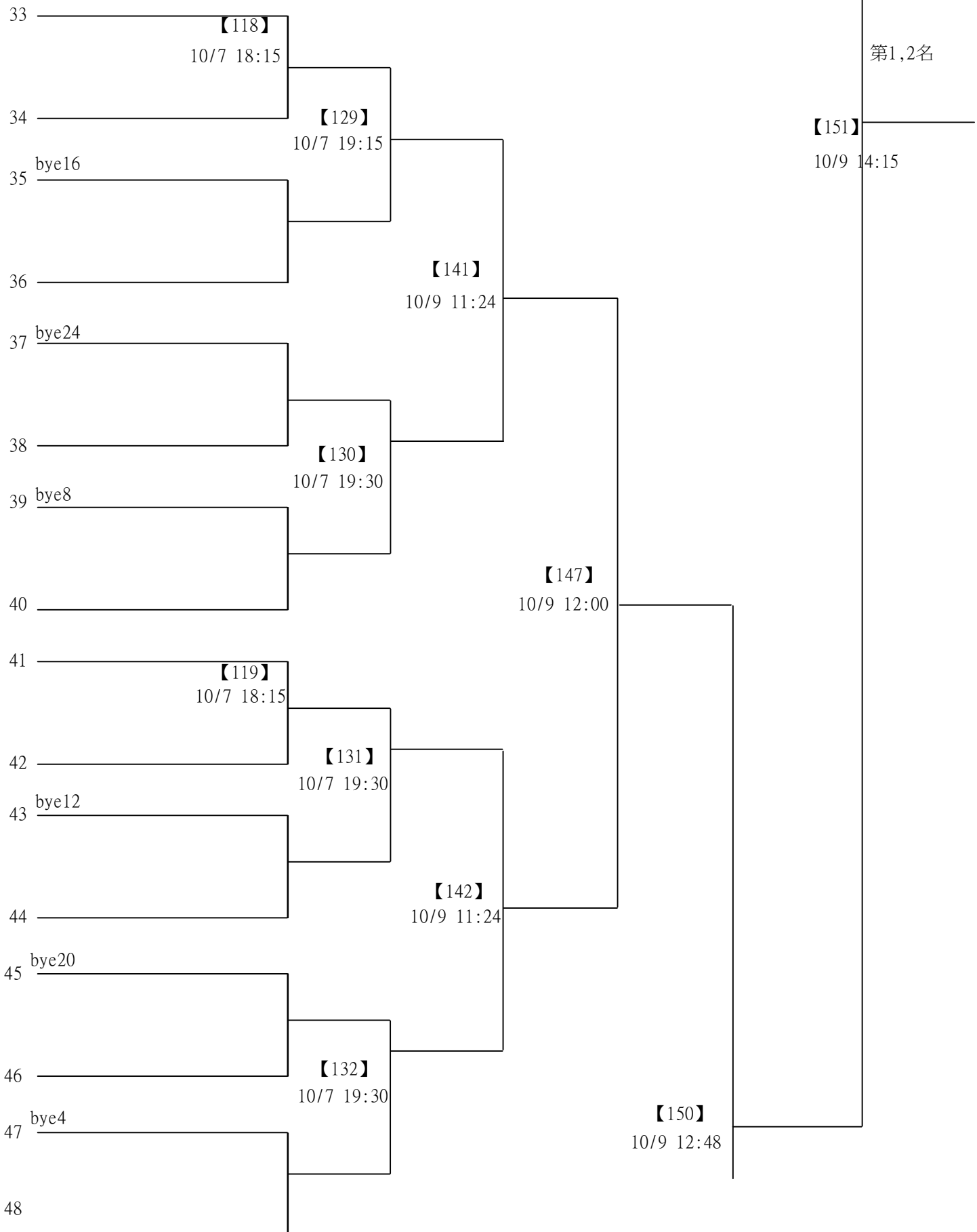

# 2023婕斯羽你同行國小暨親子分齡賽

取16名

國小三年級組男單

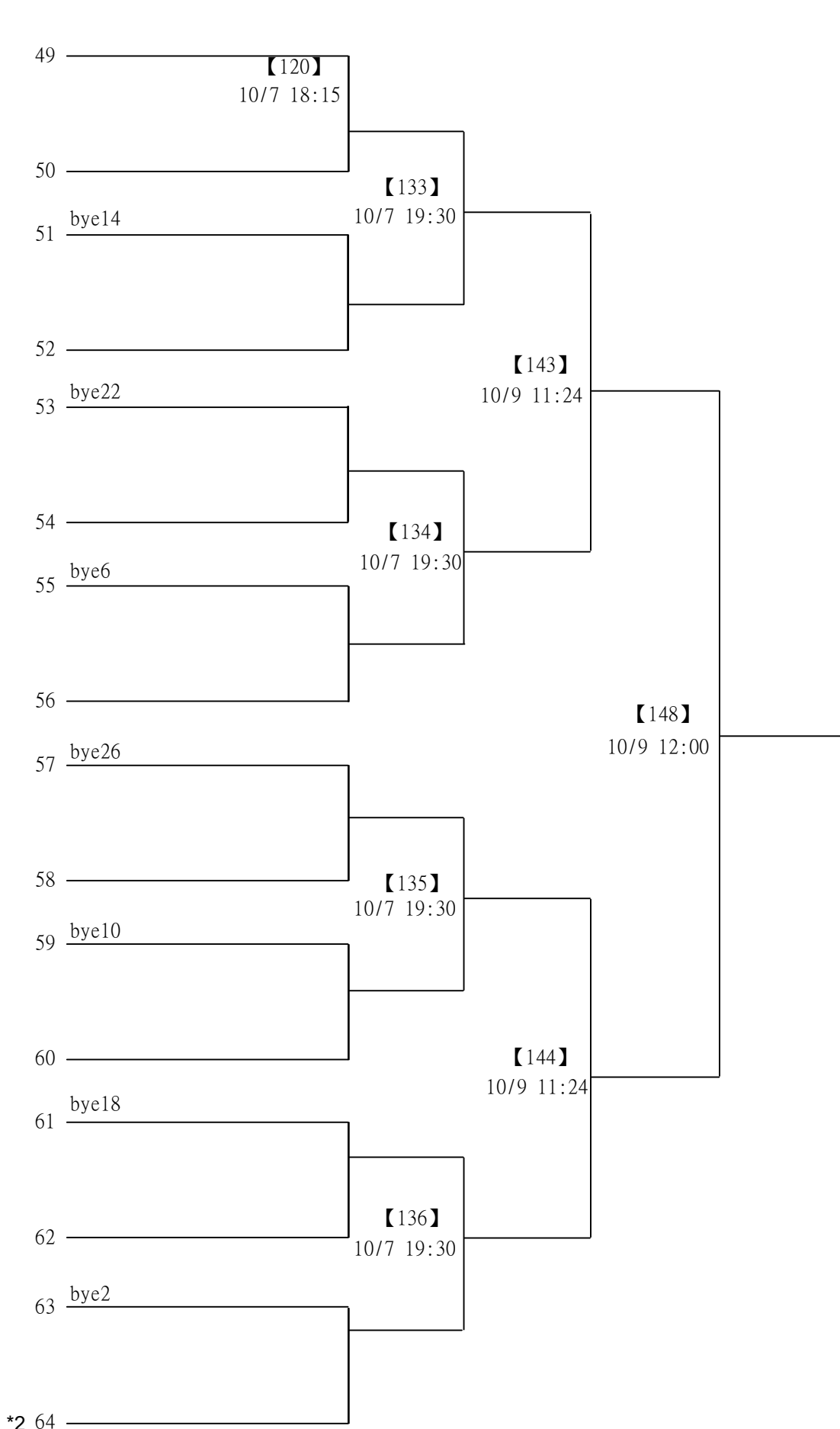

# 2023婕斯羽你同行國小暨親子分齡賽

取8名

國小四年級組女單 共71籤

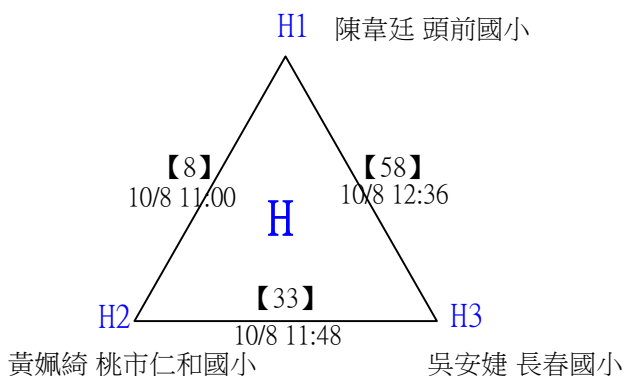
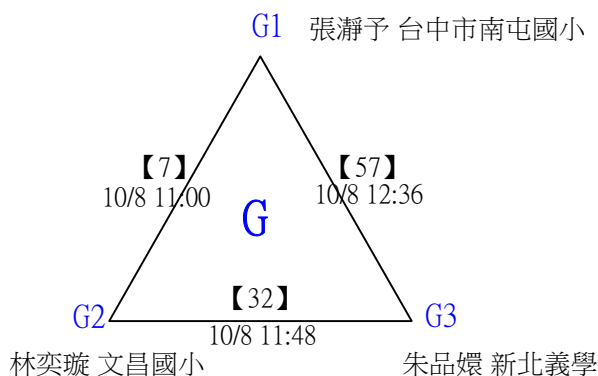
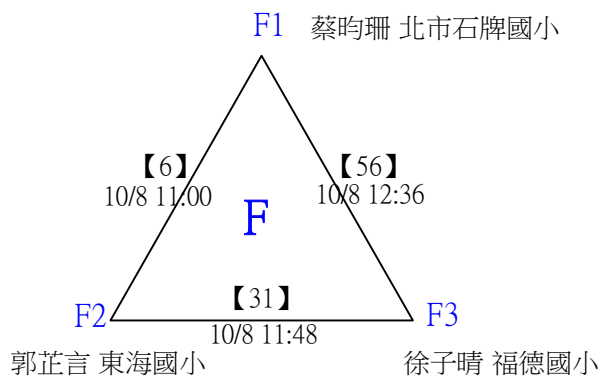
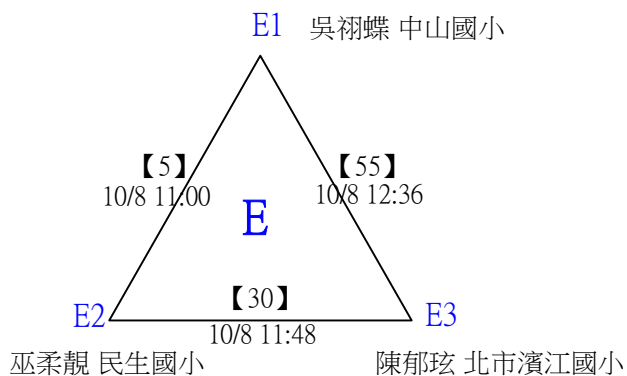
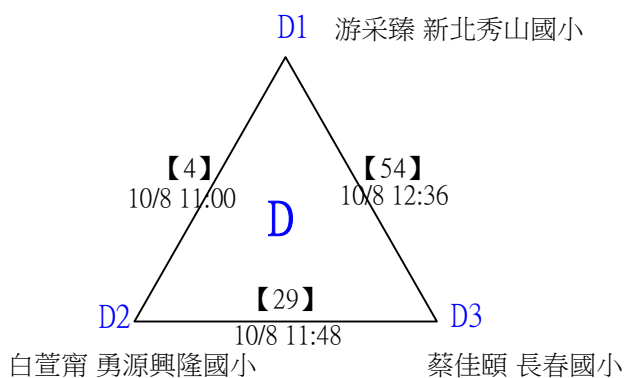
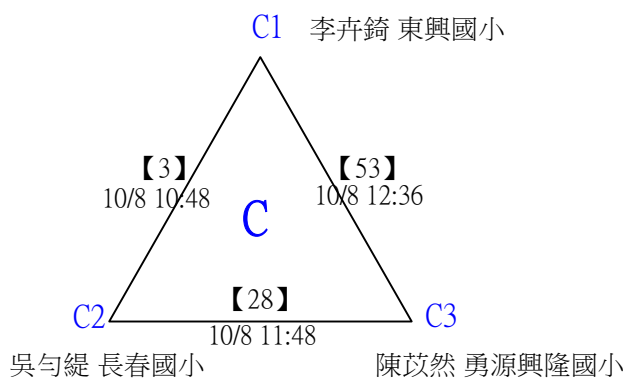
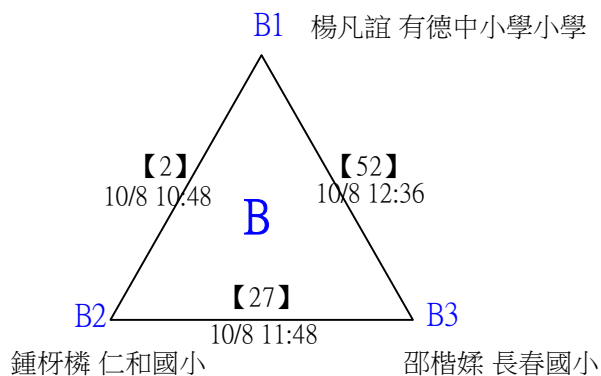
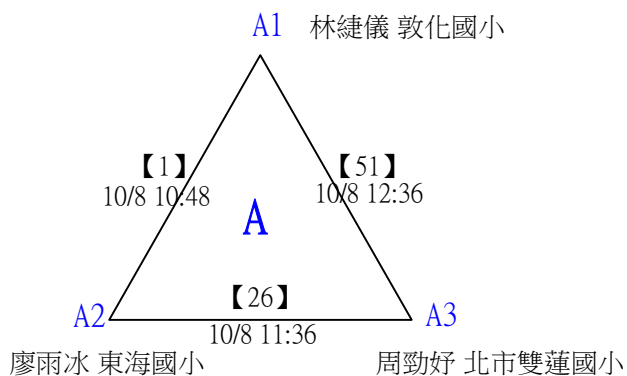

# 2023婕斯羽你同行國小暨親子分齡賽

取8名

國小四年級組女單 共71籤

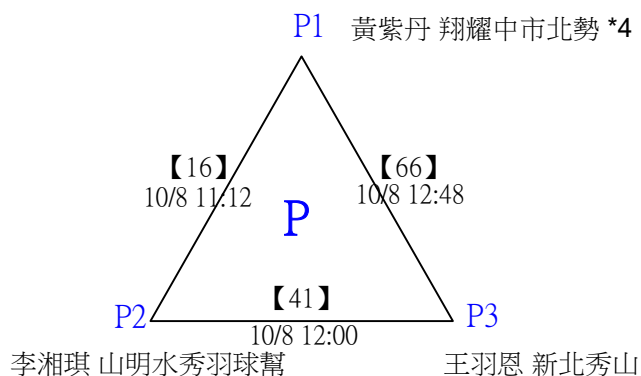
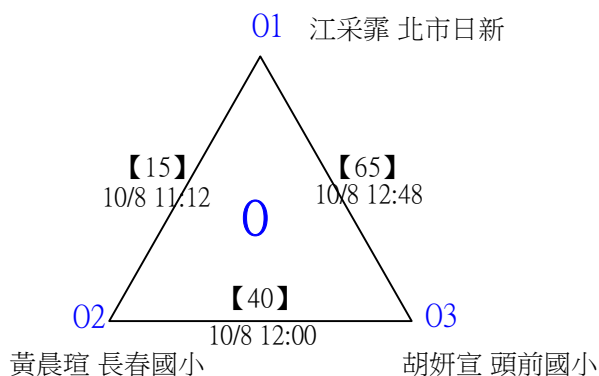
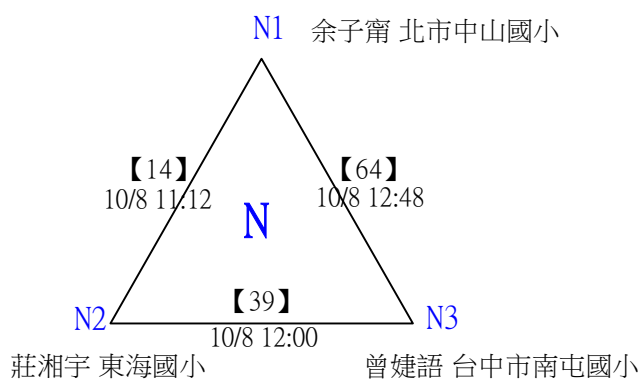
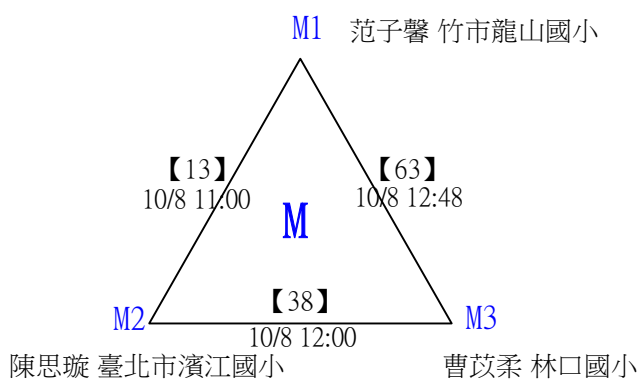
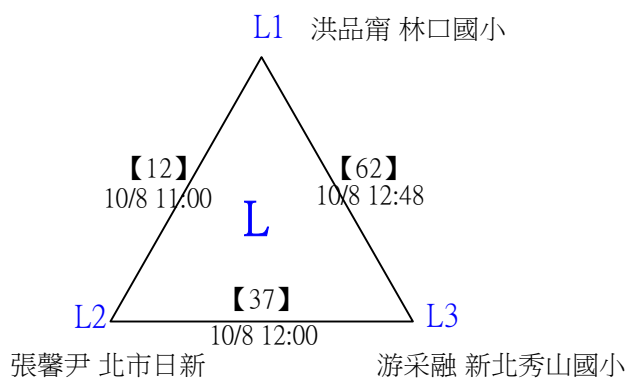
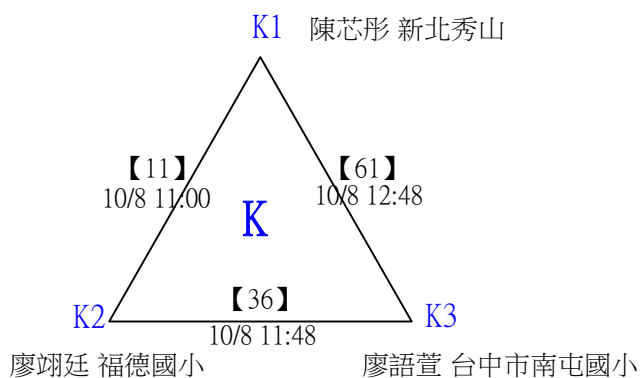
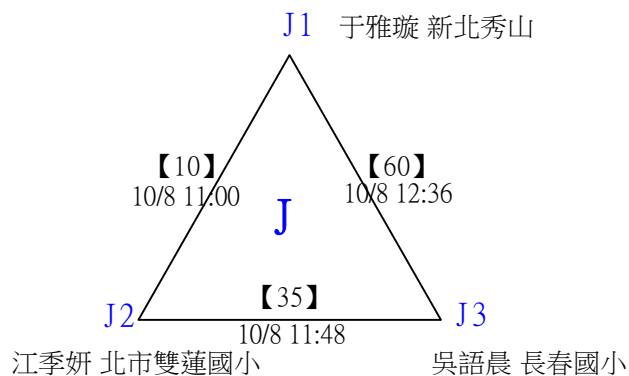
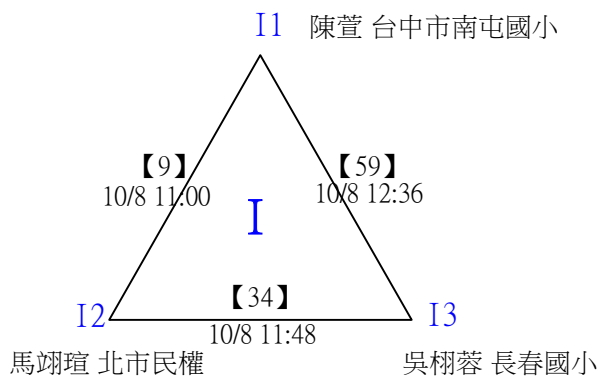

# 2023婕斯羽你同行國小暨親子分齡賽

取8名

國小四年級組女單 共71籤

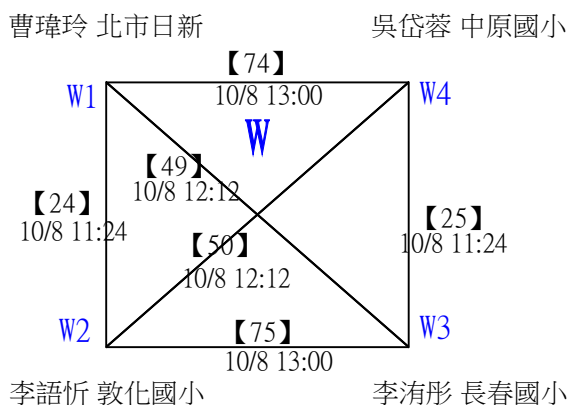
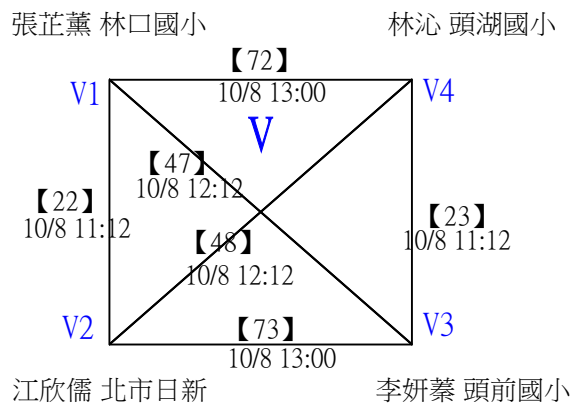
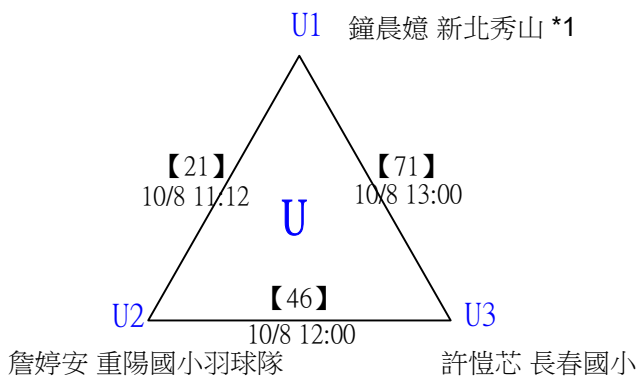
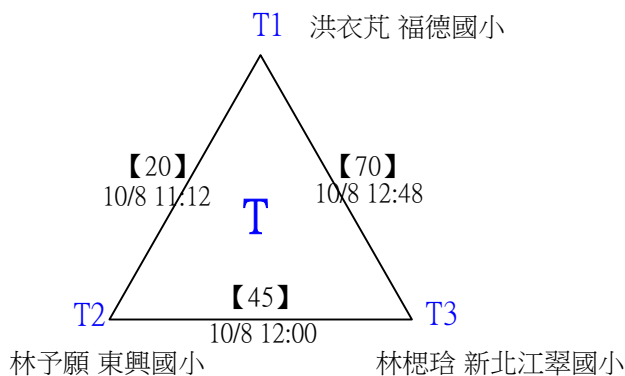
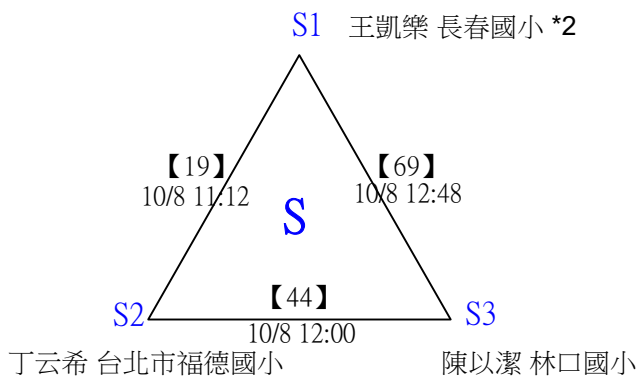
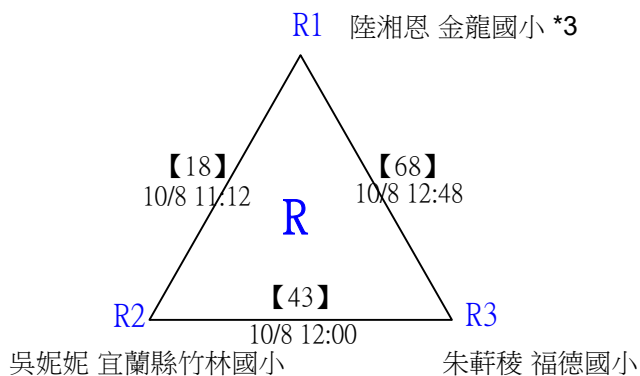
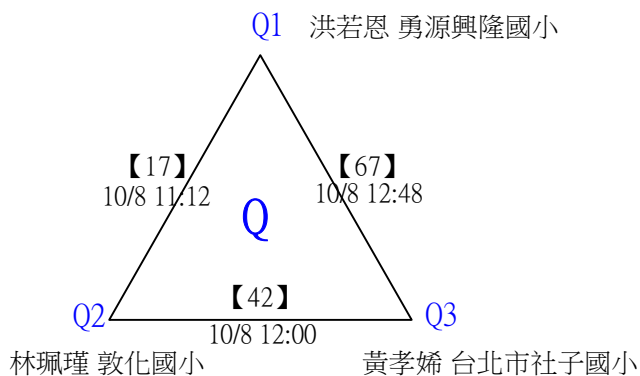

# 2023 婕斯羽你同行 國小暨親子分齡賽

取8名

國小四年級組女單

決賽：三角取一，四角取二，抽籤決定位置。

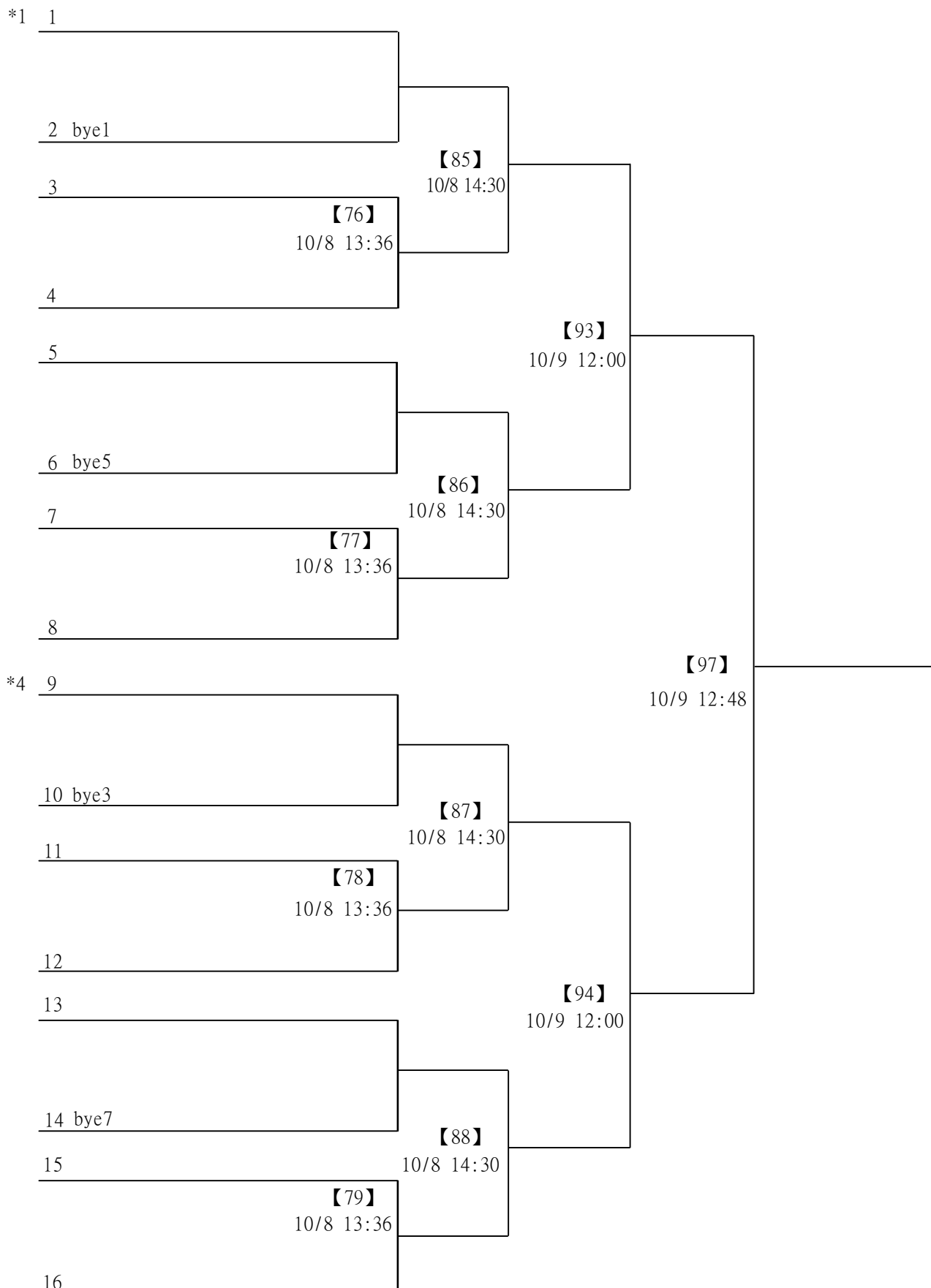



# 2023 婕斯羽你同行 國小暨親子分齡賽

取8名

國小四年級組女單

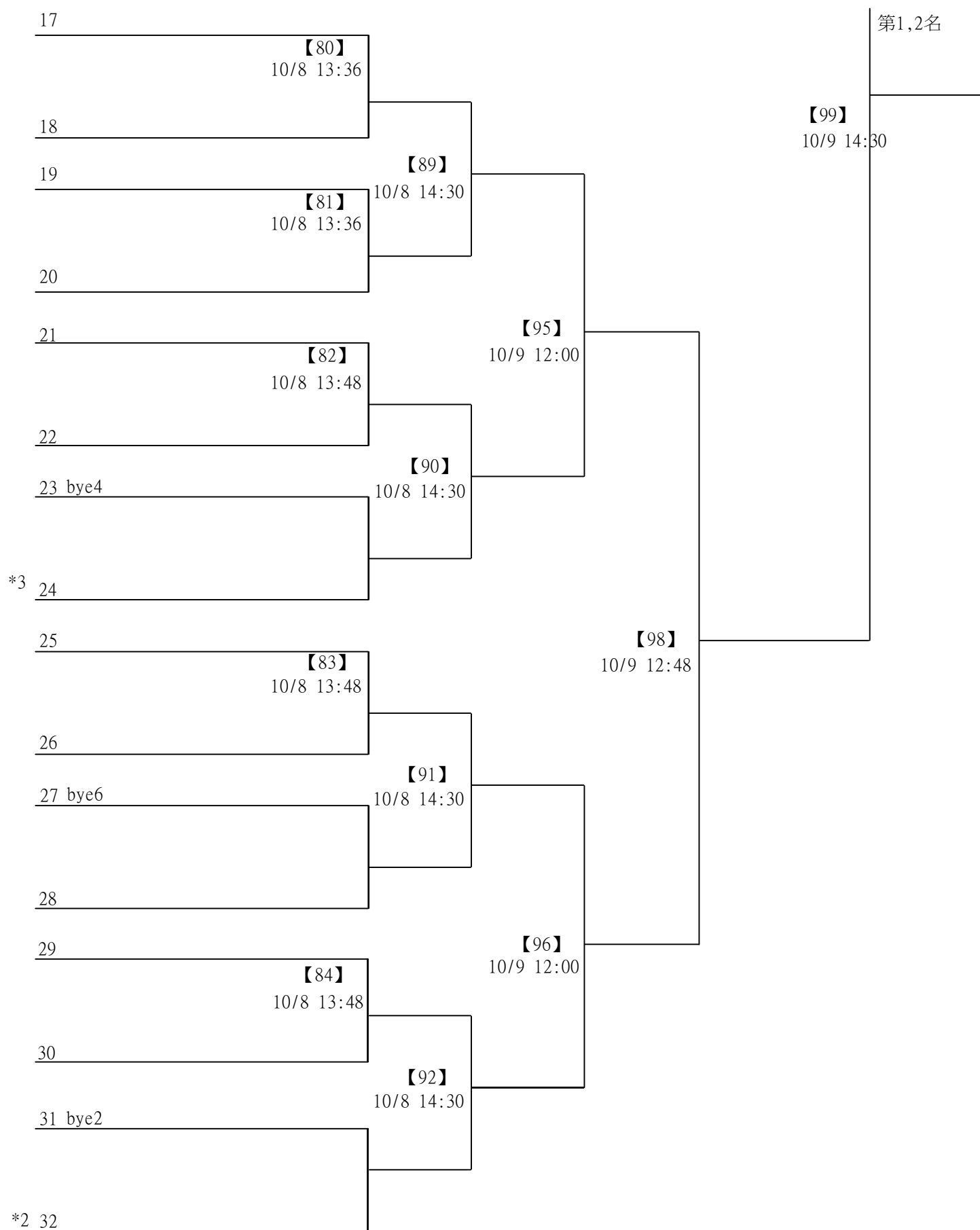

# 2023婕斯羽你同行國小暨親子分齡賽

取16名

國小四年級組男單 共149籤

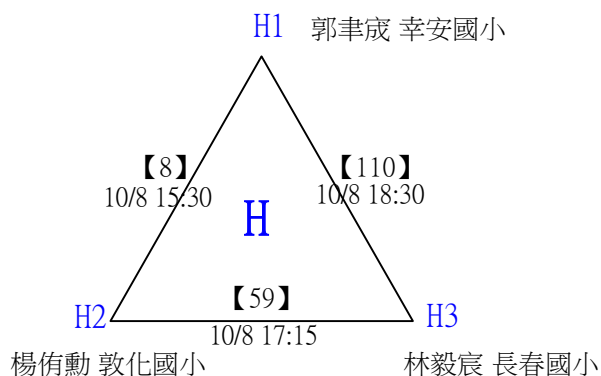
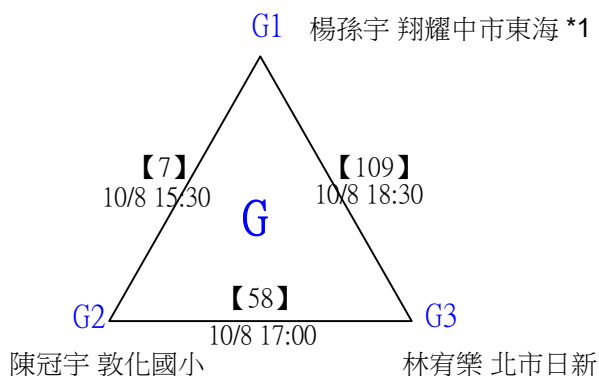
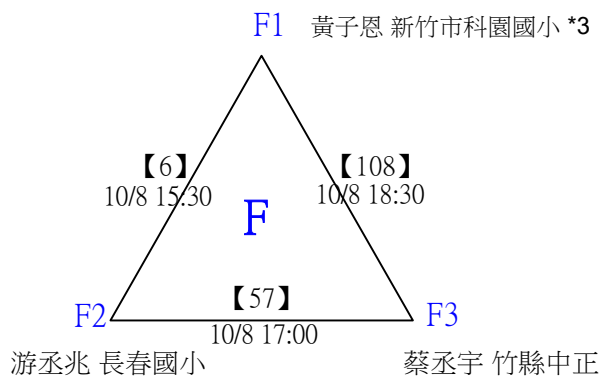
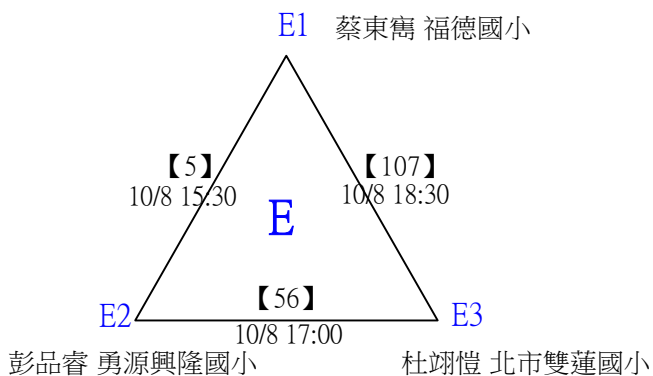
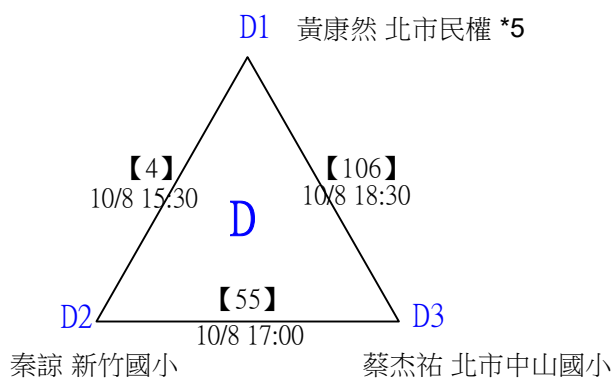
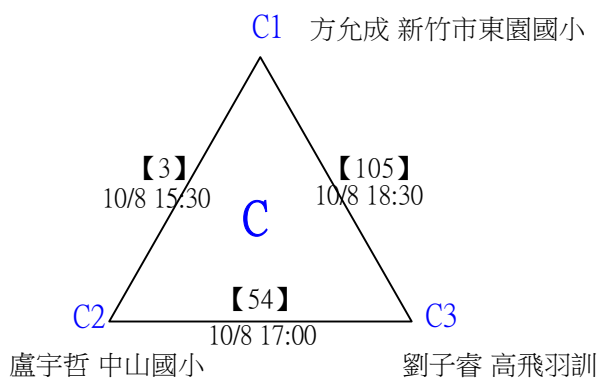
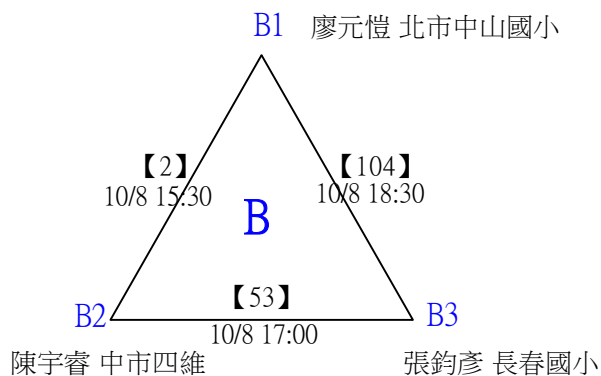
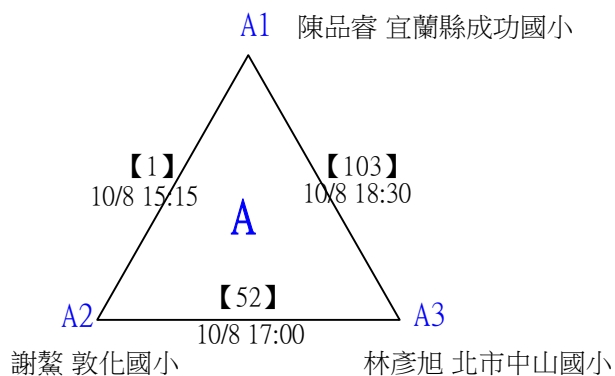

# 2023婕斯羽你同行國小暨親子分齡賽

取16名

國小四年級組男單 共149籤

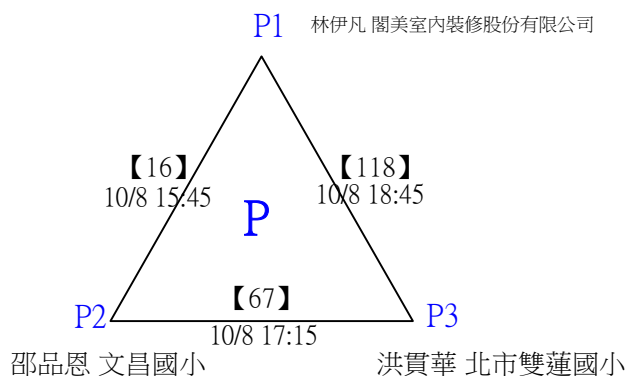
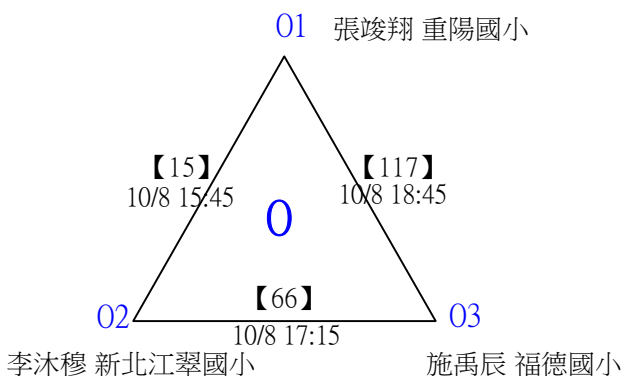
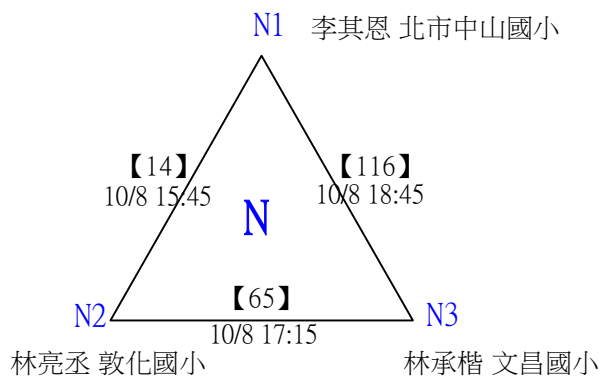
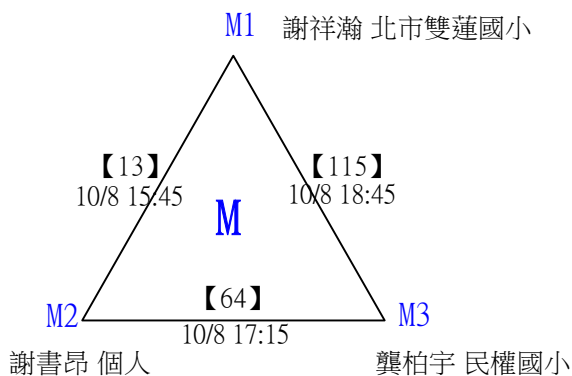
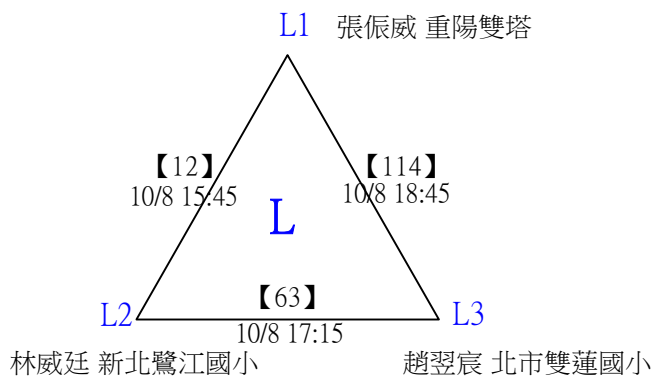
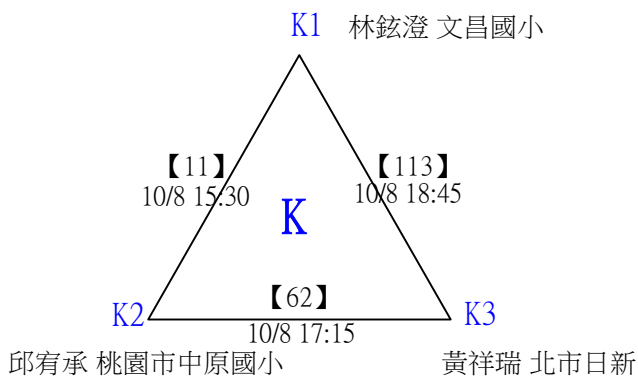
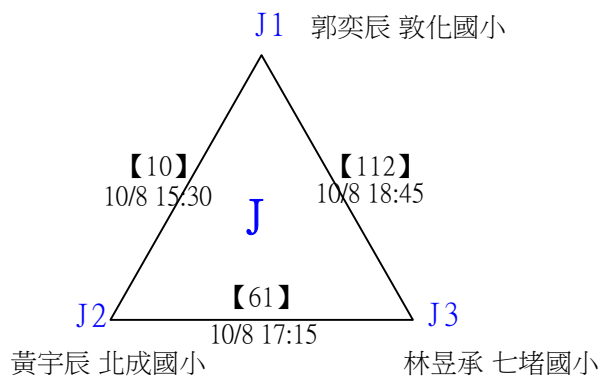
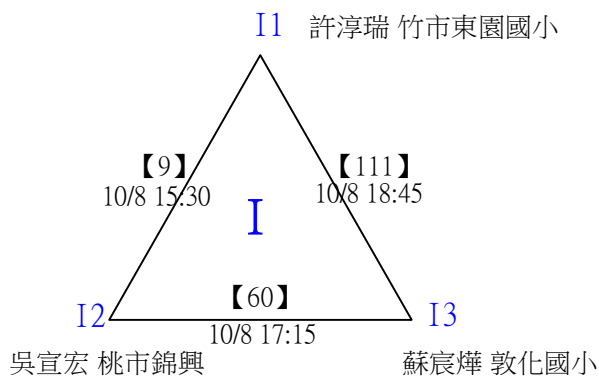

# 2023婕斯羽你同行國小暨親子分齡賽

取16名

國小四年級組男單 共149籤

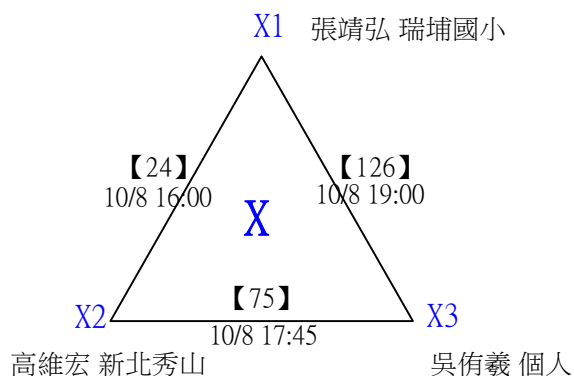
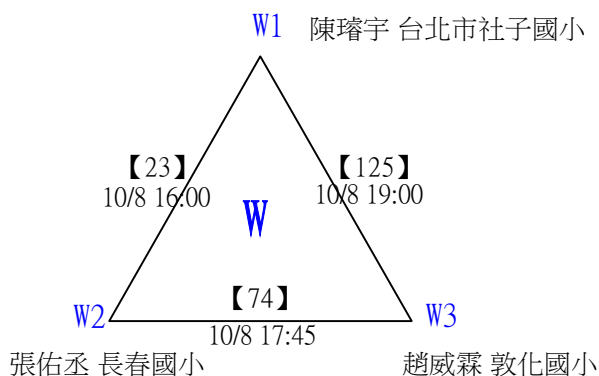
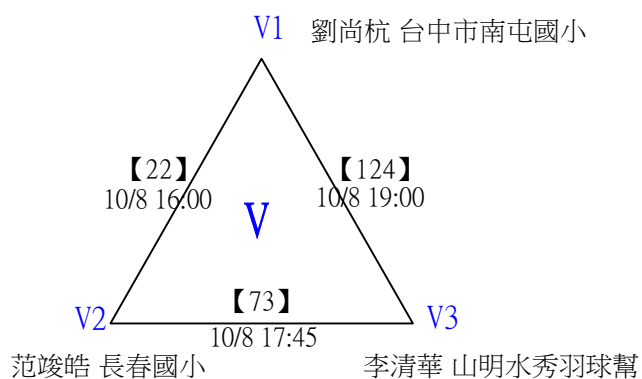
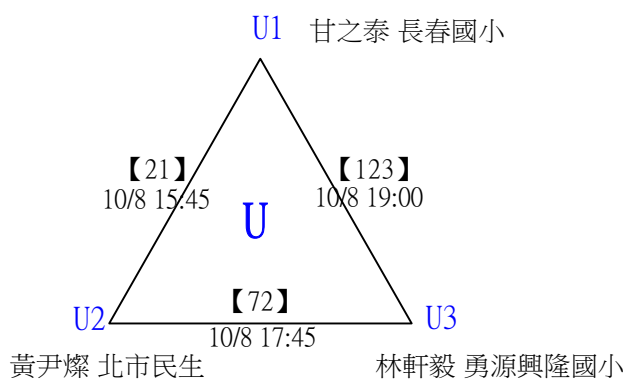
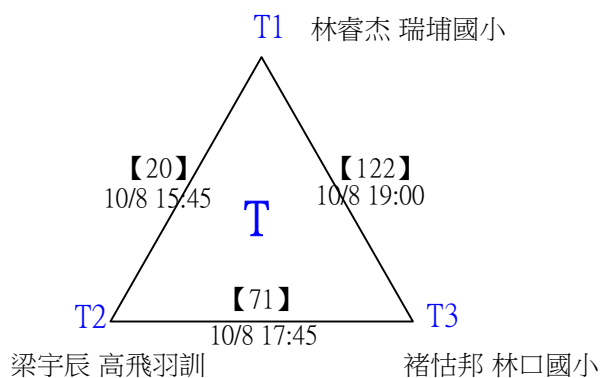
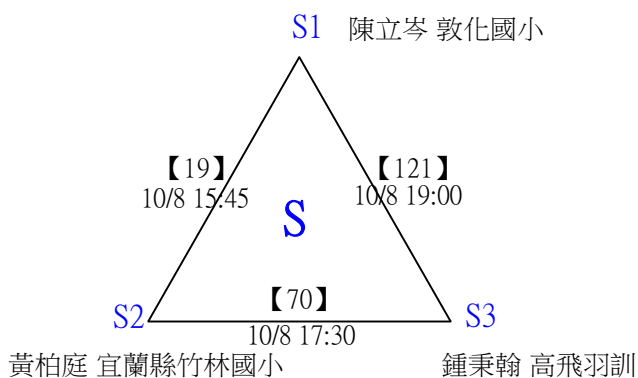
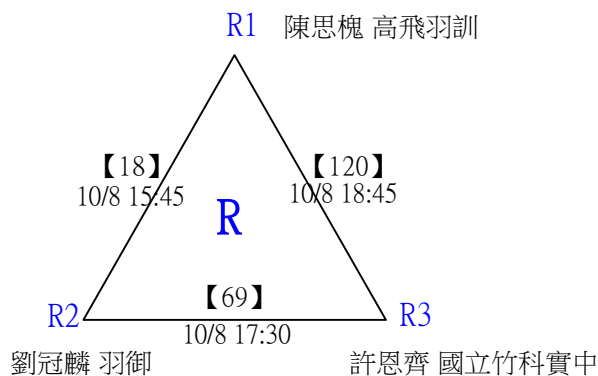
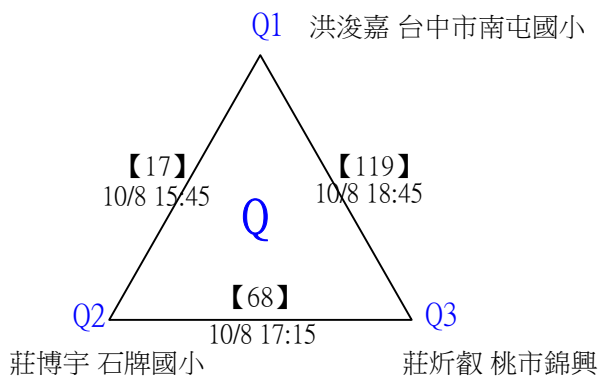

# 2023婕斯羽你同行國小暨親子分齡賽

取16名

國小四年級組男單 共149籤

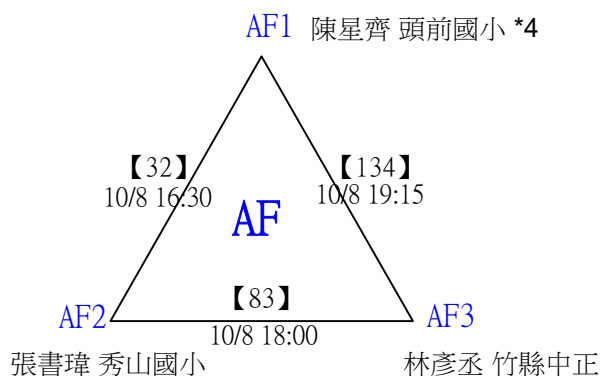
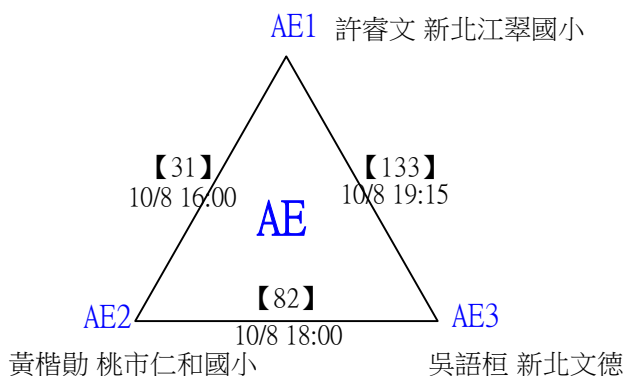
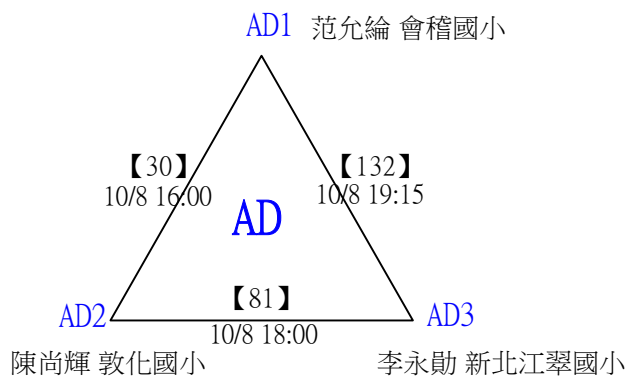
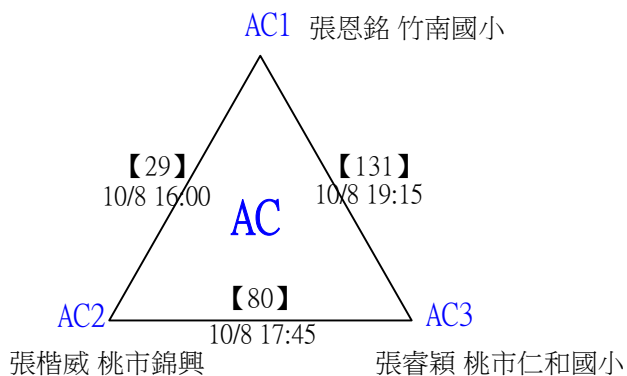
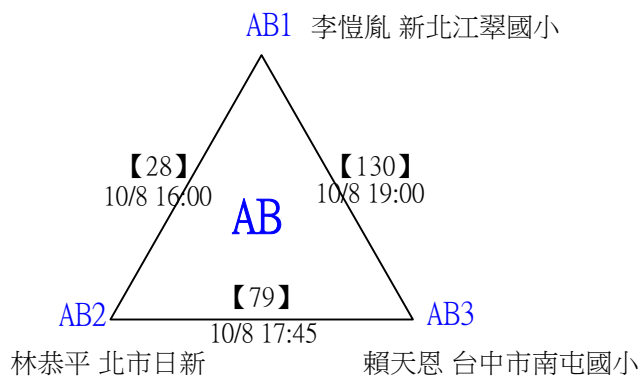
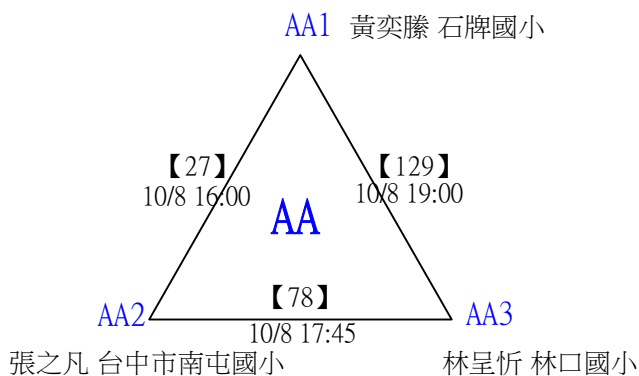
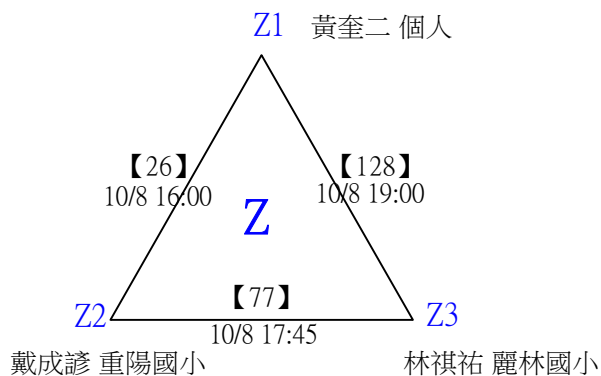
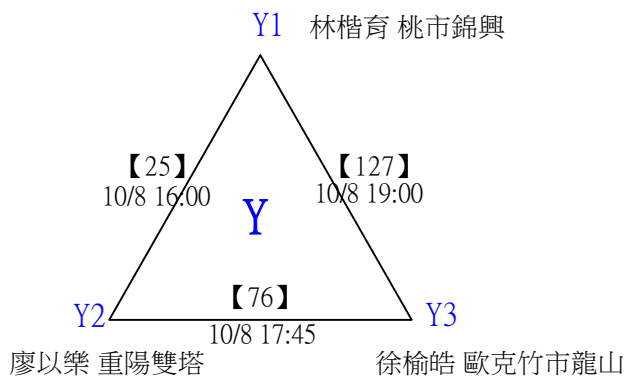

# 2023婕斯羽你同行國小暨親子分齡賽

取16名

國小四年級組男單 共149籤

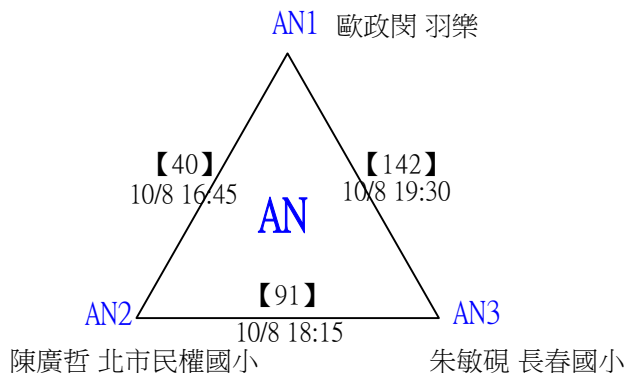
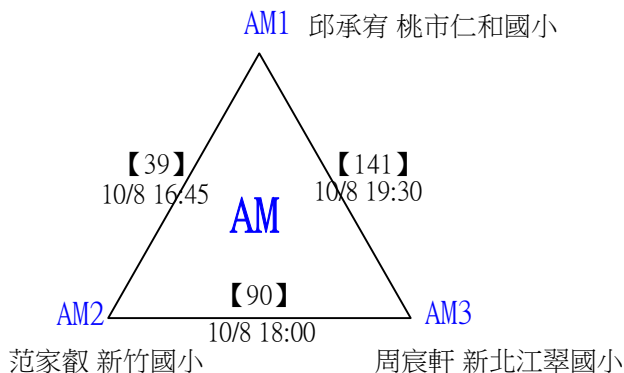
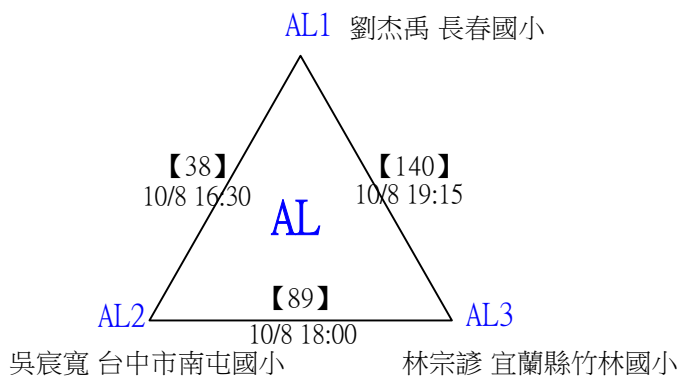
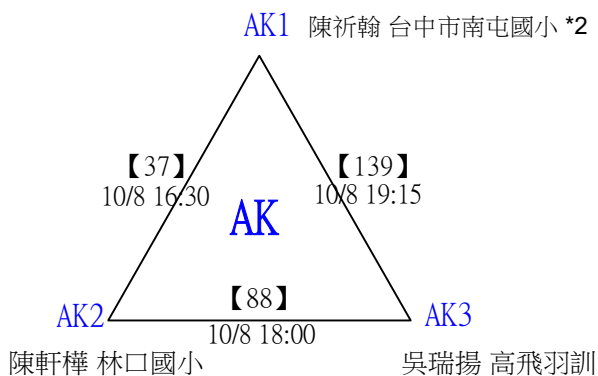
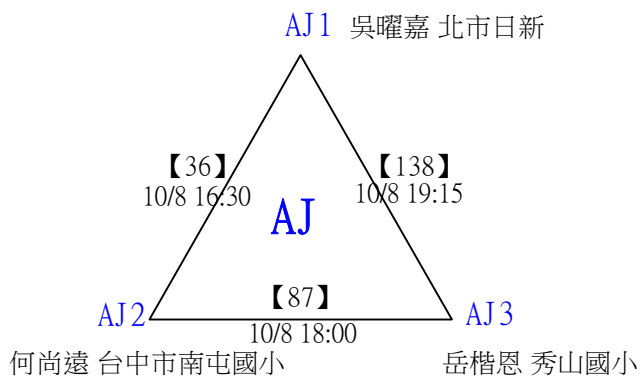
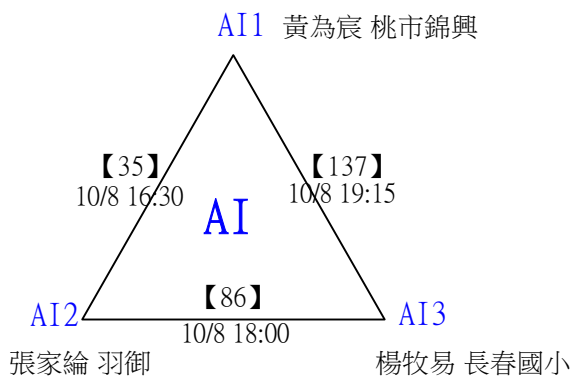
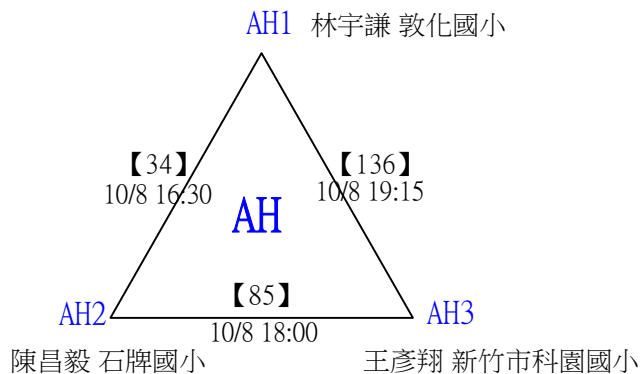
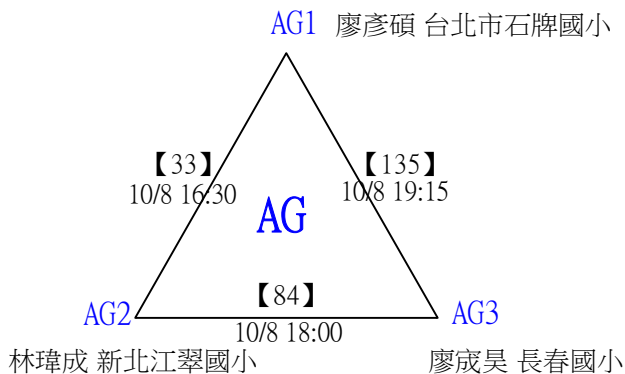

# 2023婕斯羽你同行國小暨親子分齡賽

取16名

國小四年級組男單 共149籤

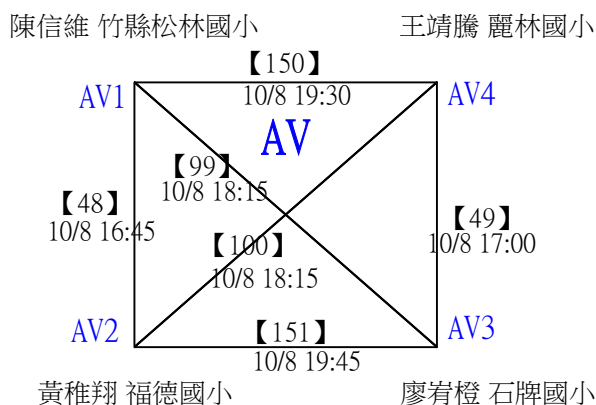
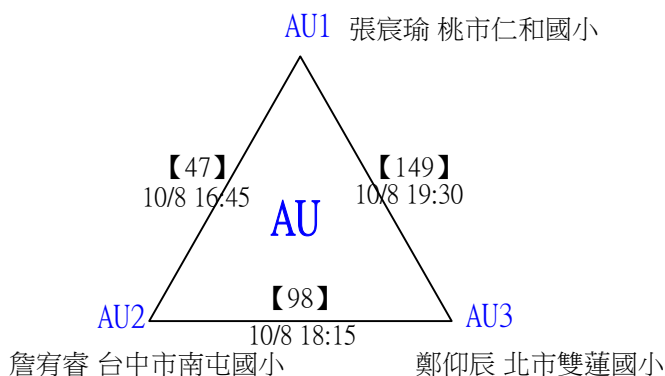
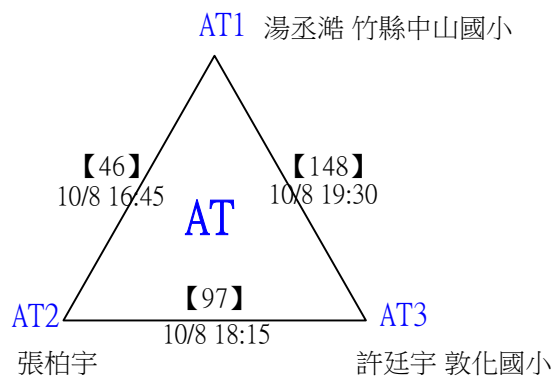
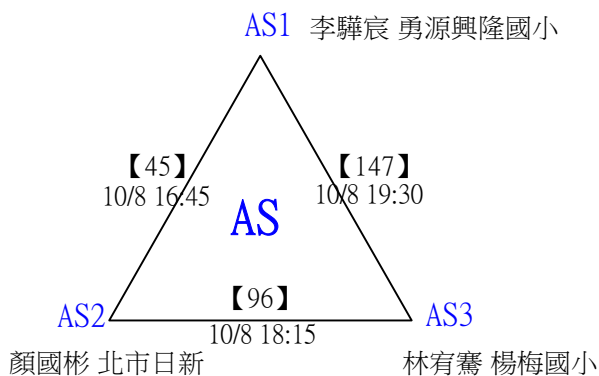
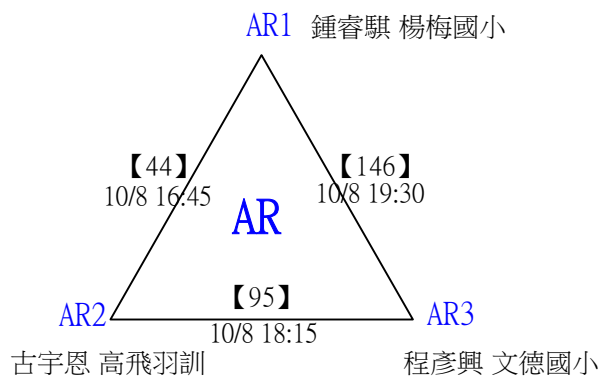
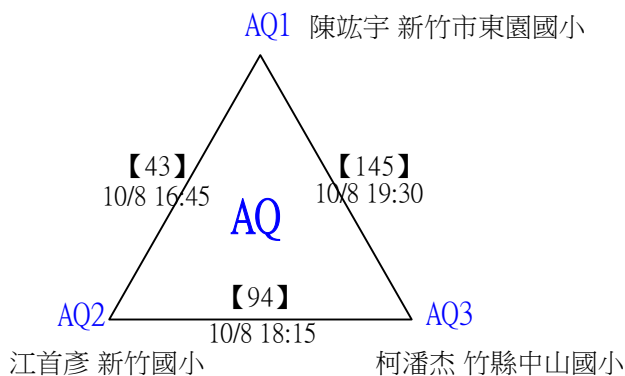
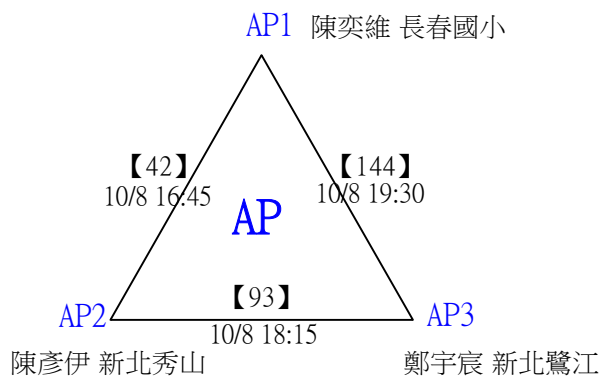
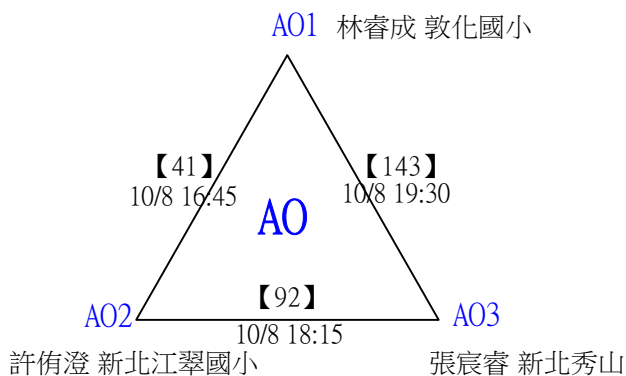

# 2023 婕斯羽你同行 國小暨親子分齡賽

國小四年級組男單 共149籤

取16名

陳奕帆 新竹國小

高楷祐 Tooya

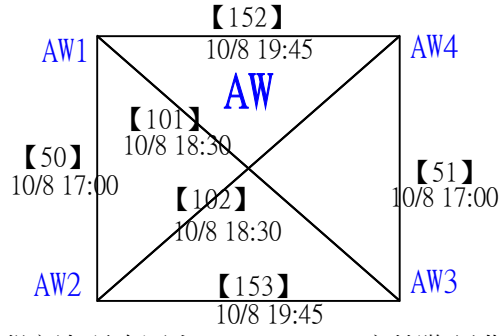

邱奕達 長春國小

唐楚驩 新北秀山



# 2023婕斯羽你同行國小暨親子分齡賽

取16名

國小四年級組男單

決賽：三角取一，四角取二，抽籤決定位置。

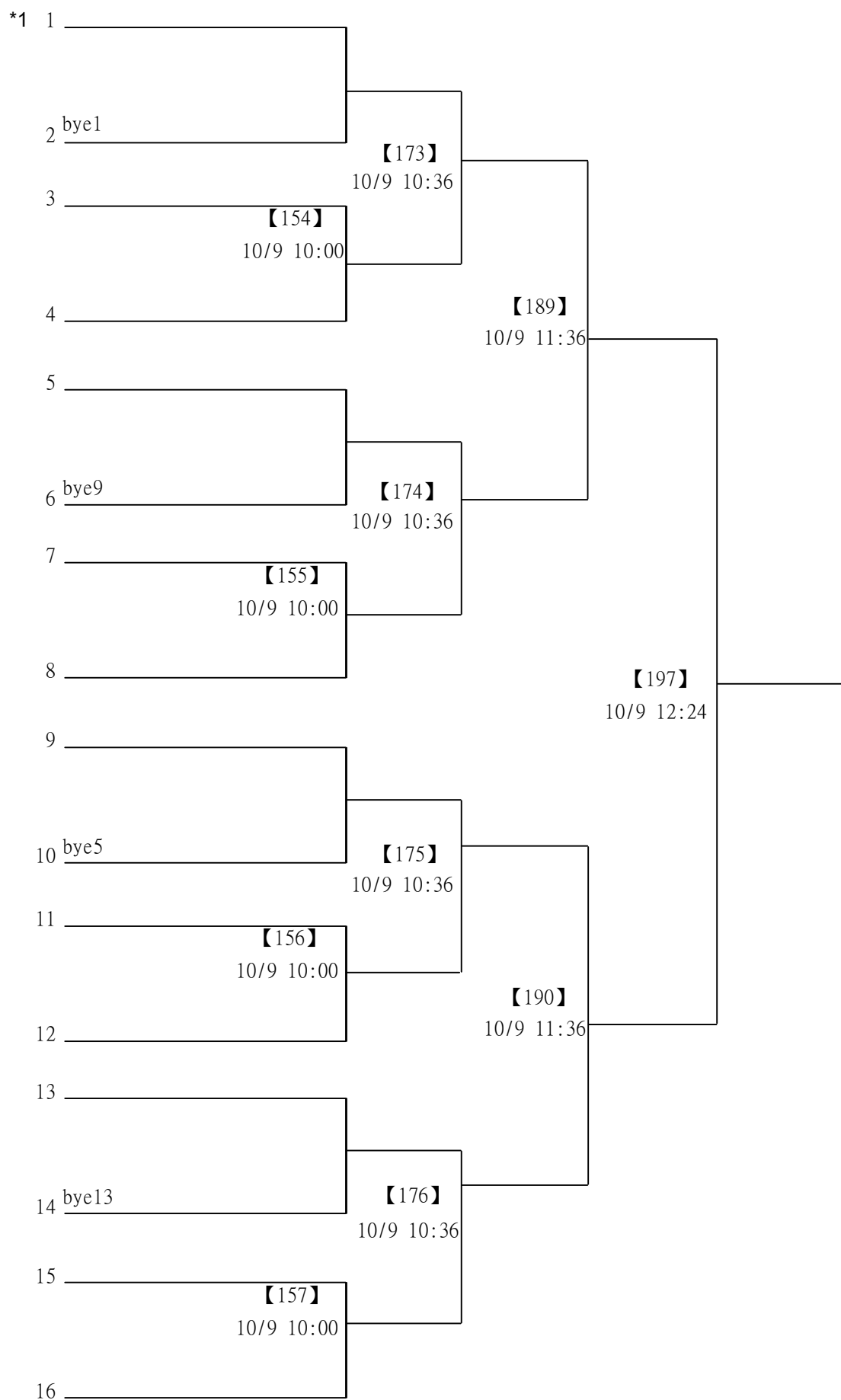

# 2023婕斯羽你同行國小暨親子分齡賽

取16名

國小四年級組男單

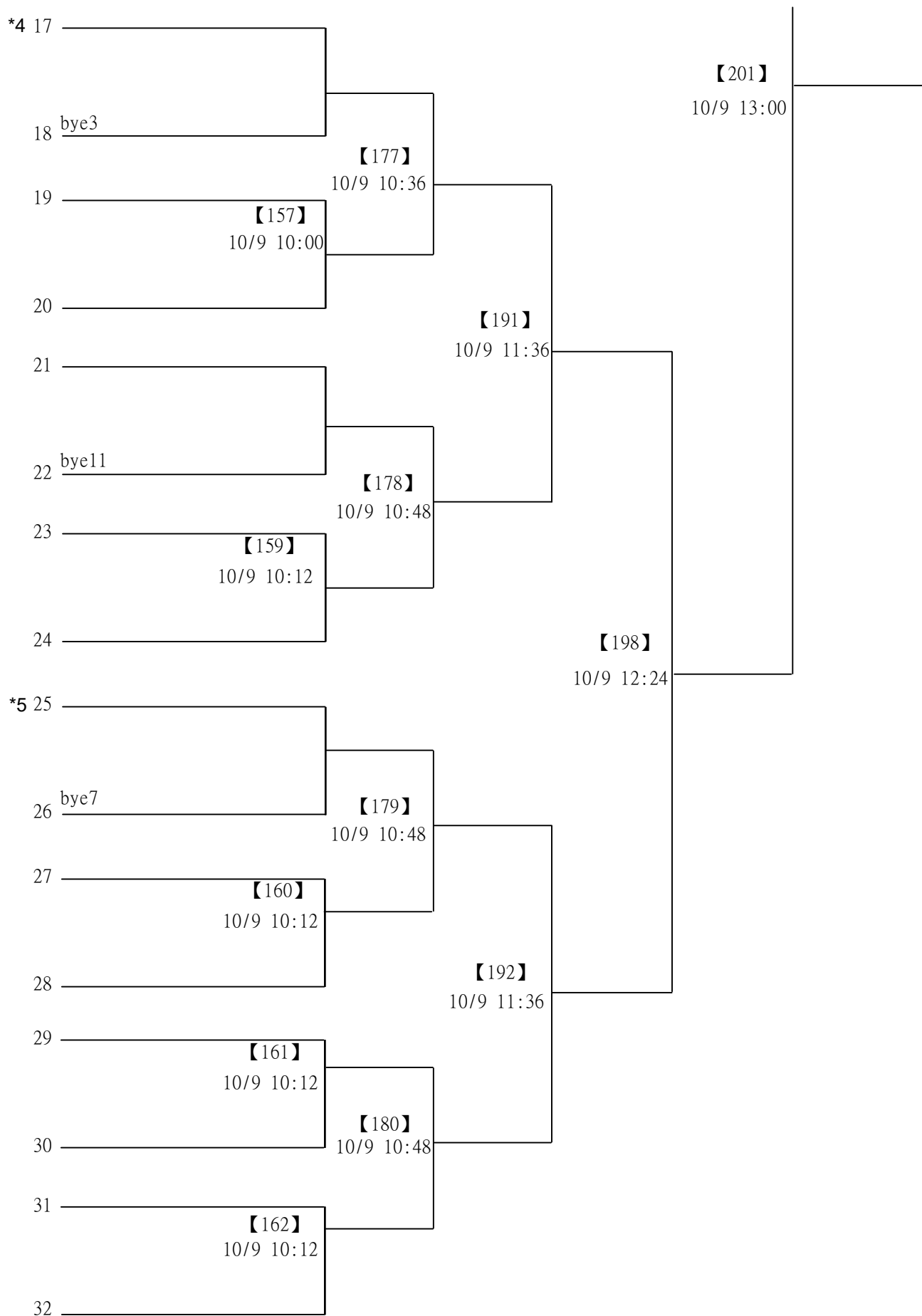

# 2023婕斯羽你同行國小暨親子分齡賽

取16名

國小四年級組男單

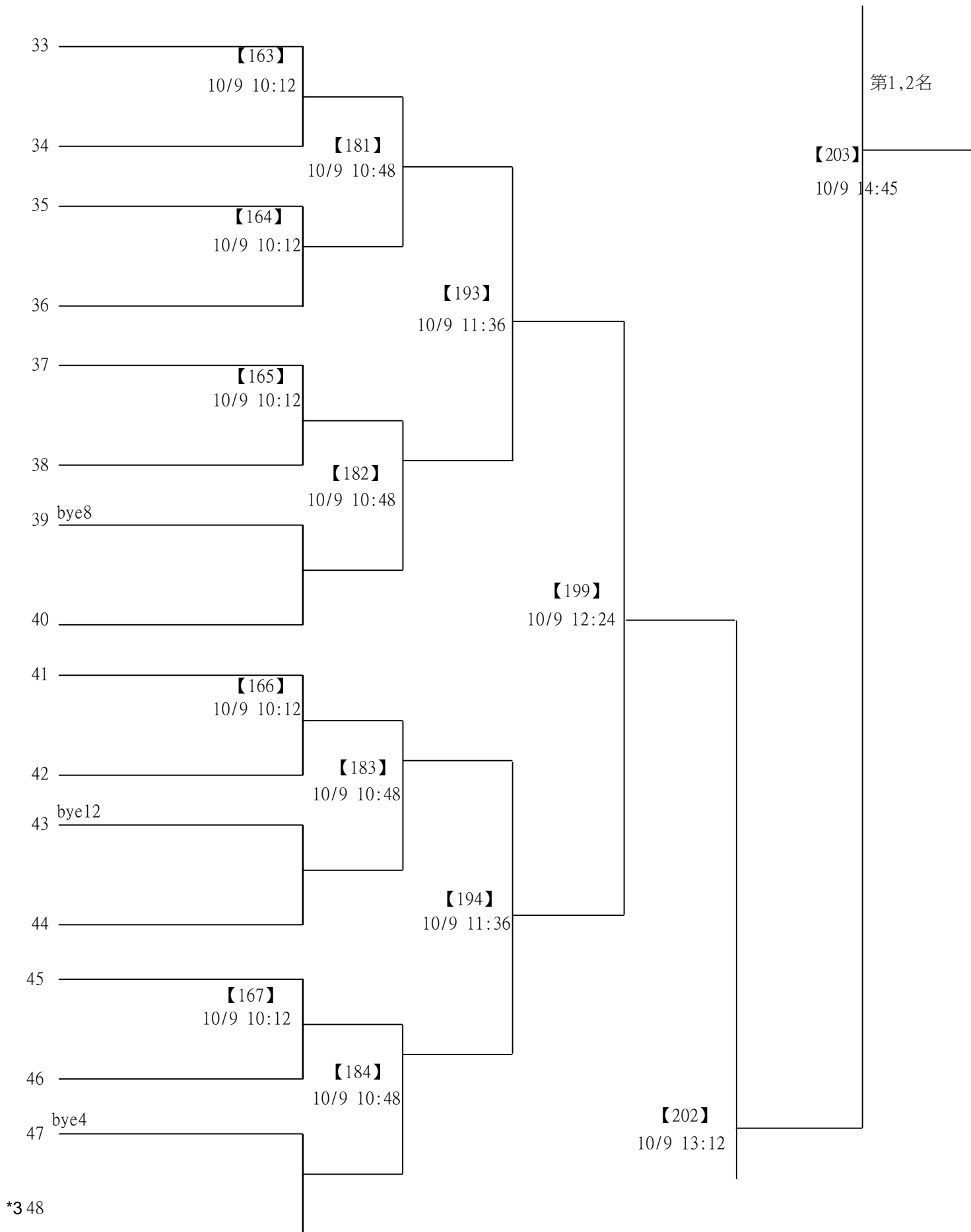

# 2023婕斯羽你同行國小暨親子分齡賽

取16名

國小四年級組男單

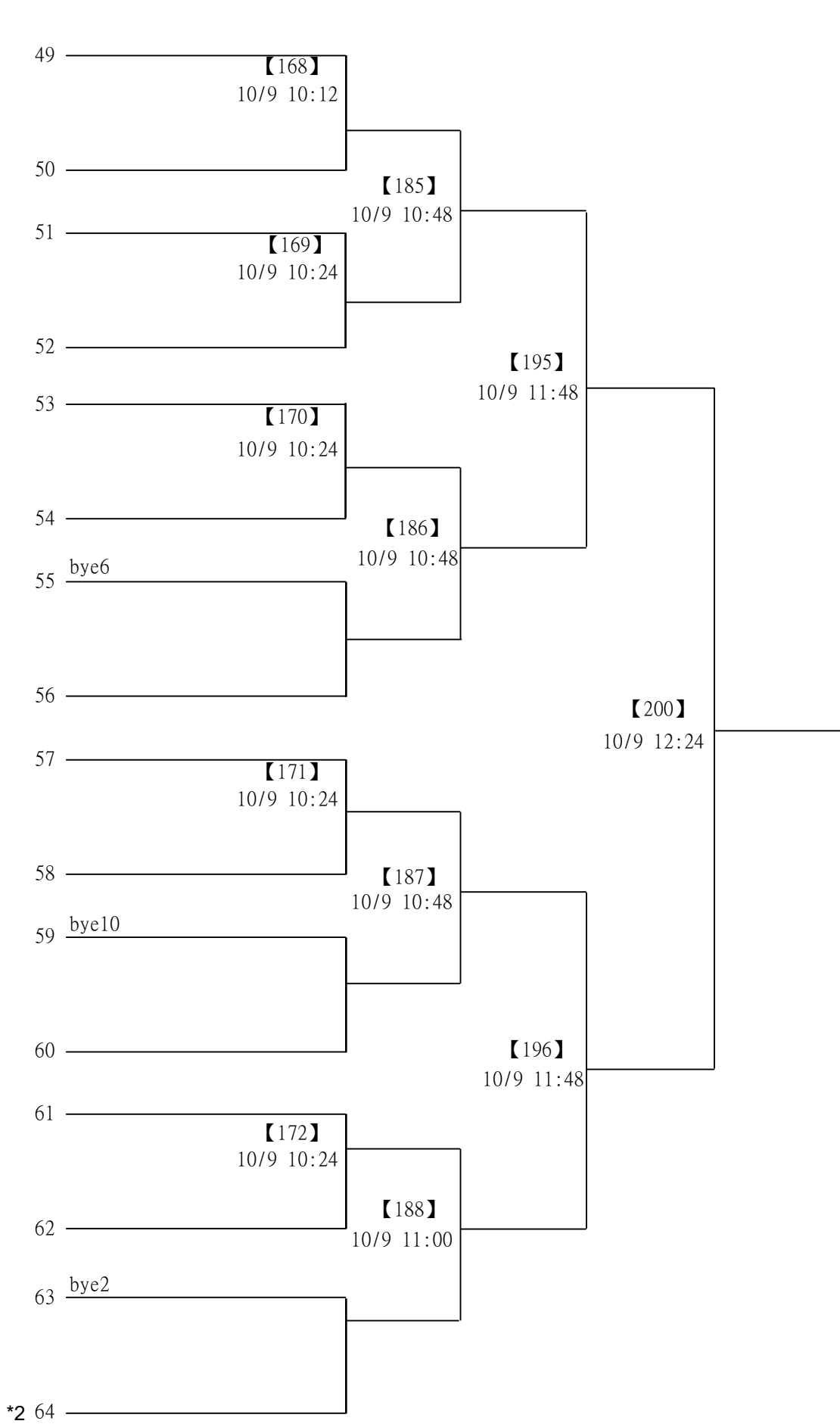

# 2023婕斯羽你同行國小暨親子分齡賽

取16名

國小五年級組女單 共90籤

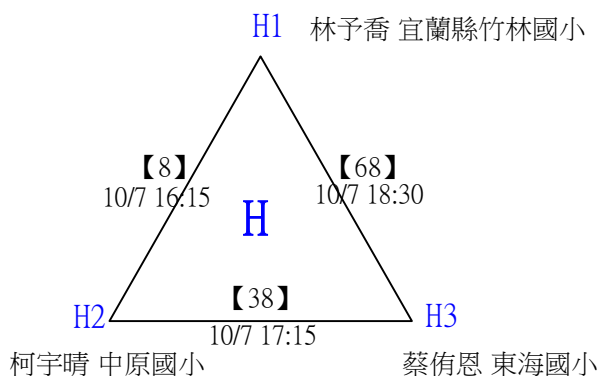
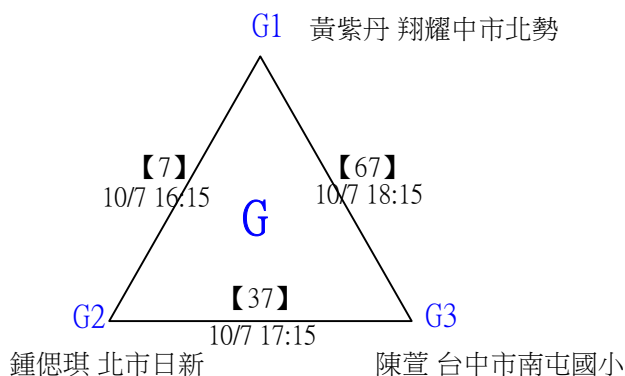
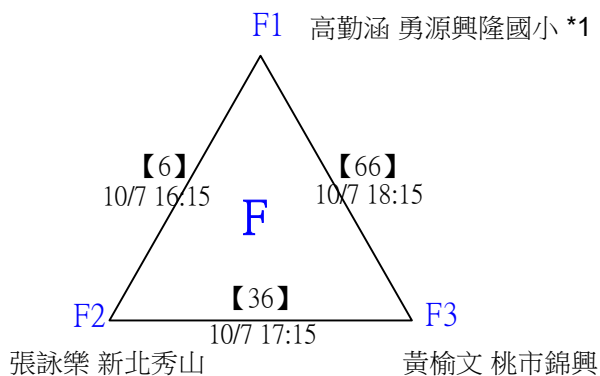
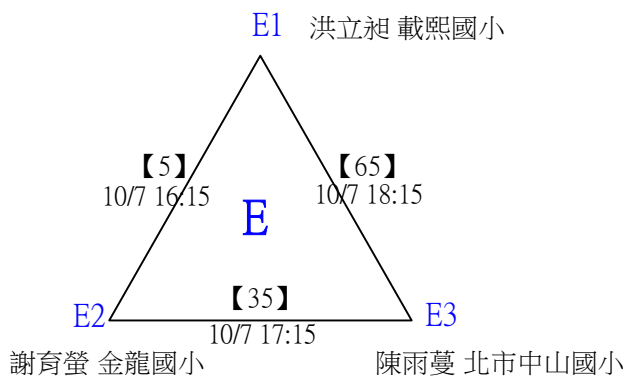
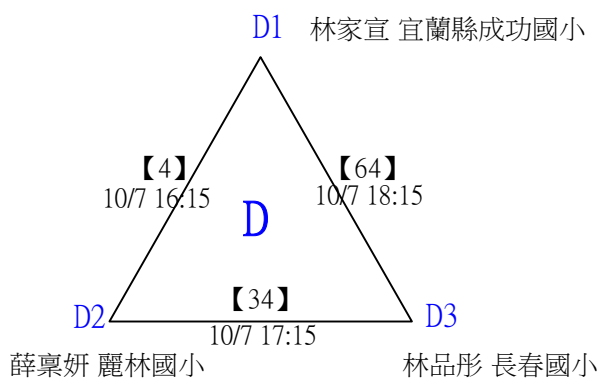
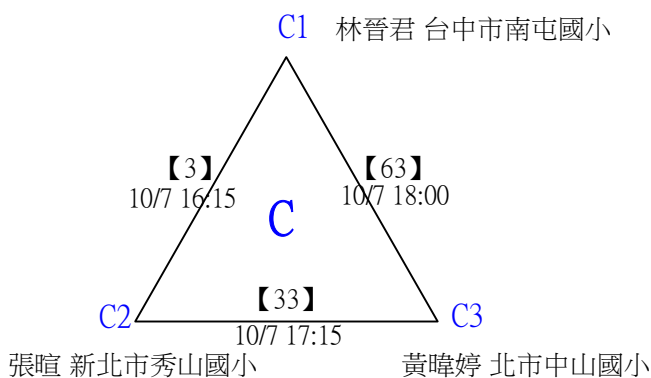
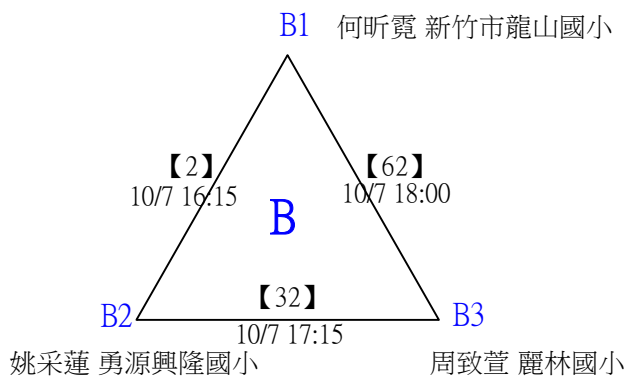
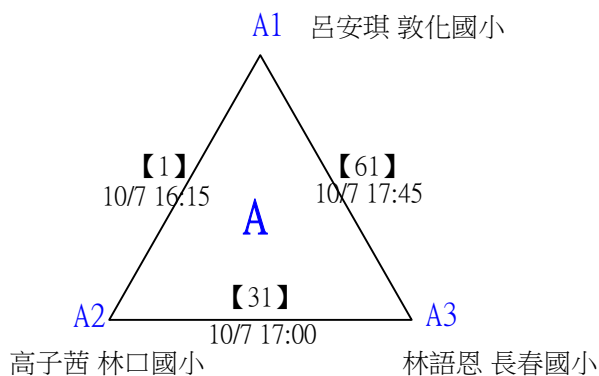

# 2023婕斯羽你同行國小暨親子分齡賽

取16名

國小五年級組女單 共90籤

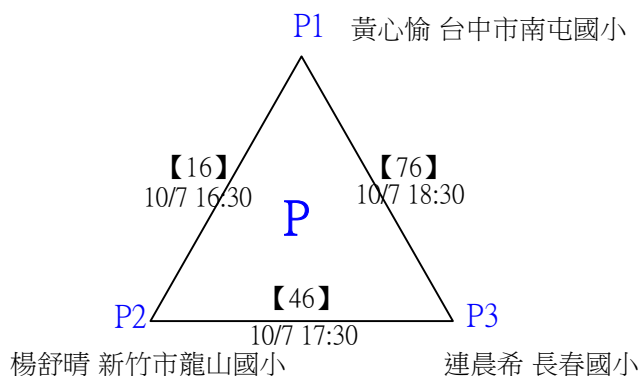
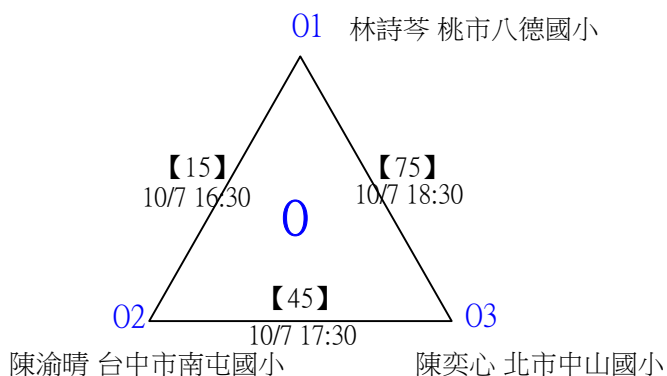
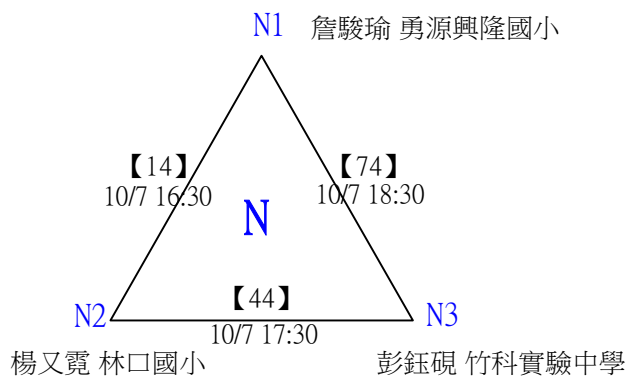
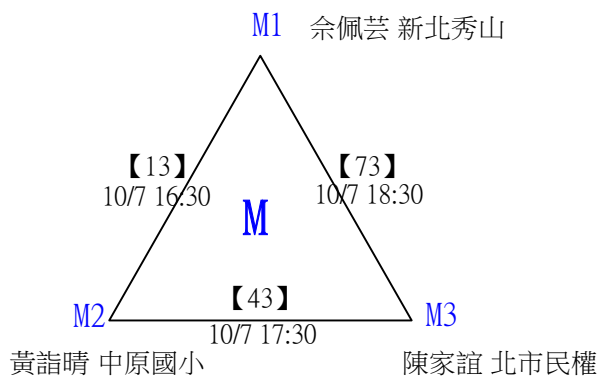
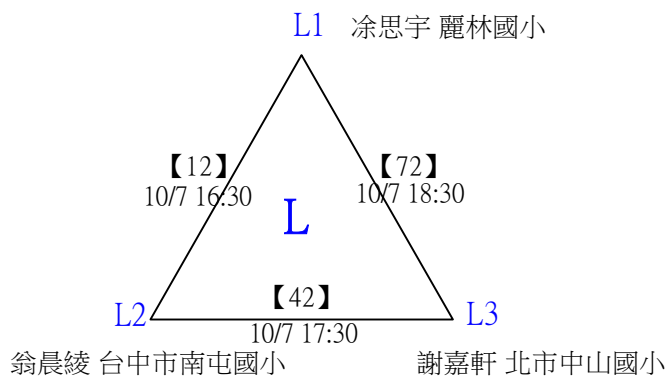
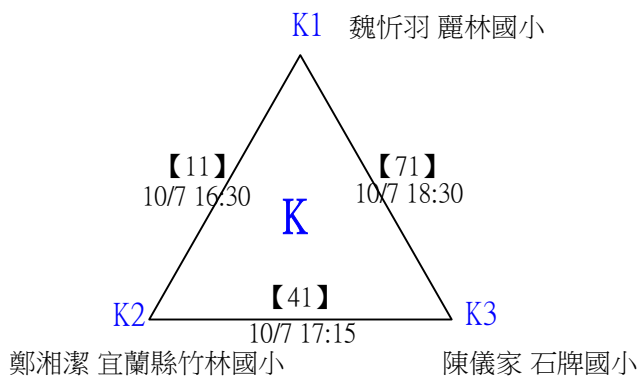
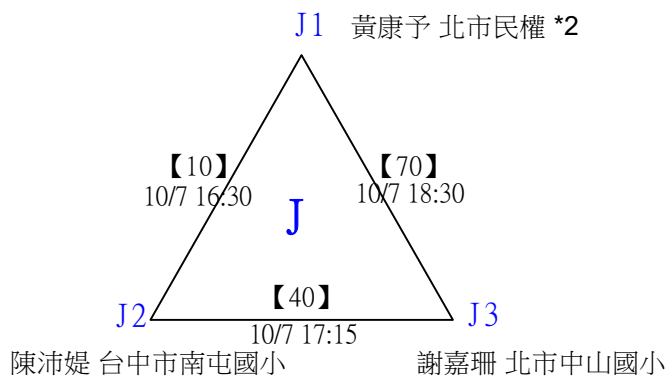
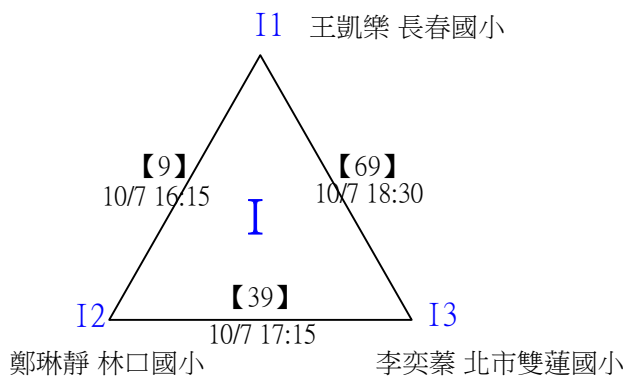

# 2023婕斯羽你同行國小暨親子分齡賽

取16名

國小五年級組女單 共90籤

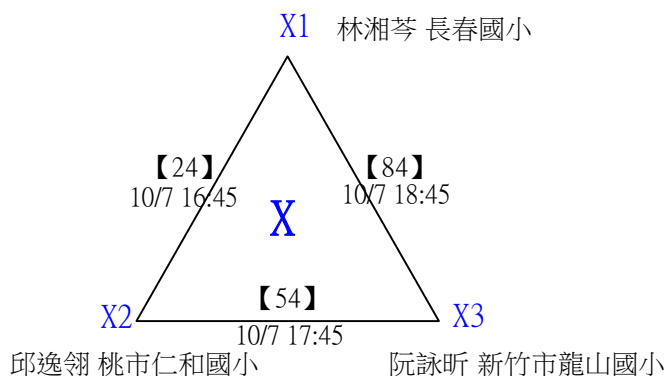
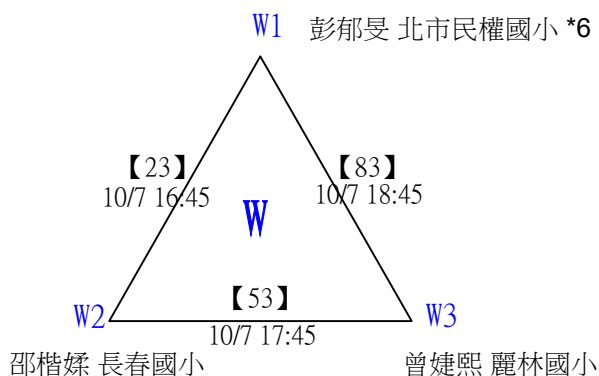
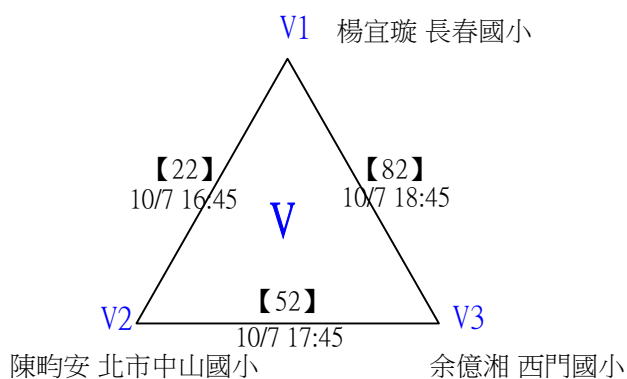
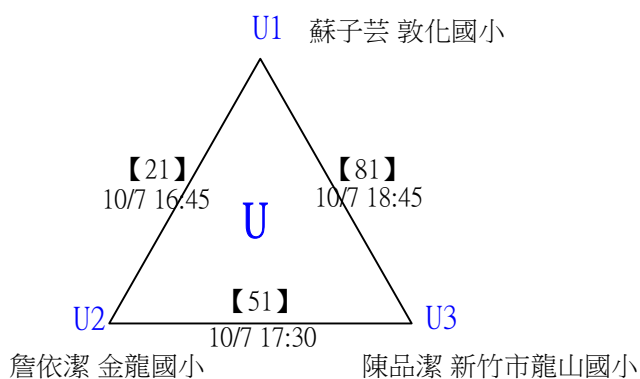
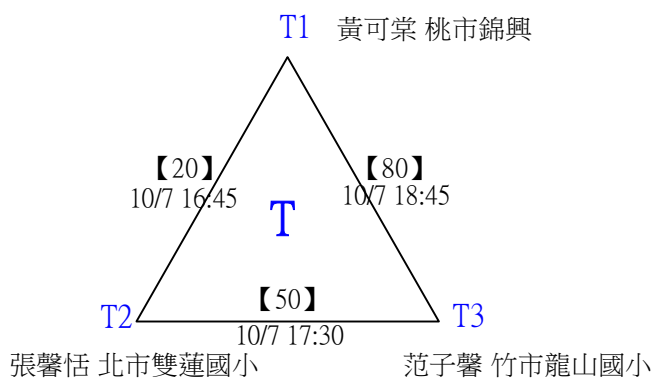
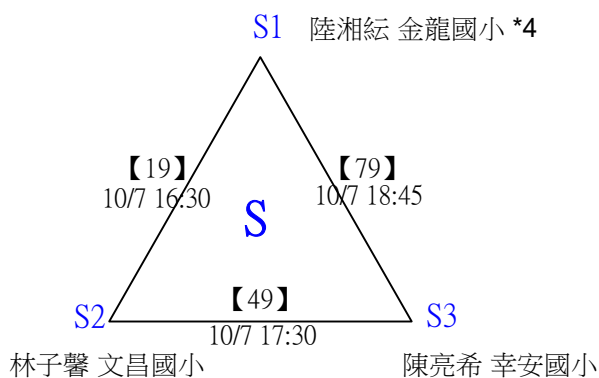
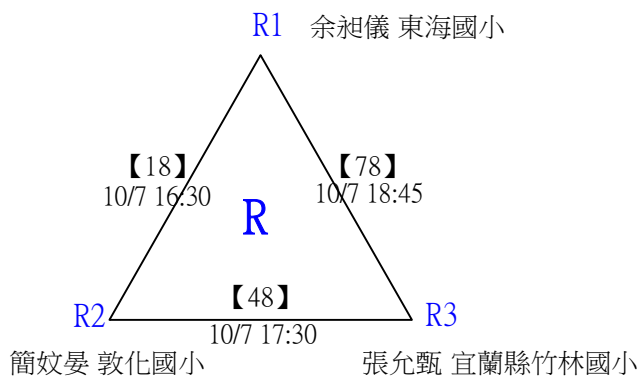
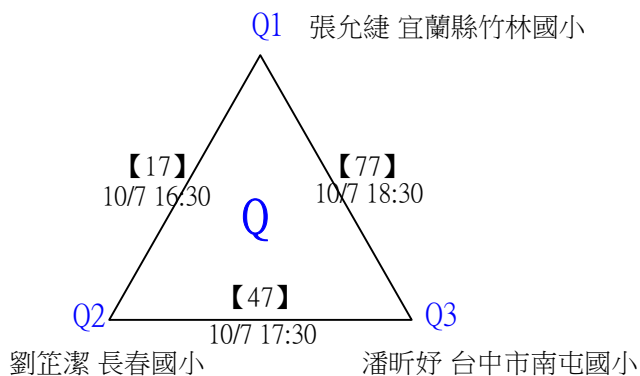

# 2023婕斯羽你同行國小暨親子分齡賽

取16名

國小五年級組女單 共90籤

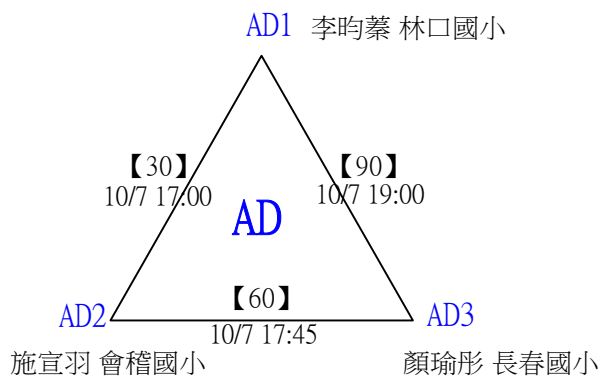
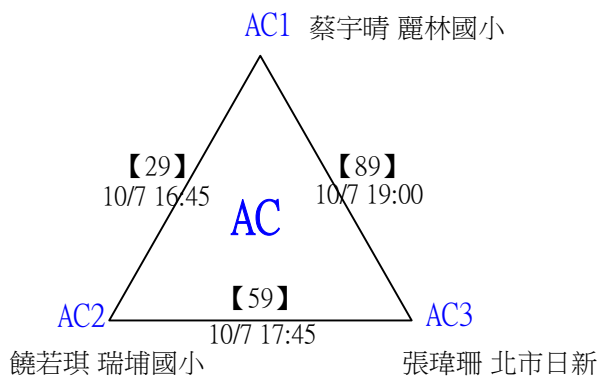
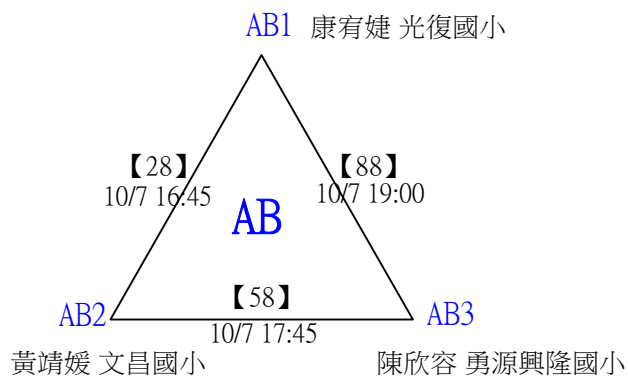
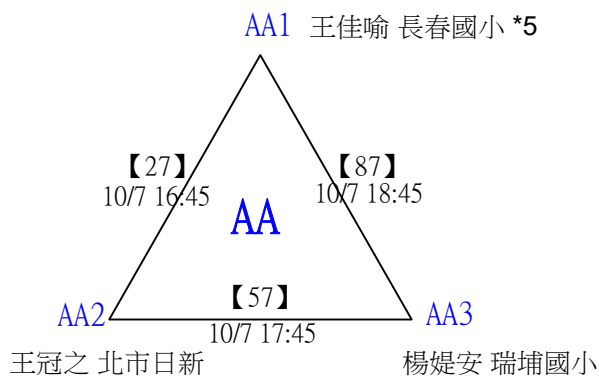
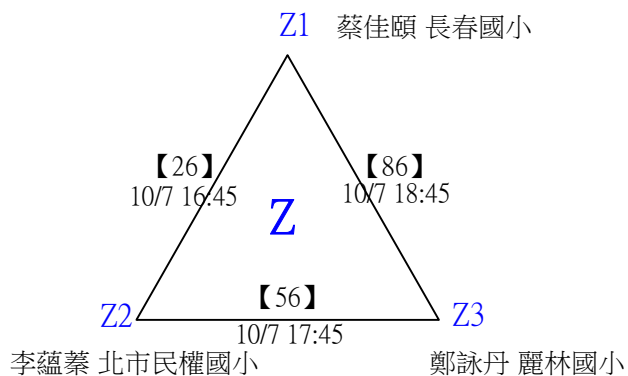
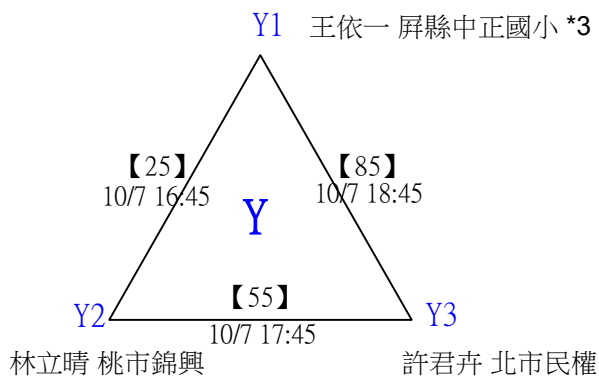



# 2023婕斯羽你同行國小暨親子分齡賽

取16名

國小五年級組女單

決賽：三角取一，抽籤決定位置。

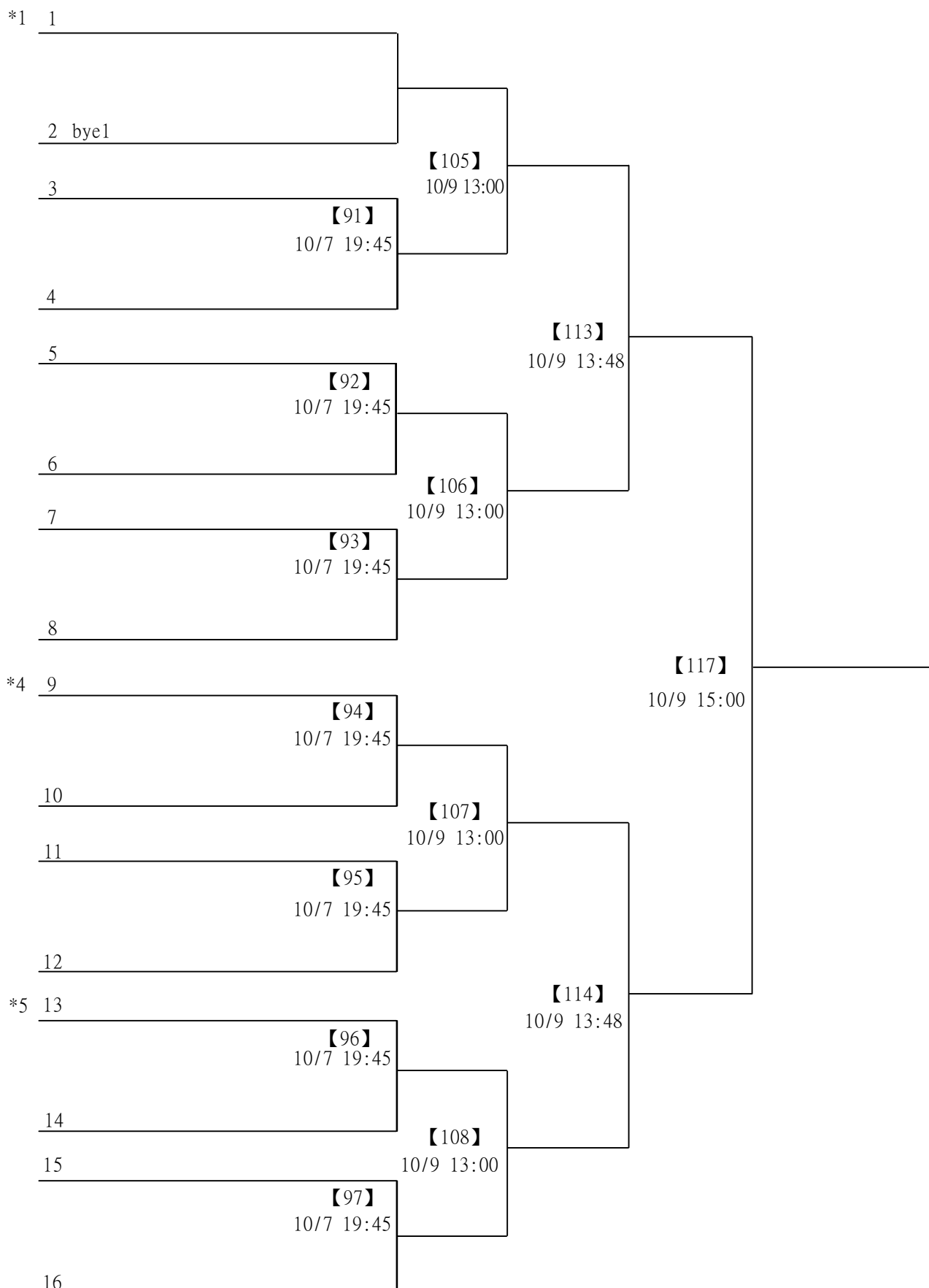

# 2023 婕斯羽你同行 國小暨親子分齡賽

取16名

國小五年級組女單

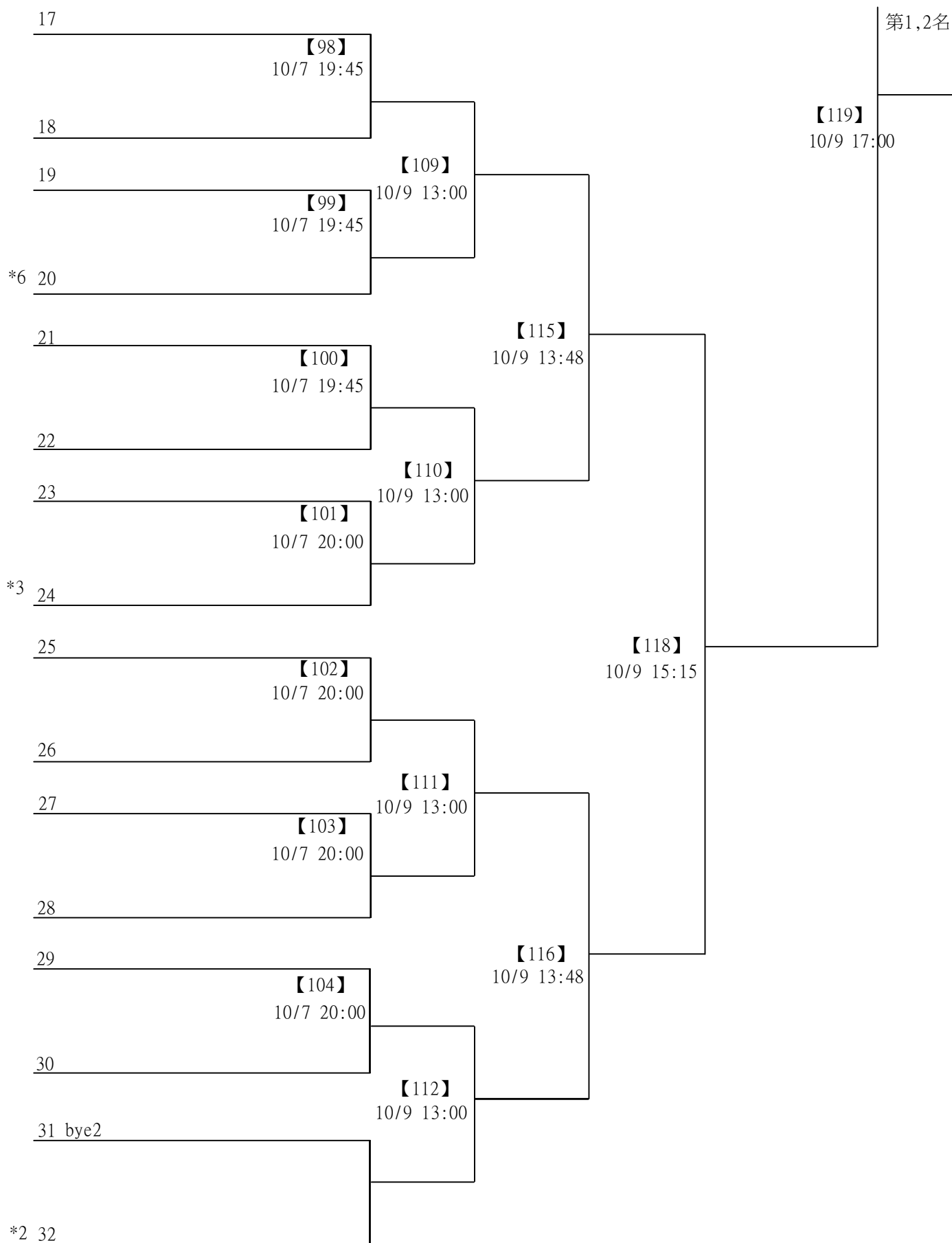

# 2023 婕斯羽你同行 國小暨親子分齡賽

取16名

國小五年級組男單 共171籤

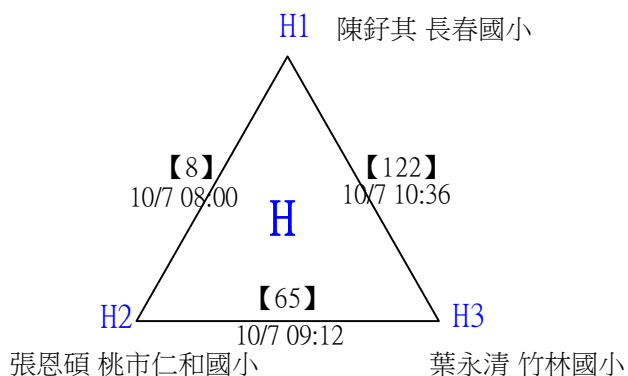
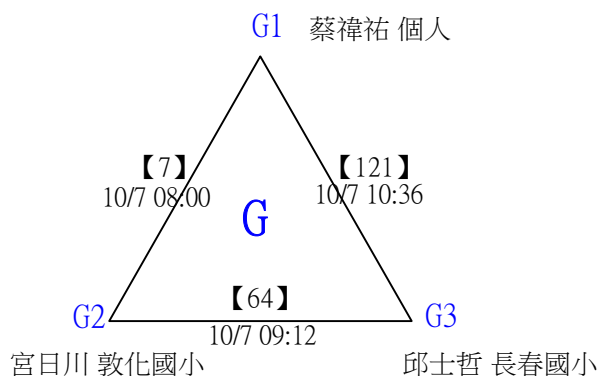
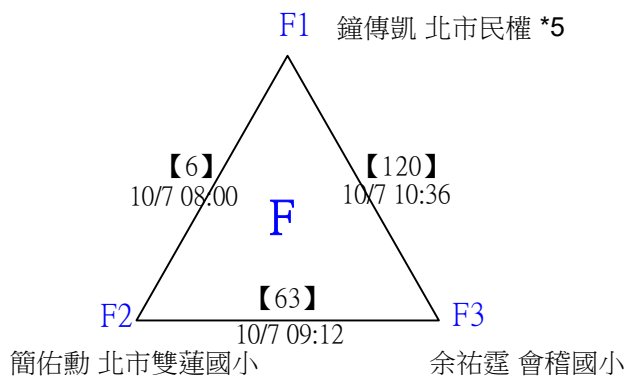
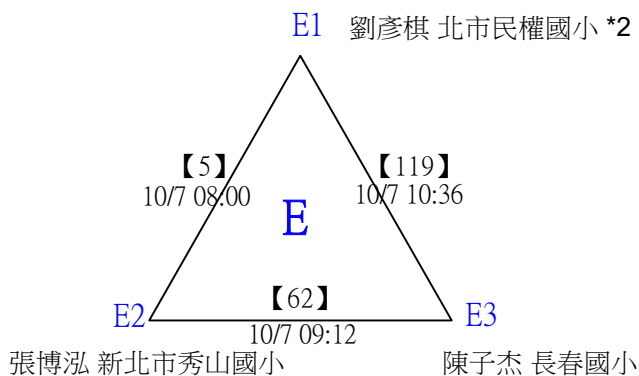
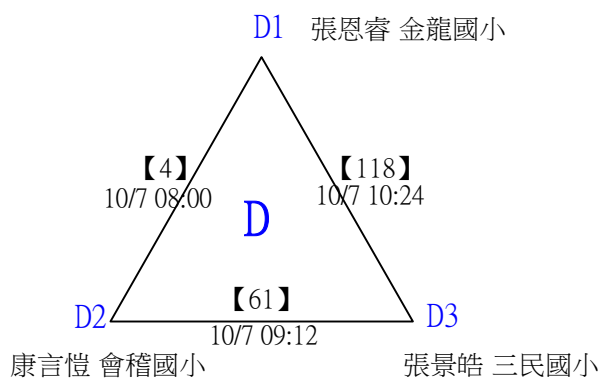
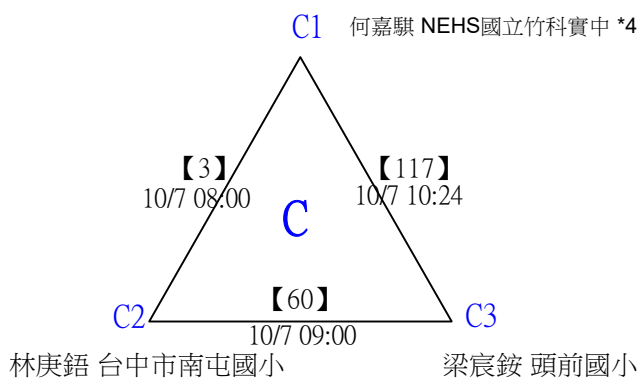
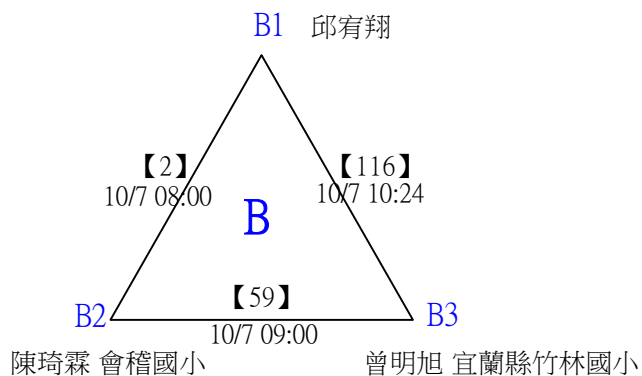
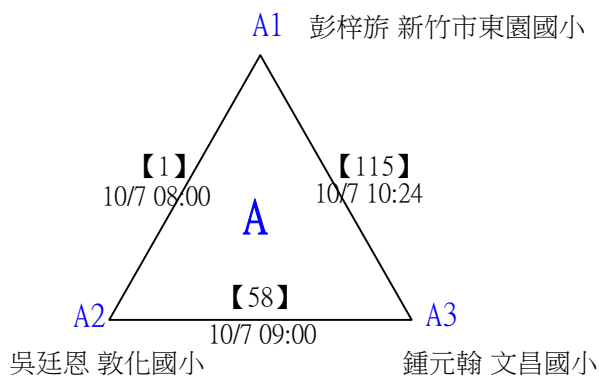

# 2023婕斯羽你同行國小暨親子分齡賽

取16名

國小五年級組男單 共171籤

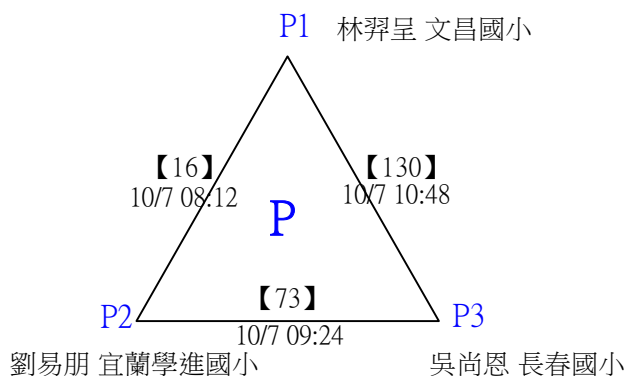
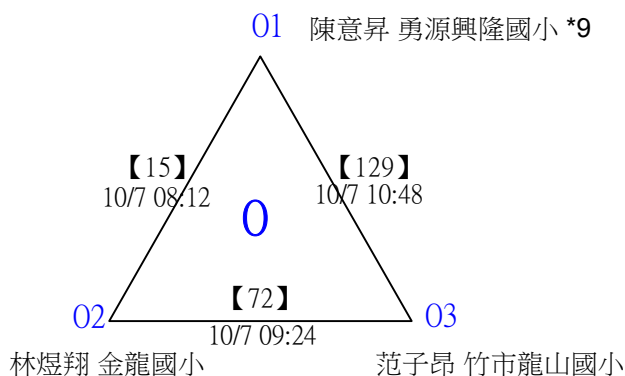
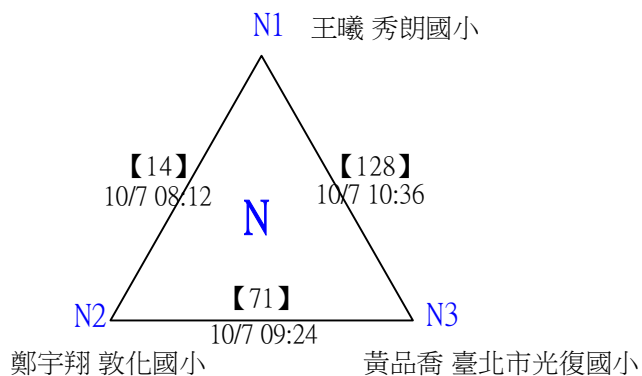
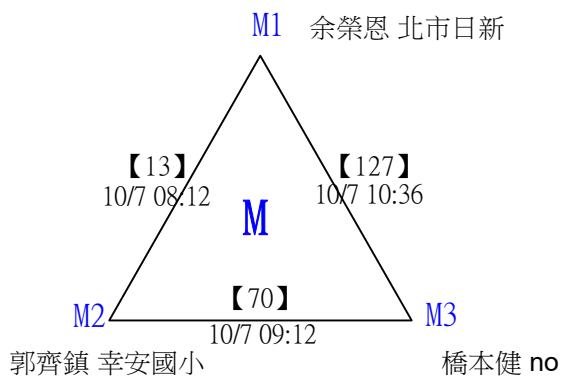
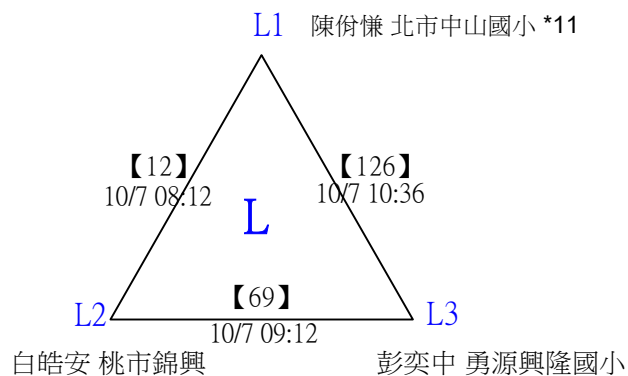
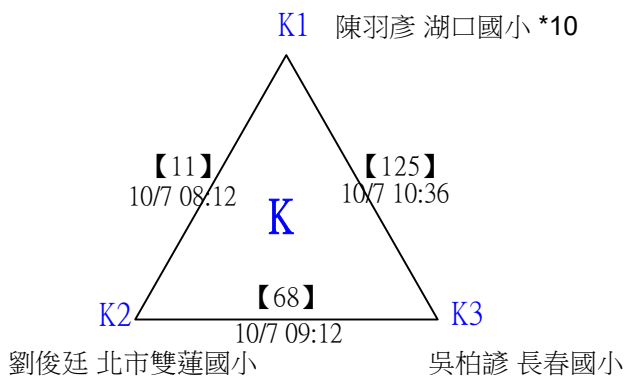
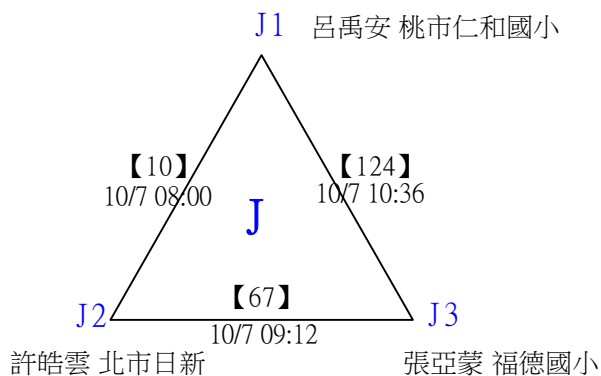
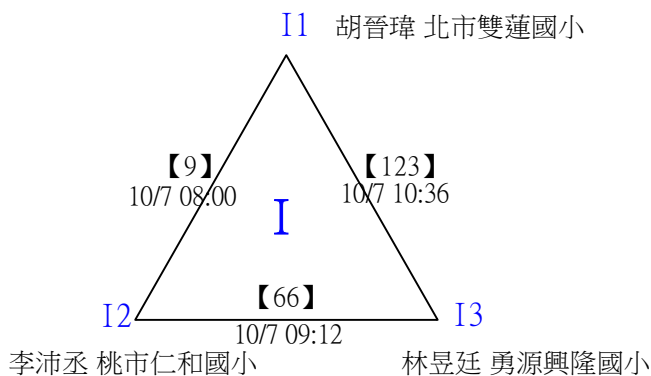

# 2023婕斯羽你同行國小暨親子分齡賽

取16名

國小五年級組男單 共171籤

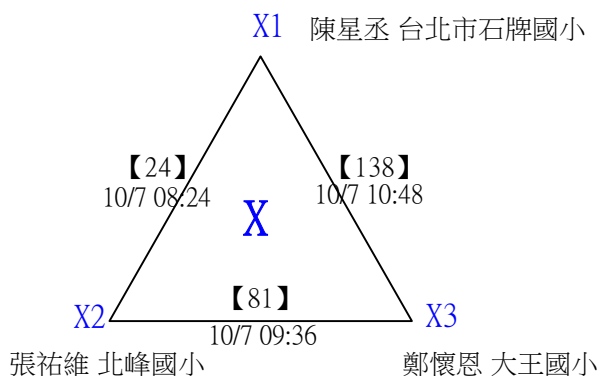
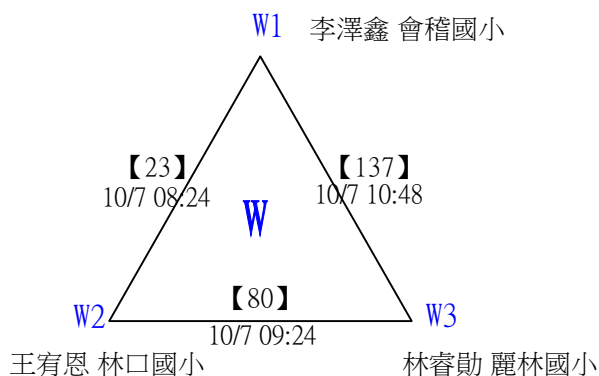
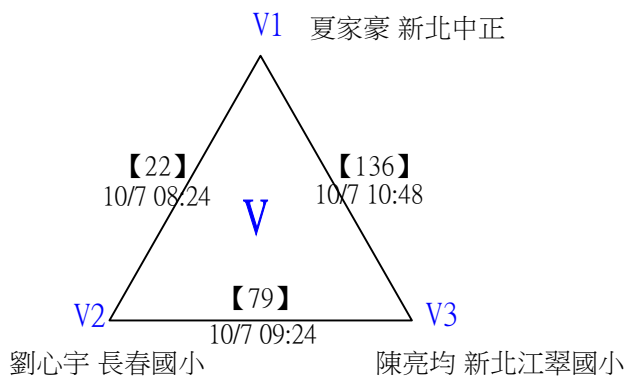
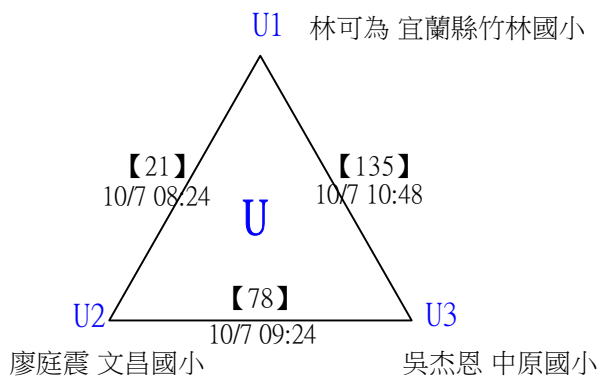
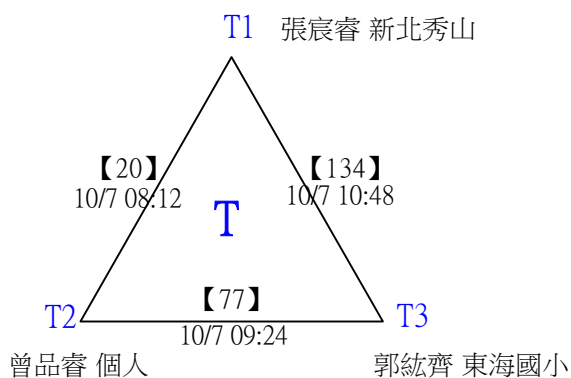
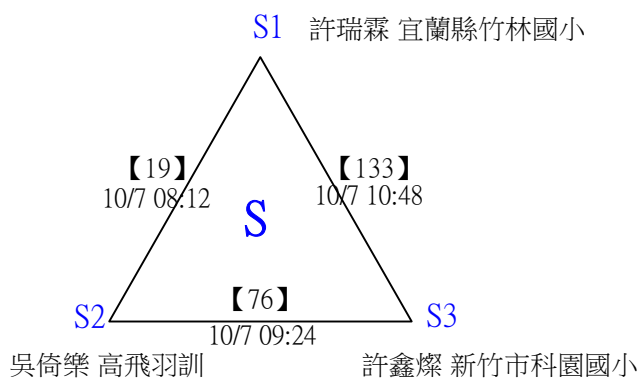
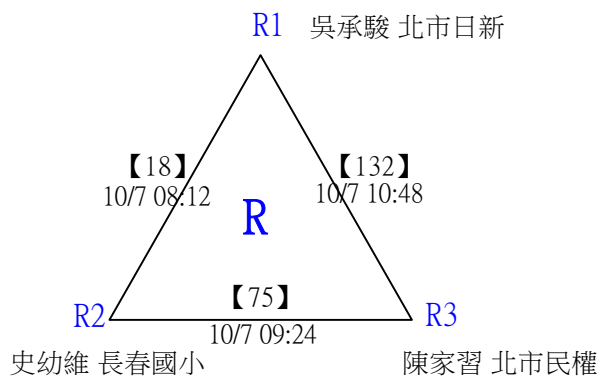
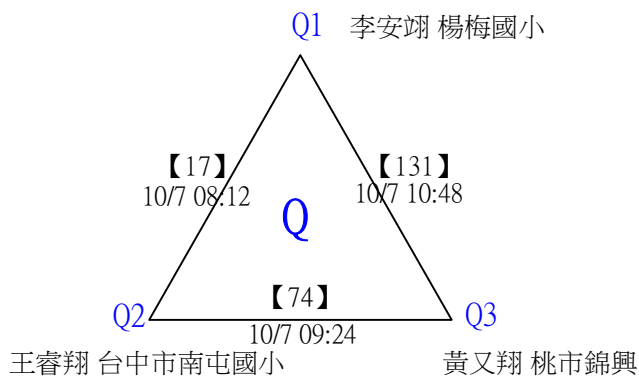

# 2023婕斯羽你同行國小暨親子分齡賽

取16名

國小五年級組男單 共171籤

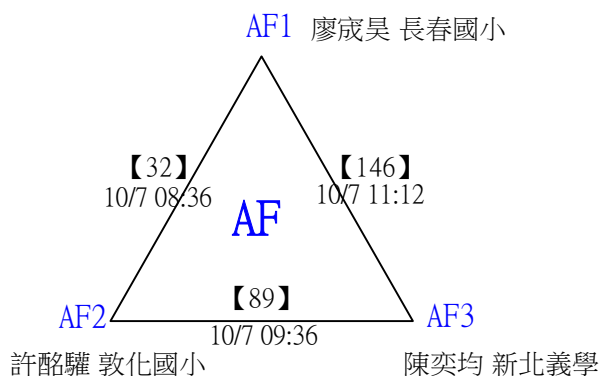
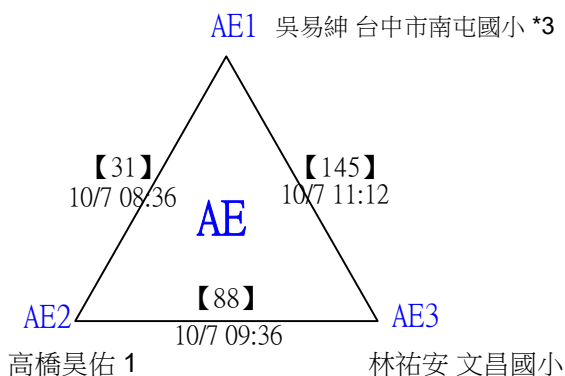
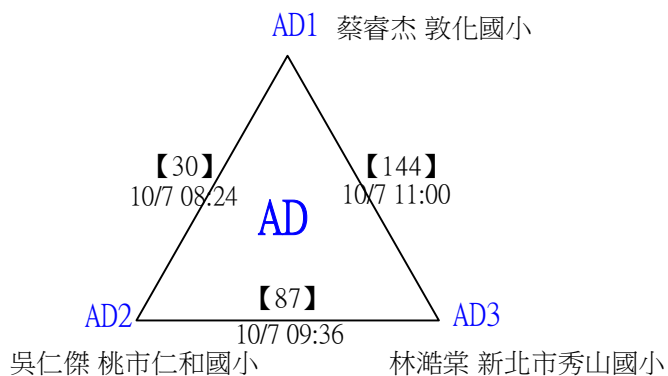
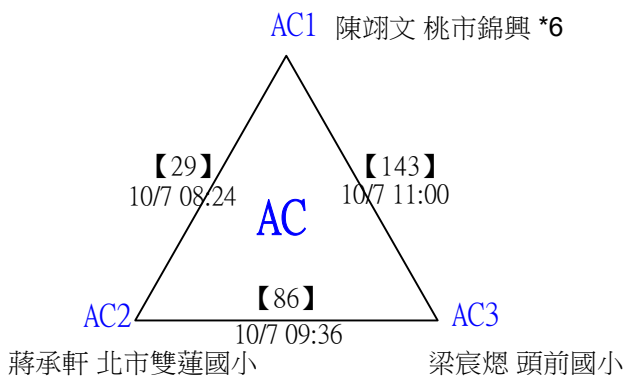
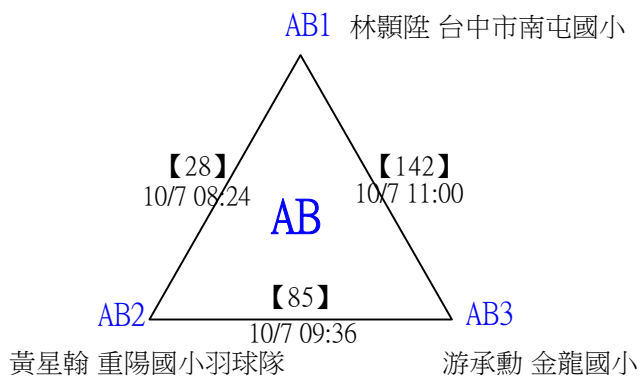
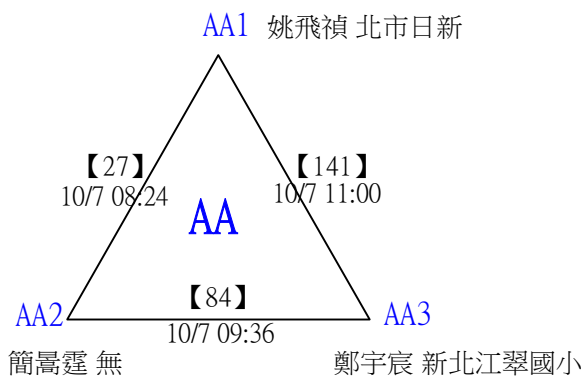
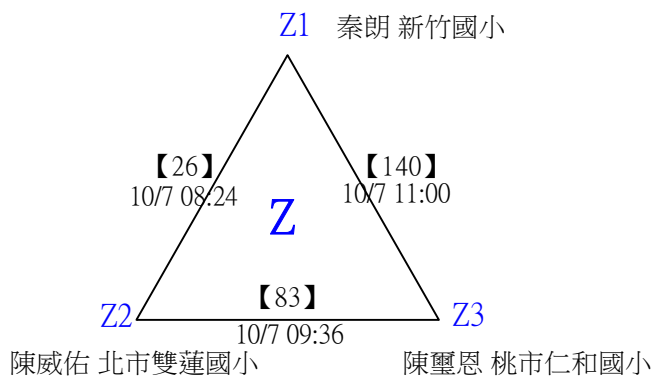
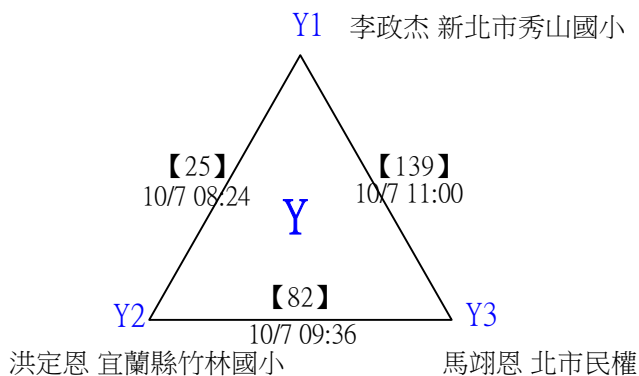

# 2023婕斯羽你同行國小暨親子分齡賽

取16名

國小五年級組男單 共171籤

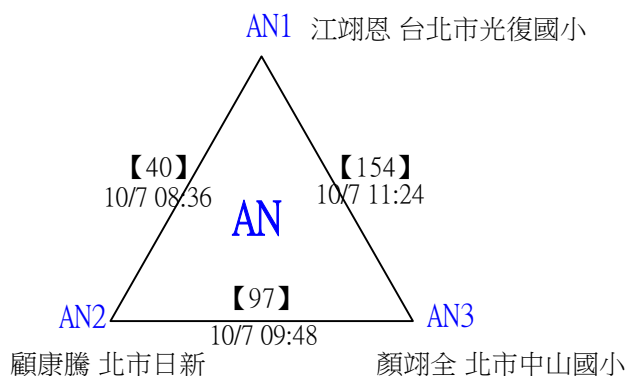
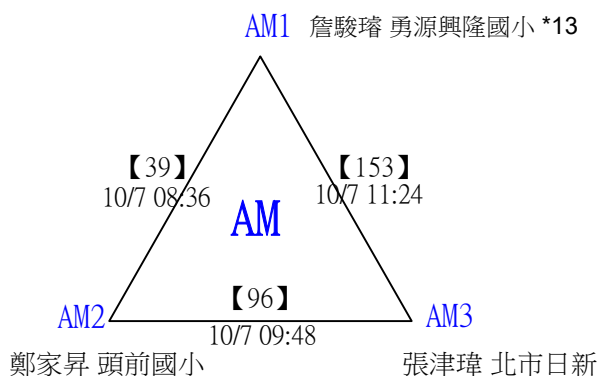
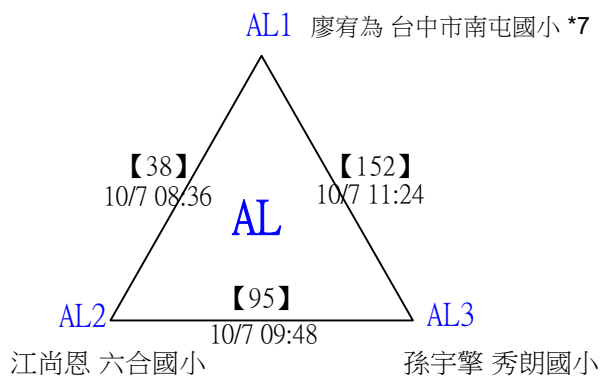
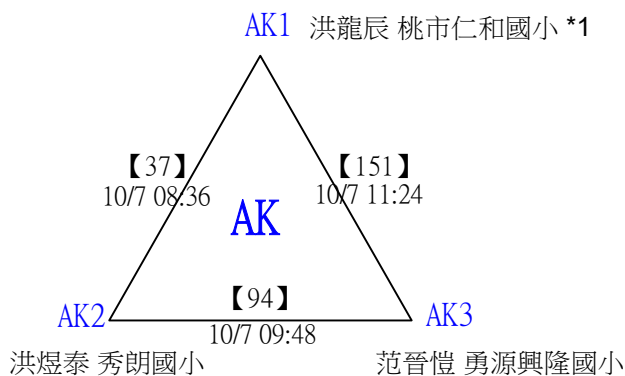
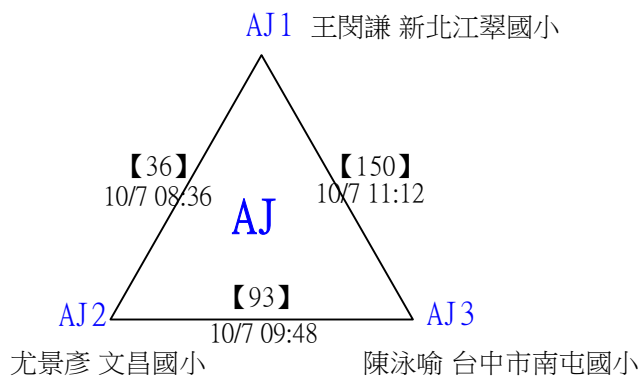
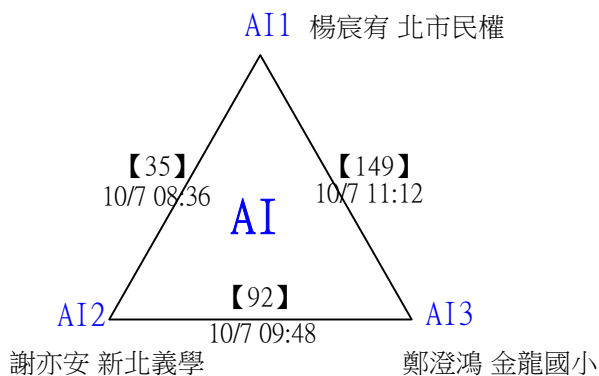
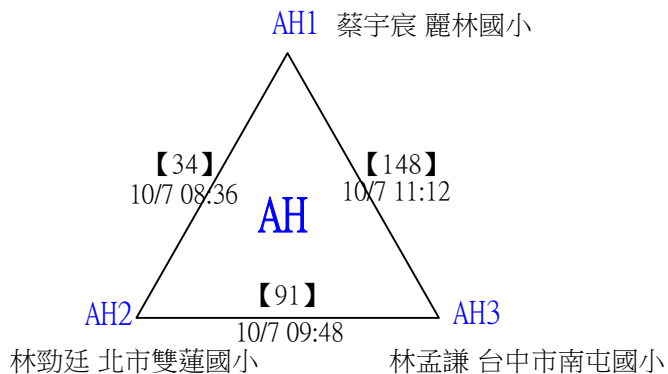
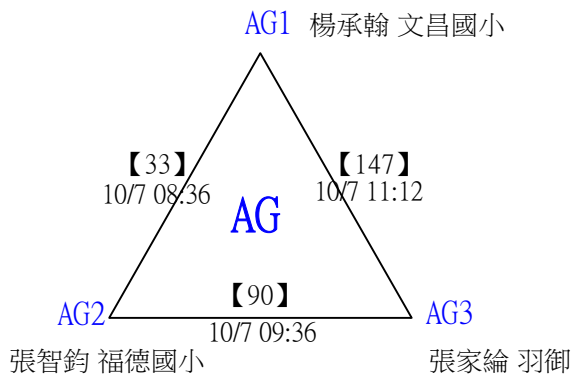

# 2023婕斯羽你同行國小暨親子分齡賽

取16名

國小五年級組男單 共171籤

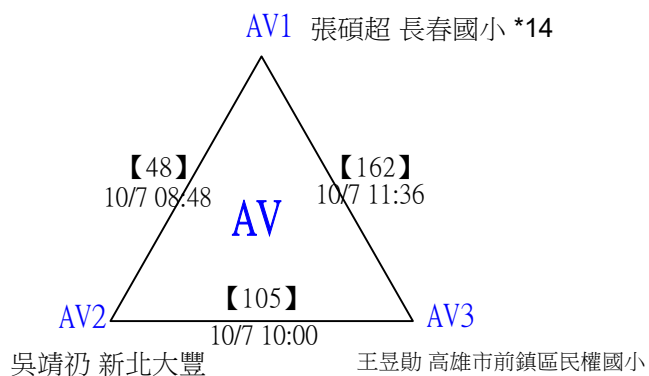
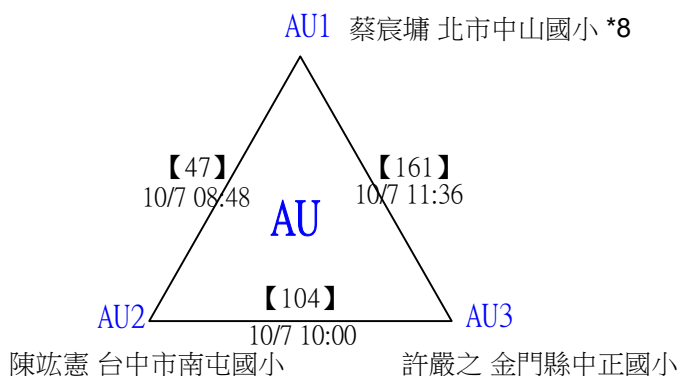
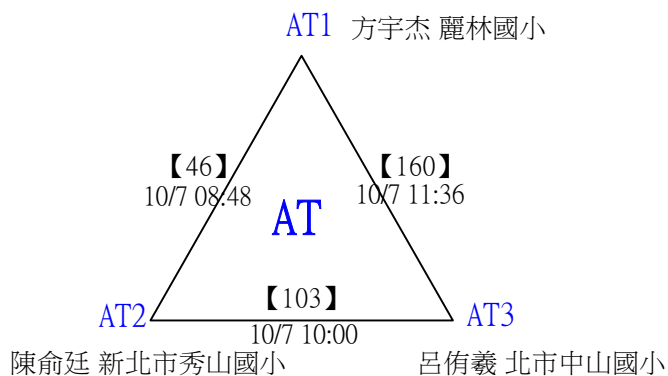
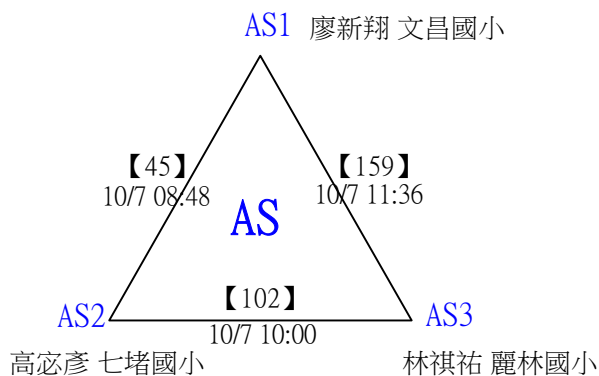
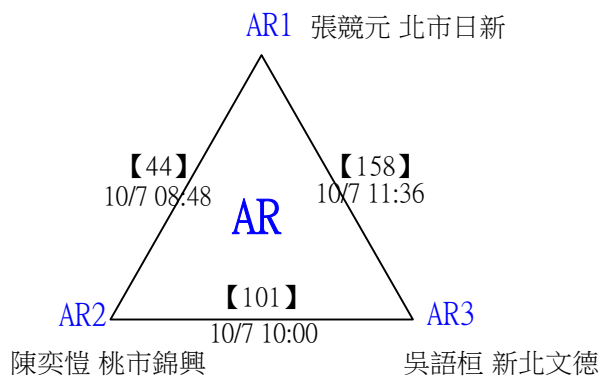
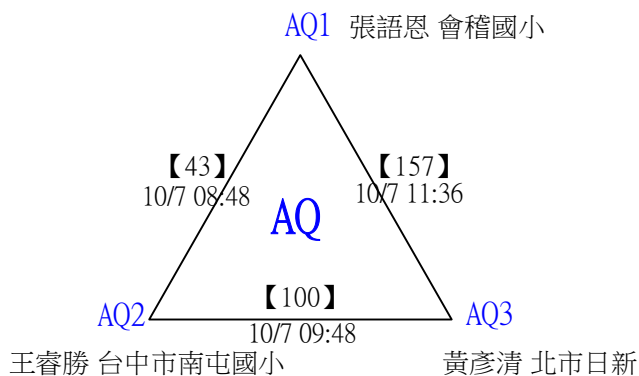
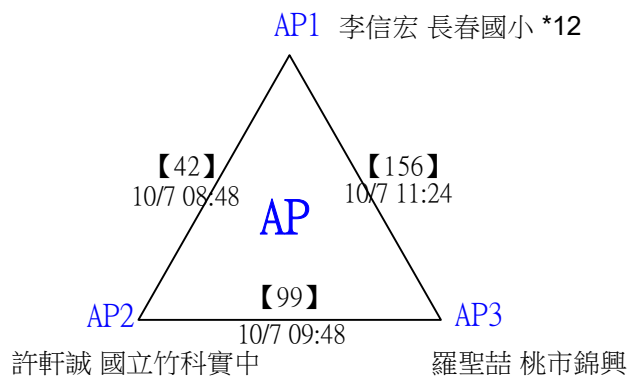
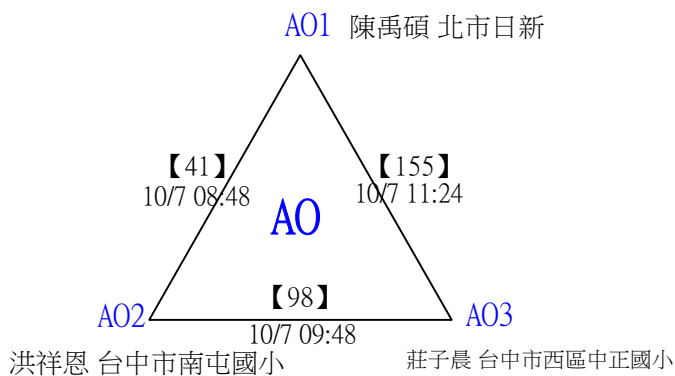



# 2023婕斯羽你同行國小暨親子分齡賽

取16名

國小五年級組男單 共171籤

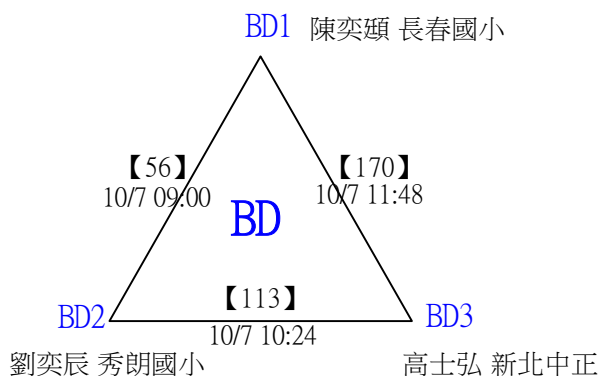
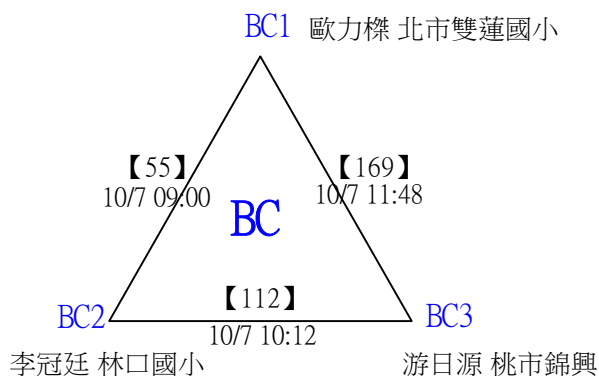
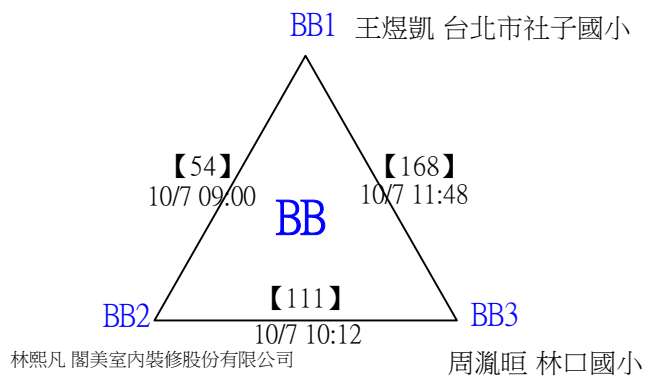
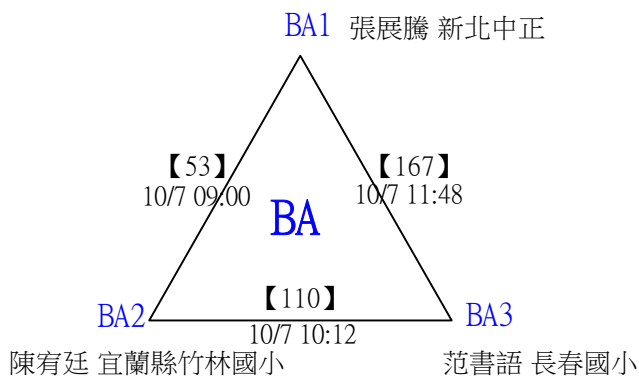
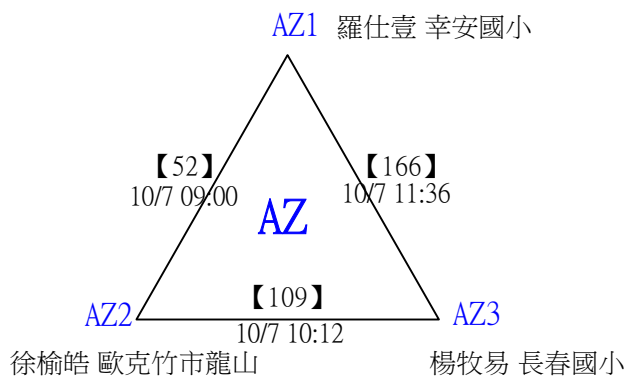
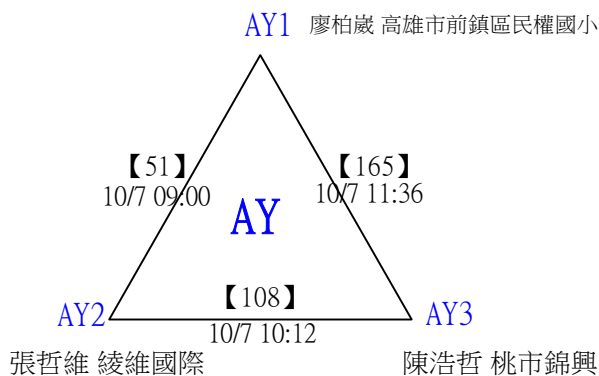
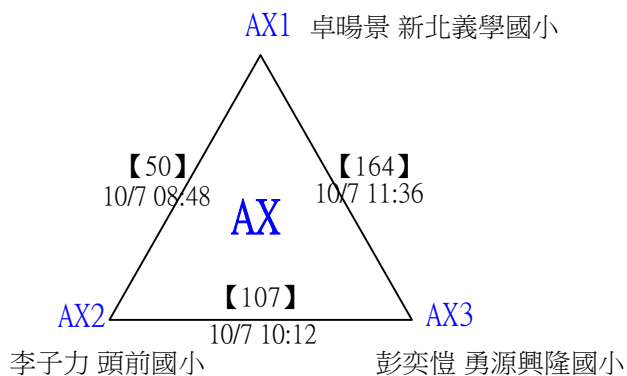
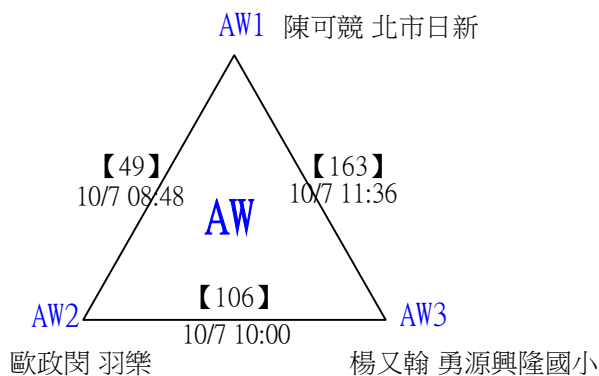

# 2023婕斯羽你同行國小暨親子分齡賽

國小五年級組男單 共171籤

取16名

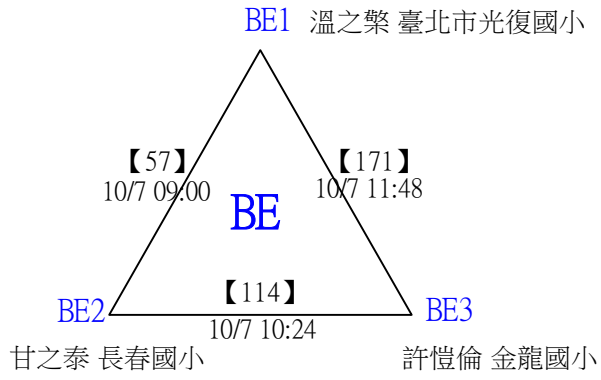

# 2023婕斯羽你同行國小暨親子分齡賽

取16名

國小五年級組男單

決賽：三角取一，抽籤決定位置。

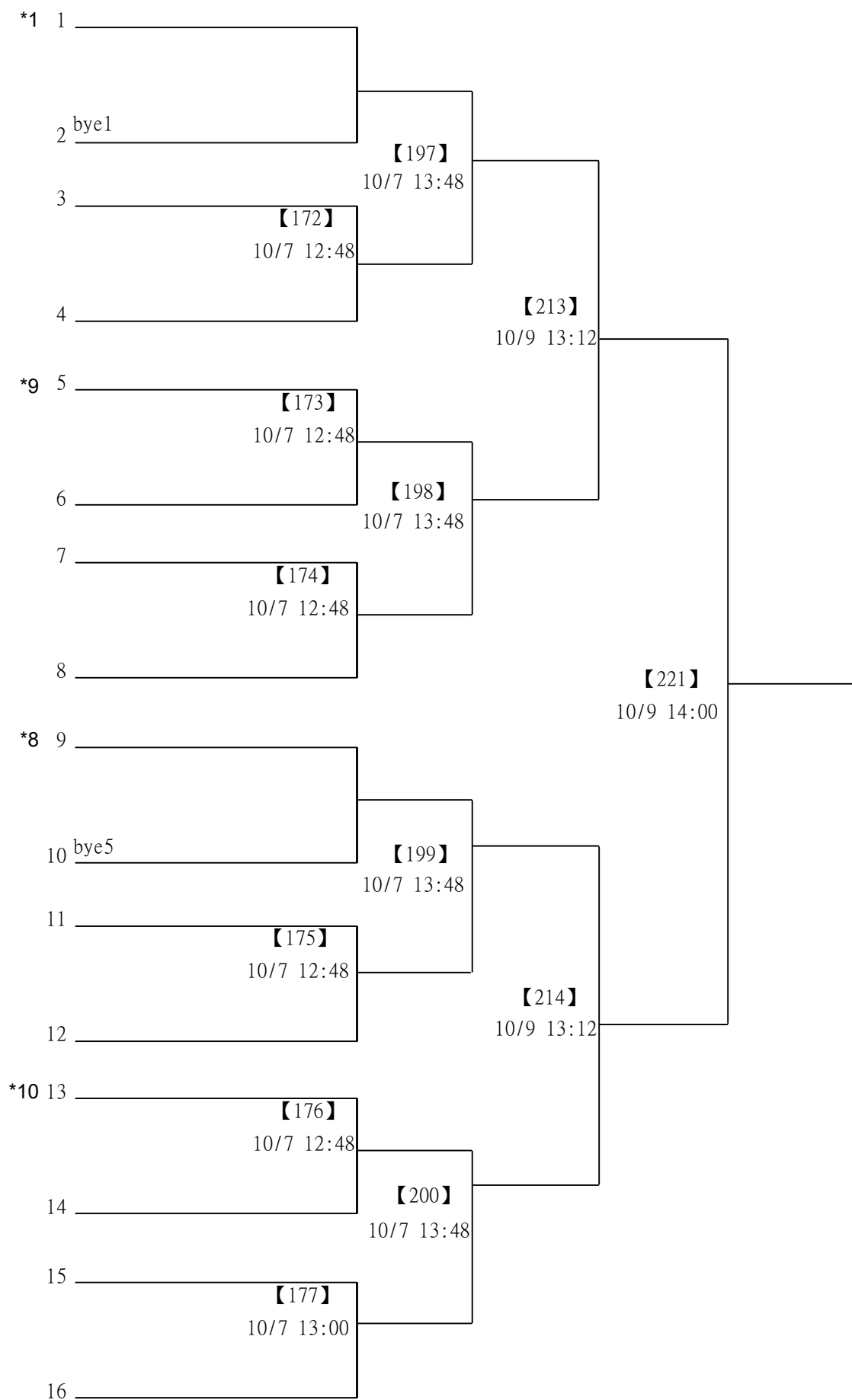

# 2023婕斯羽你同行國小暨親子分齡賽

取16名

國小五年級組男單

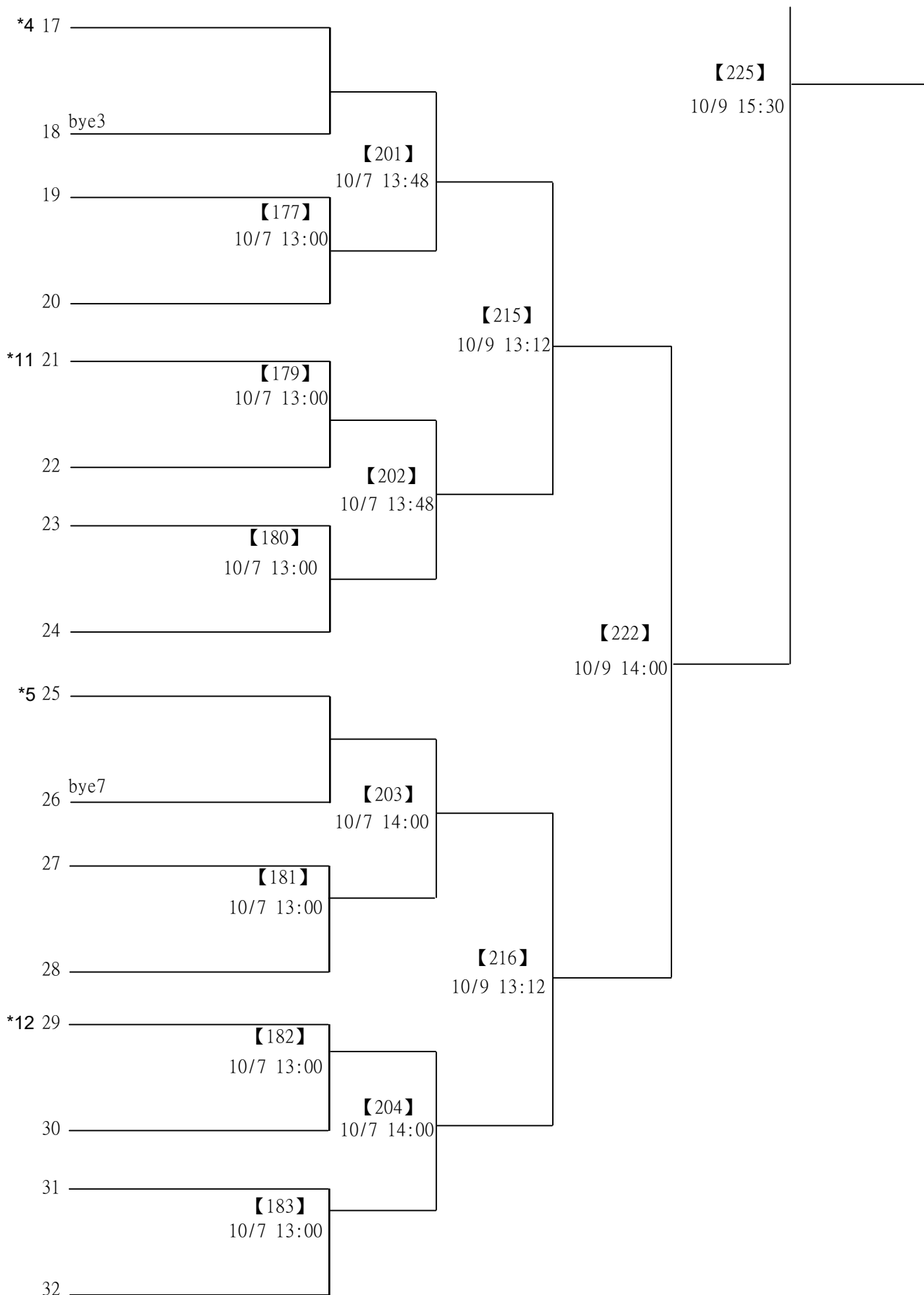

# 2023婕斯羽你同行國小暨親子分齡賽

取16名

國小五年級組男單

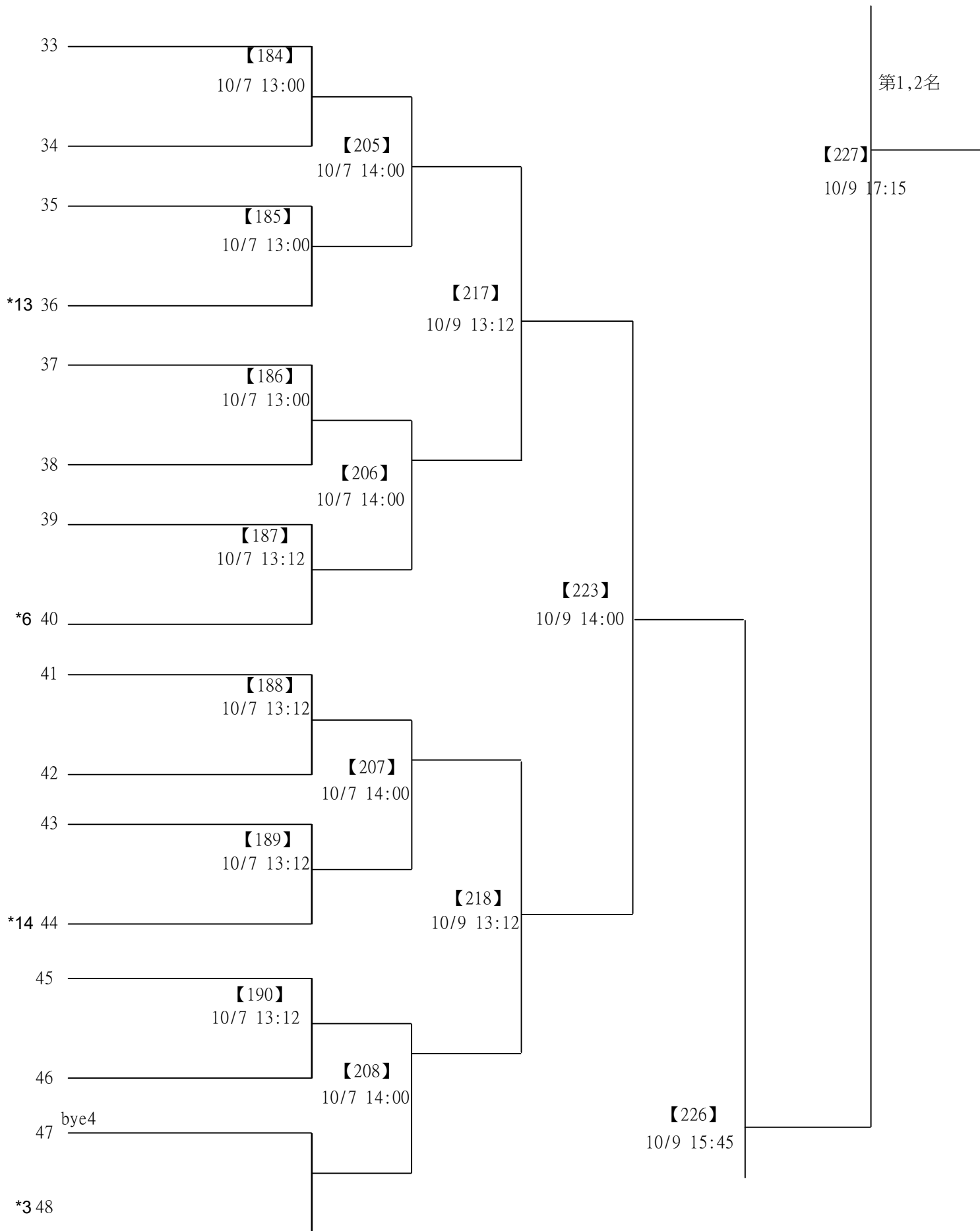

# 2023婕斯羽你同行國小暨親子分齡賽

取16名

國小五年級組男單

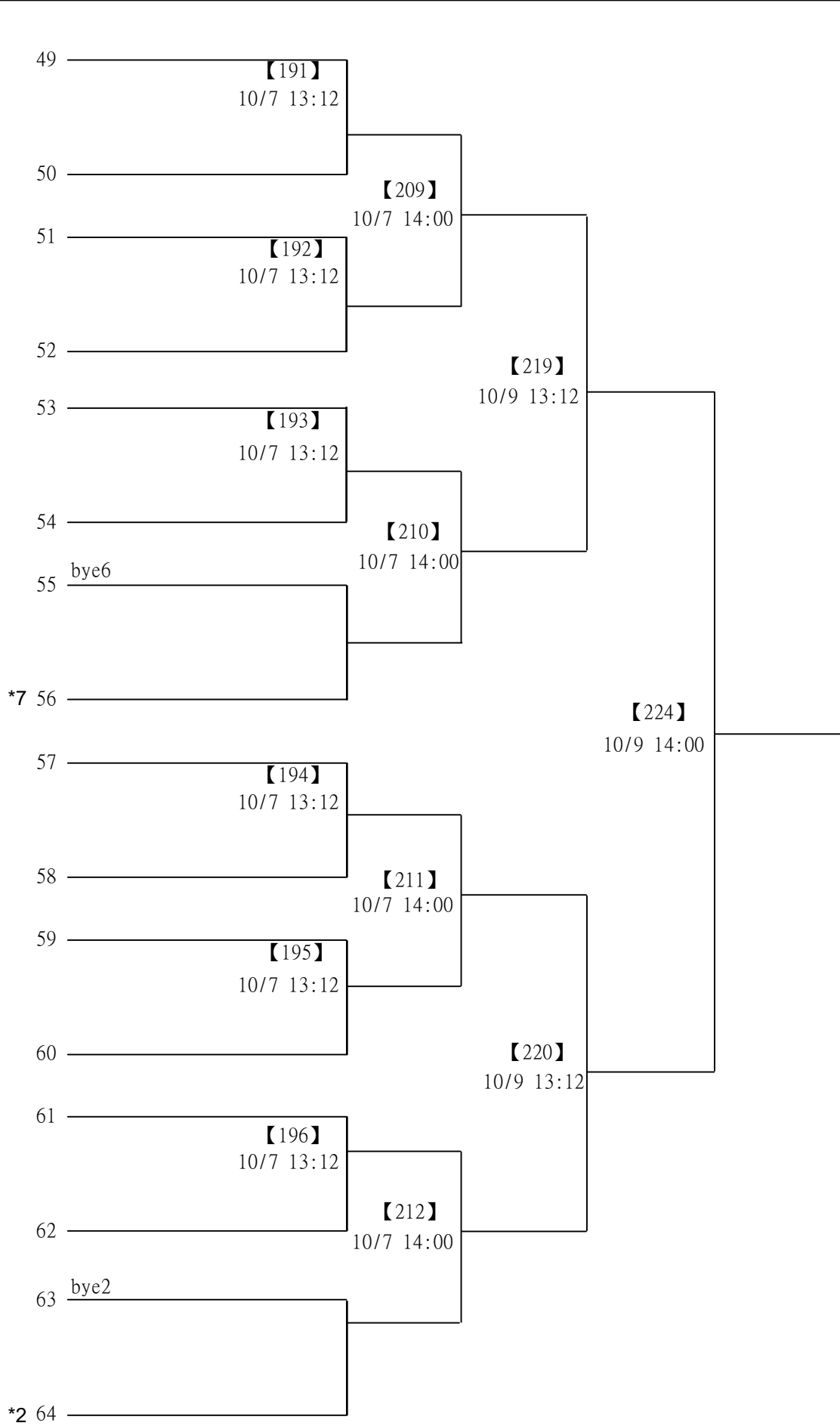

# 2023婕斯羽你同行國小暨親子分齡賽

取8名

國小六年級組女單 共85籤

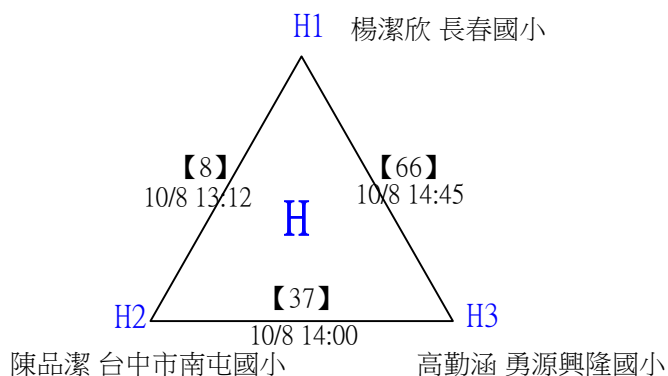
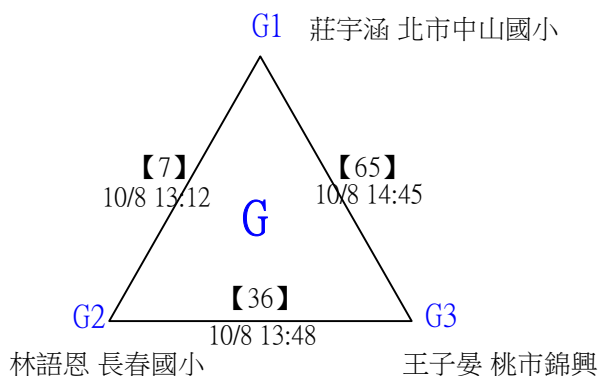
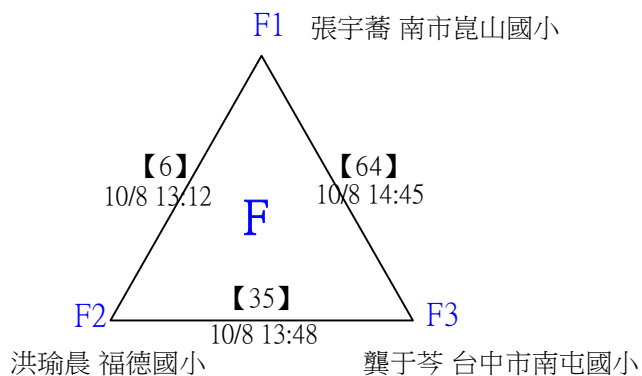
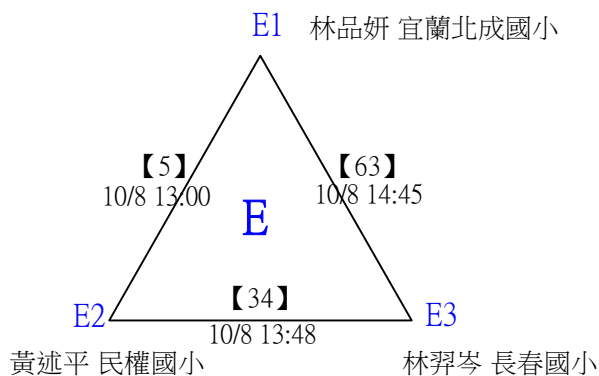
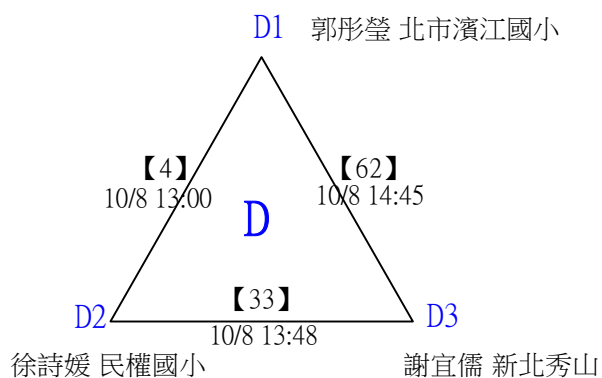
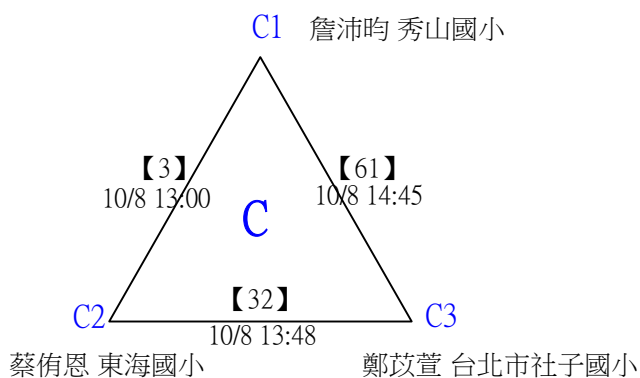
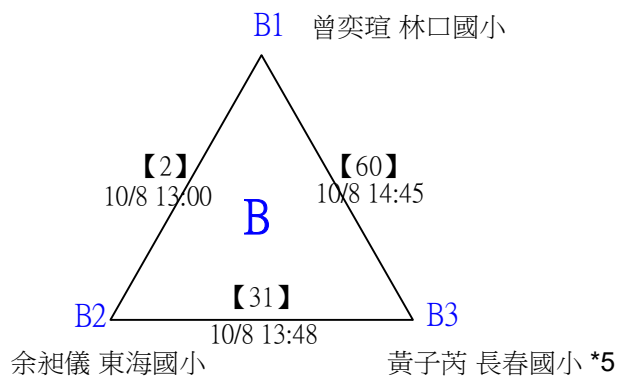
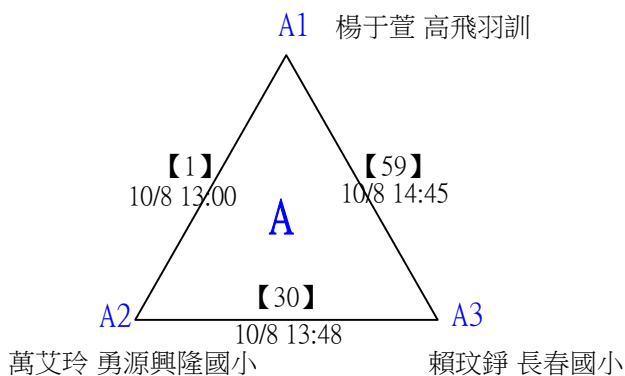

# 2023婕斯羽你同行國小暨親子分齡賽

取8名

國小六年級組女單 共85籤

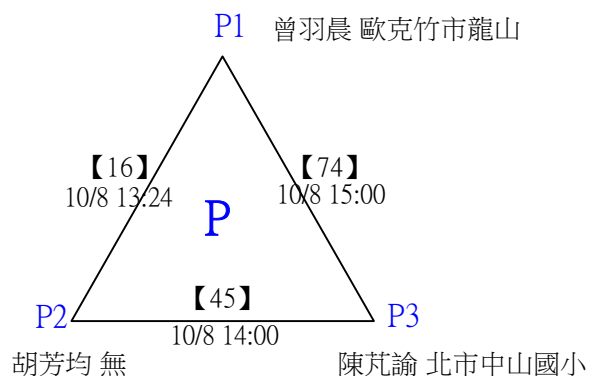
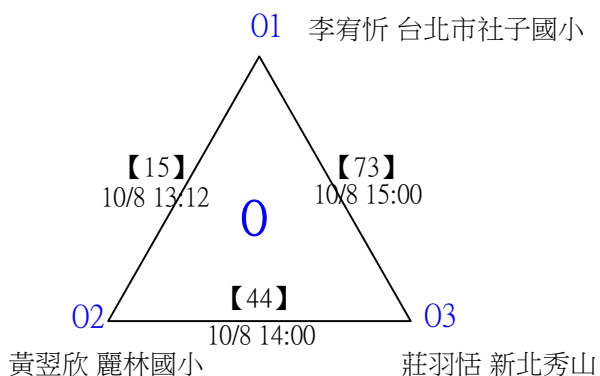
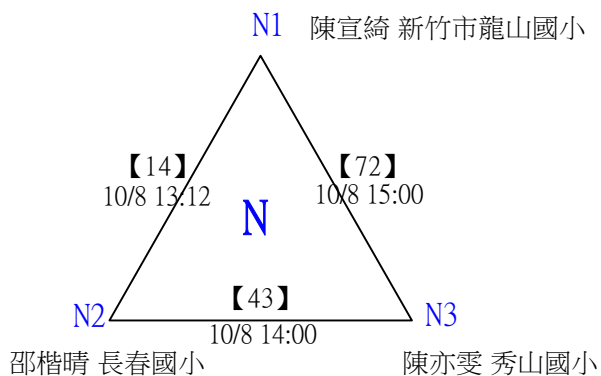
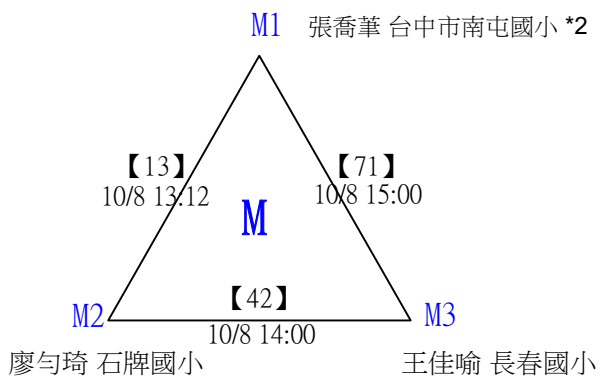
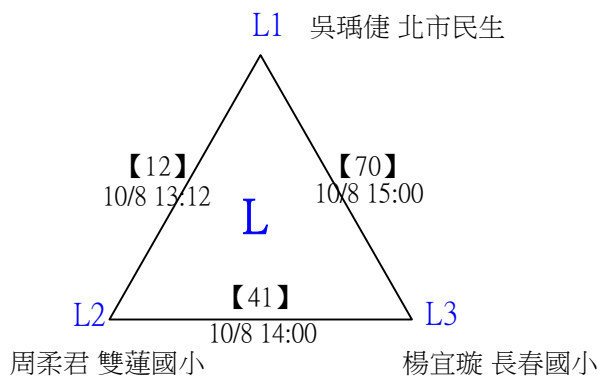
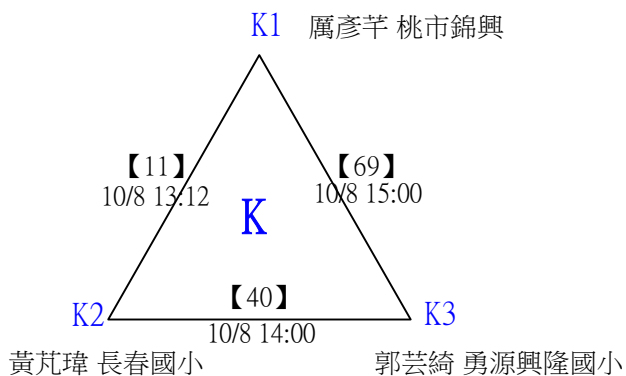
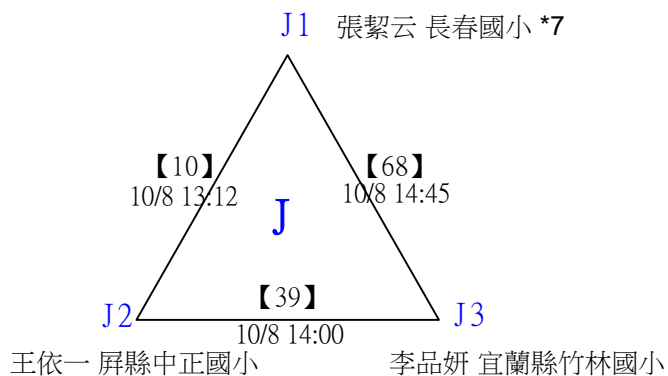
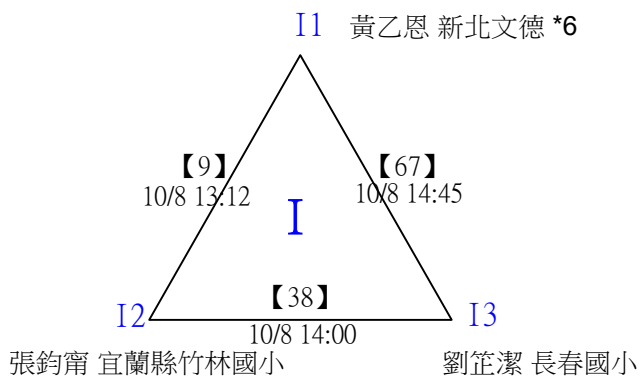



# 2023婕斯羽你同行國小暨親子分齡賽

取8名

國小六年級組女單 共85籤

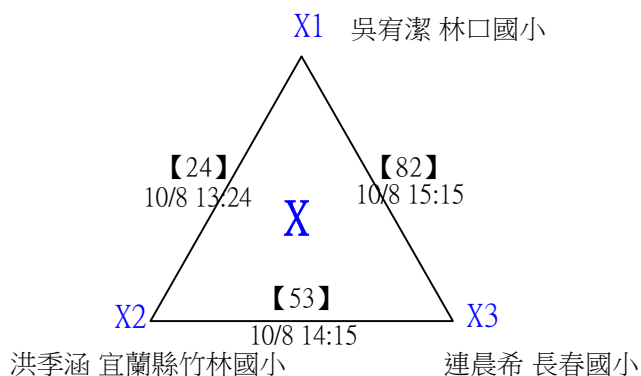
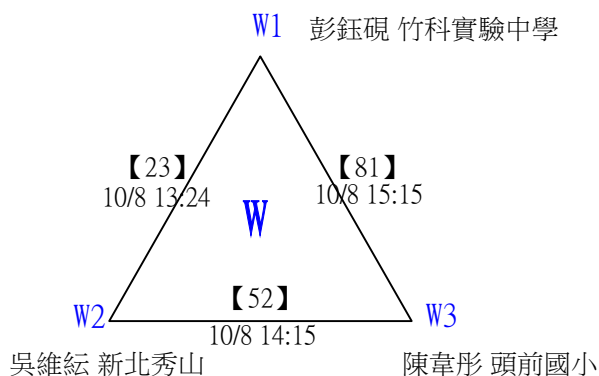
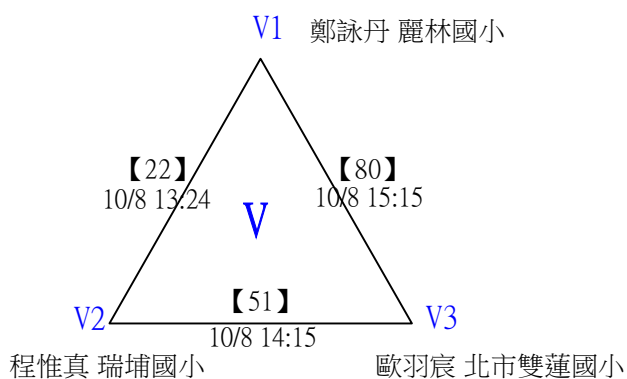
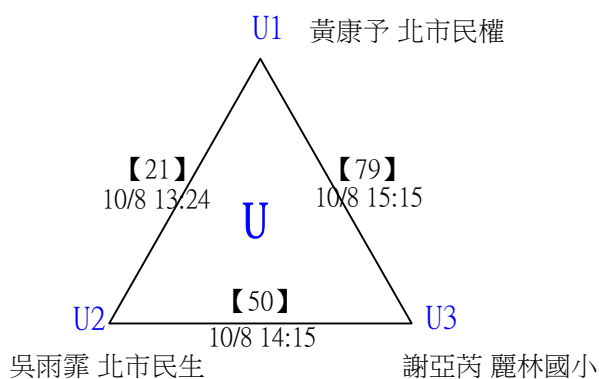
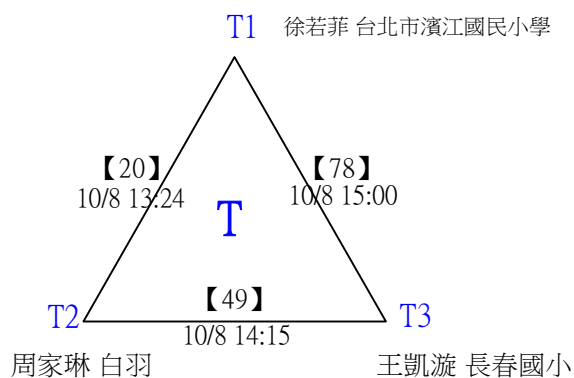
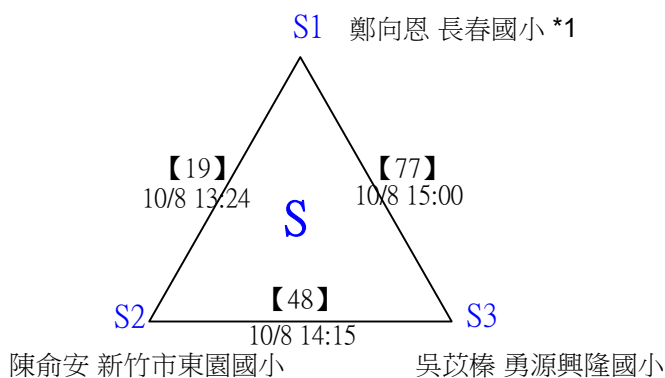
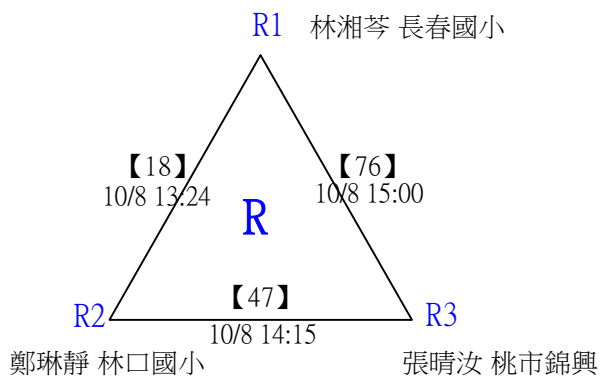
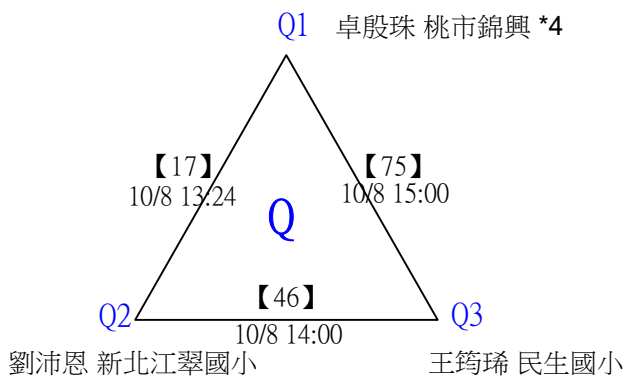

# 2023婕斯羽你同行國小暨親子分齡賽

取8名

國小六年級組女單 共85籤

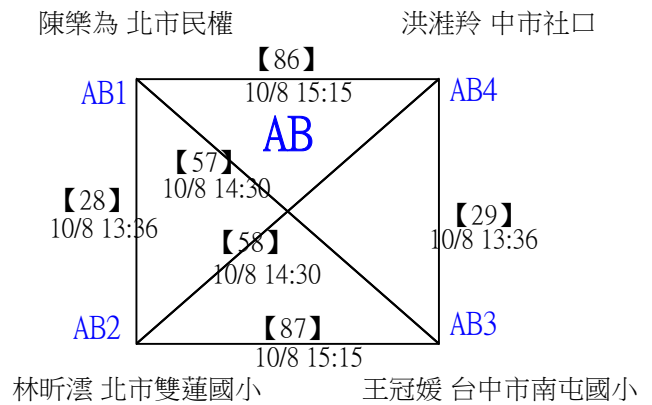
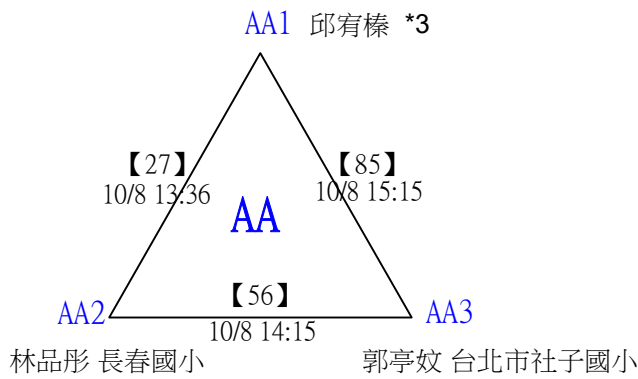
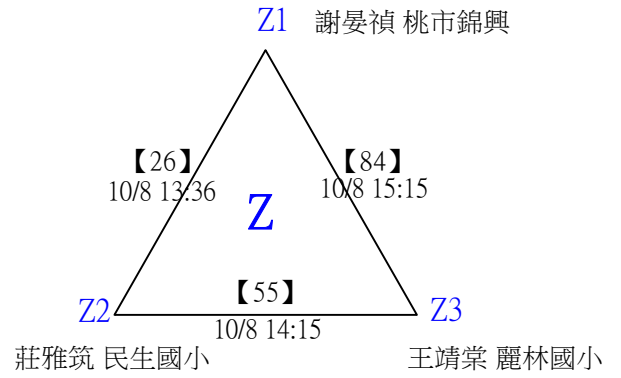
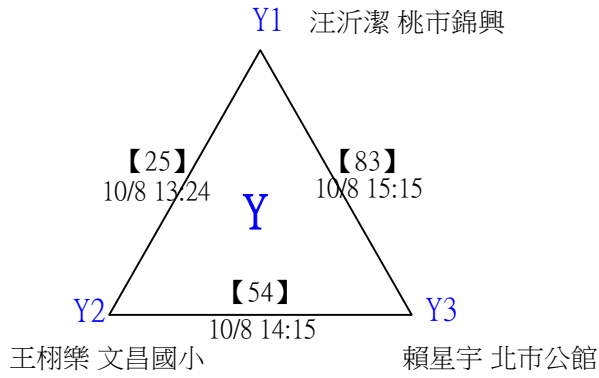

# 2023 婕斯羽你同行 國小暨親子分齡賽

取8名

國小六年級組女單

決賽：三角取一，四角取二，抽籤決定位置。

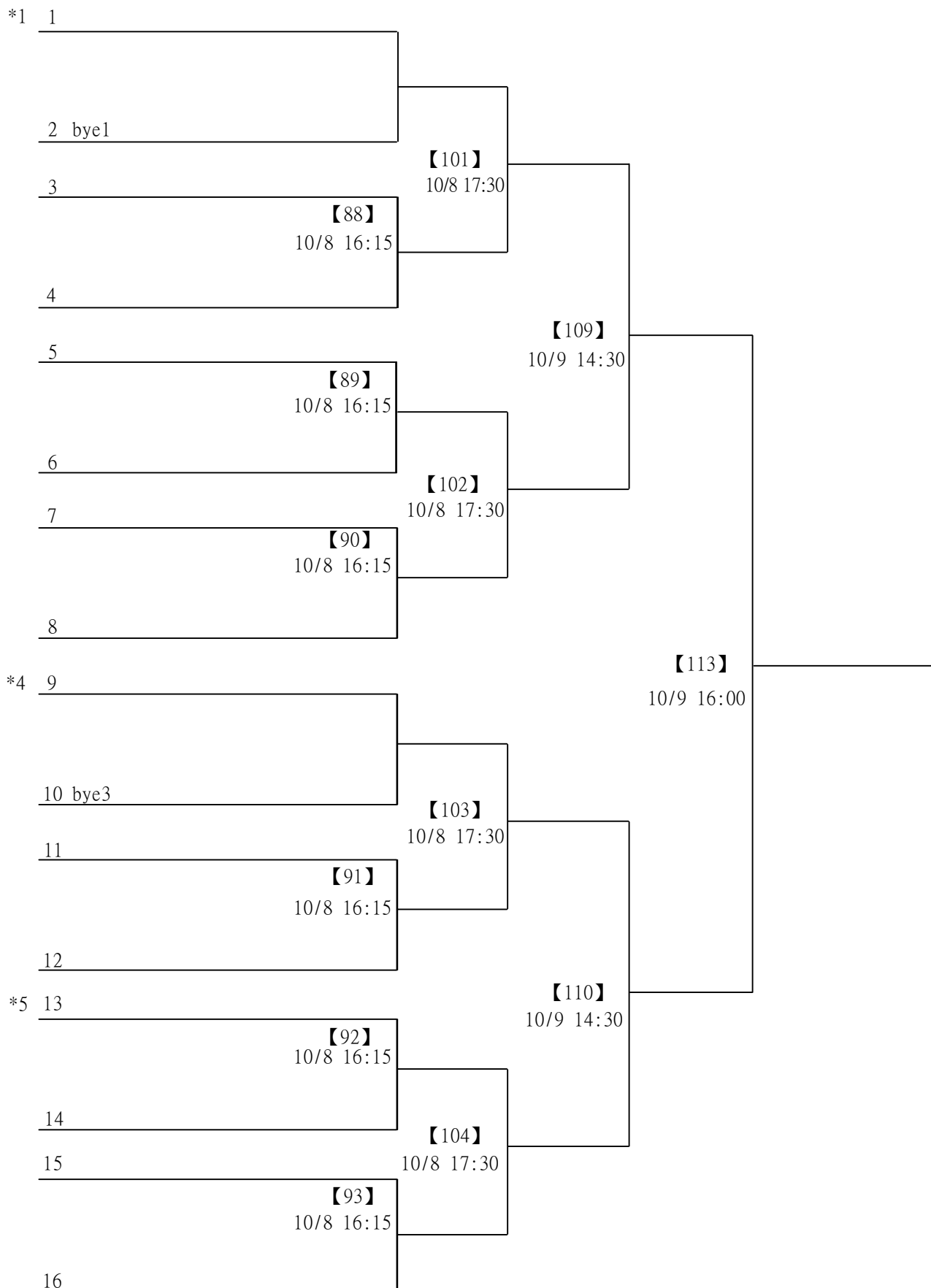

# 2023 婕斯羽你同行 國小暨親子分齡賽

取8名

國小六年級組女單

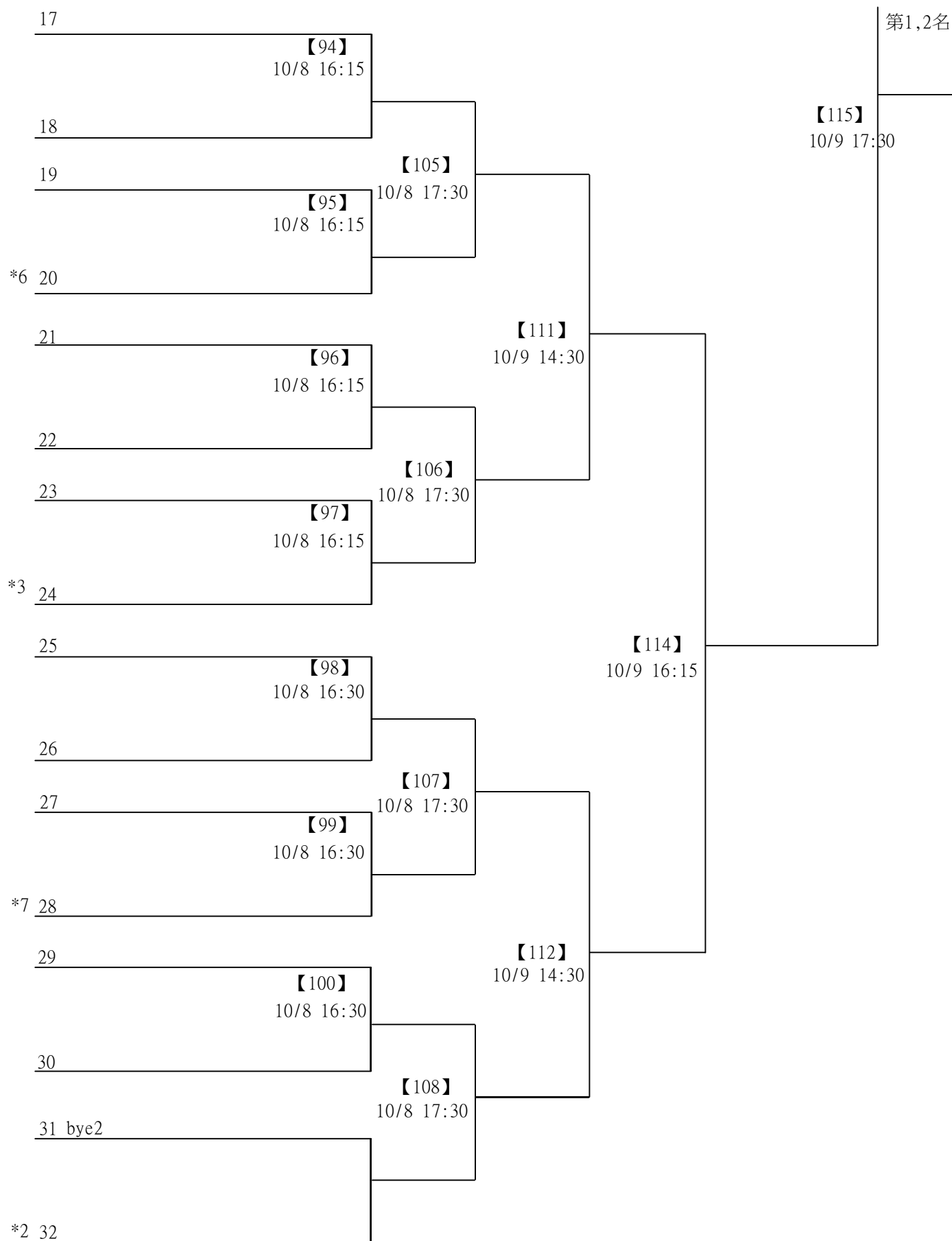

# 2023婕斯羽你同行國小暨親子分齡賽

取16名

國小六年級組男單 共147籤

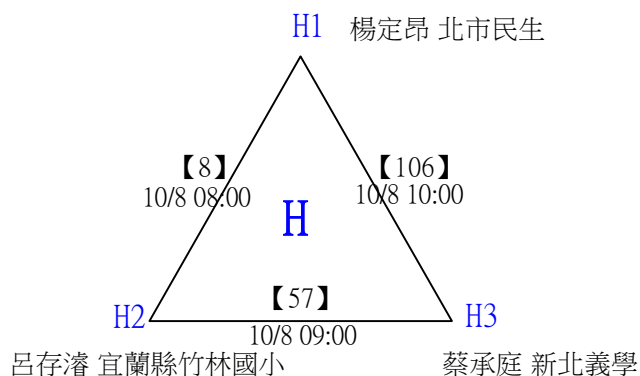
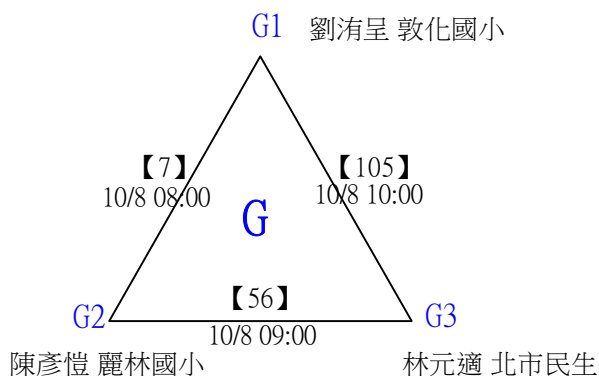
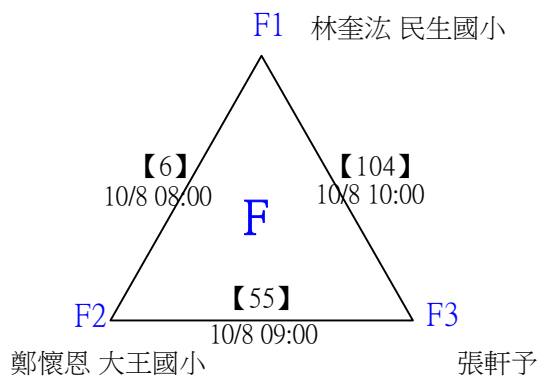
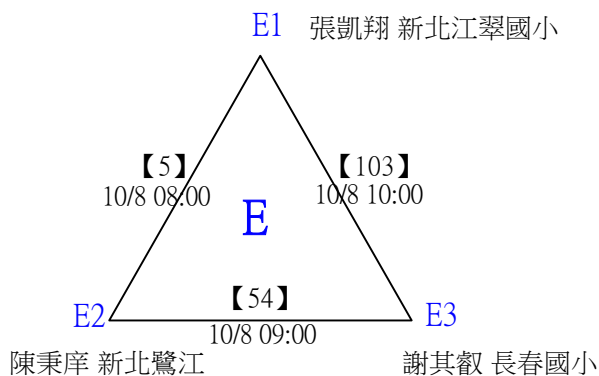
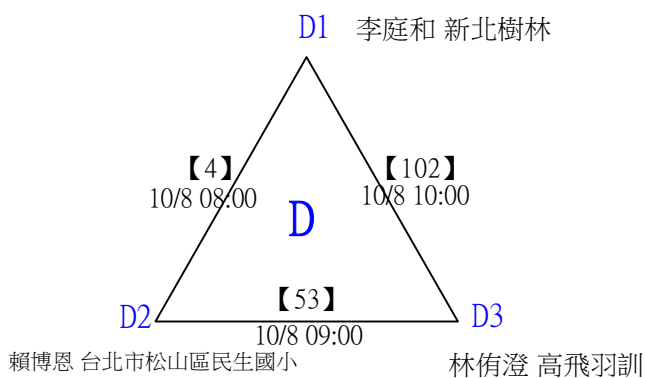
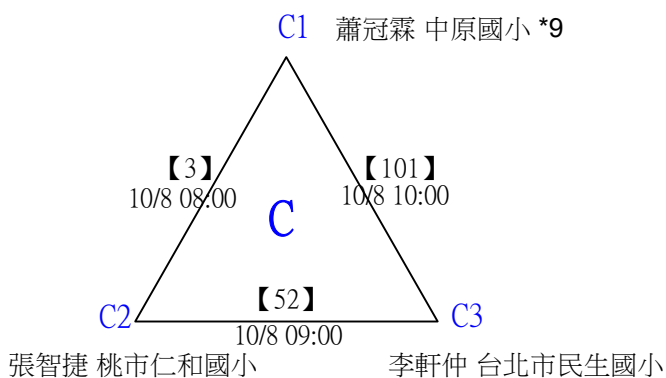
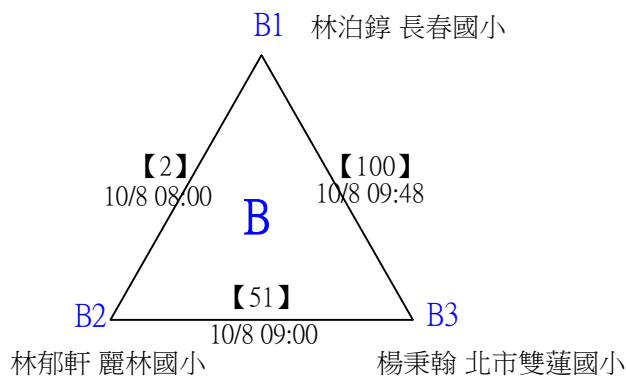
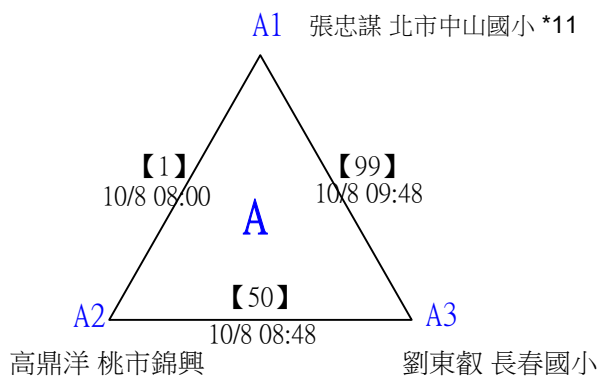

# 2023婕斯羽你同行國小暨親子分齡賽

取16名

國小六年級組男單 共147籤

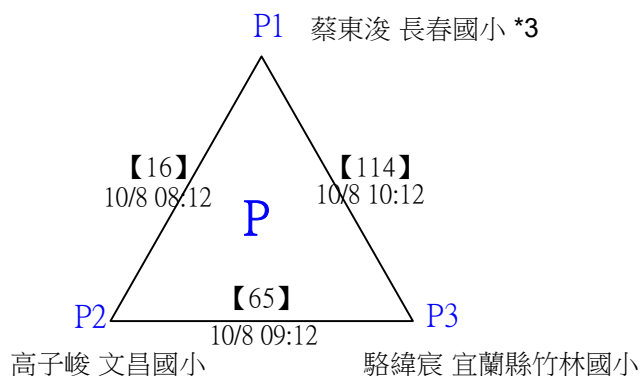
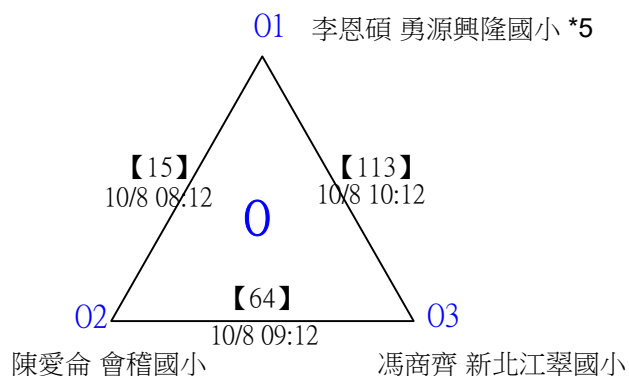
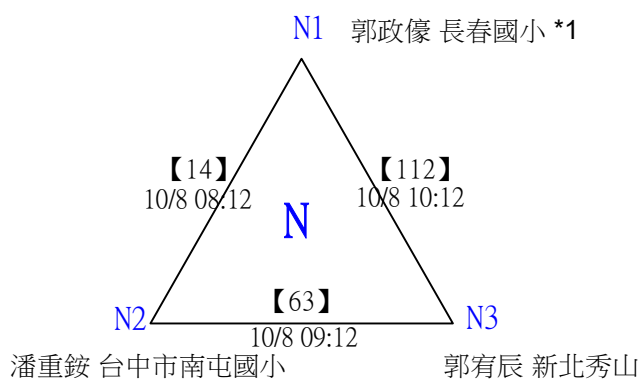
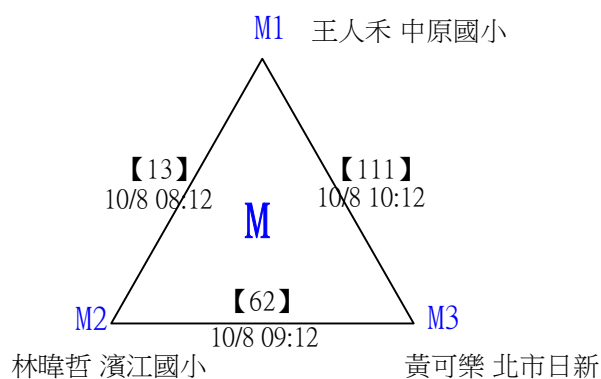
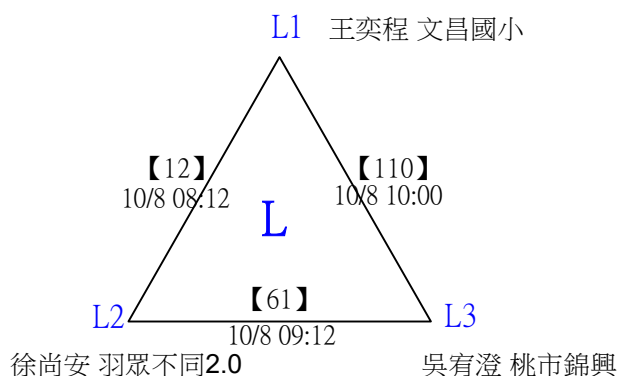
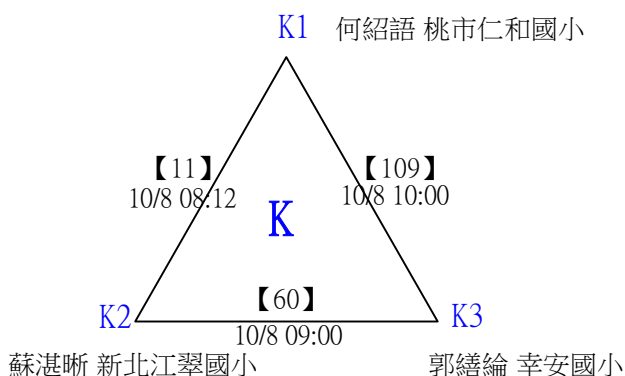
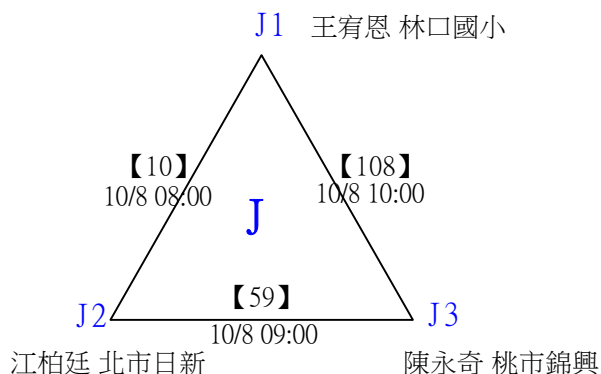
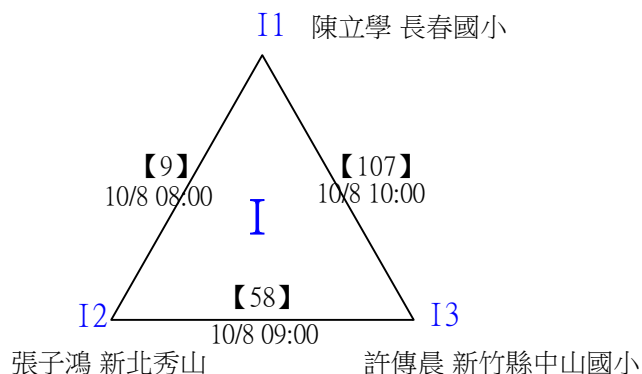

# 2023婕斯羽你同行國小暨親子分齡賽

取16名

國小六年級組男單 共147籤

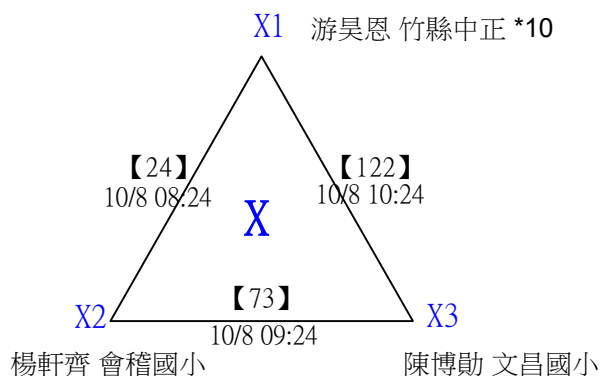
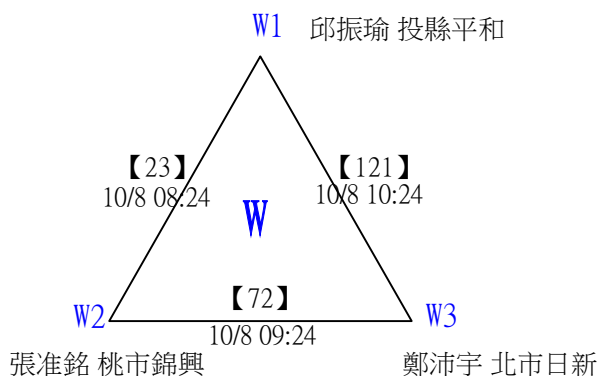
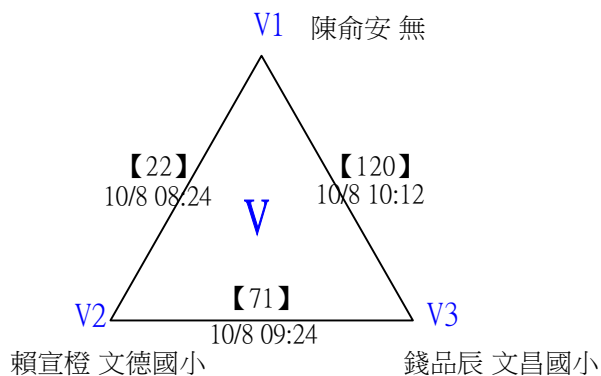
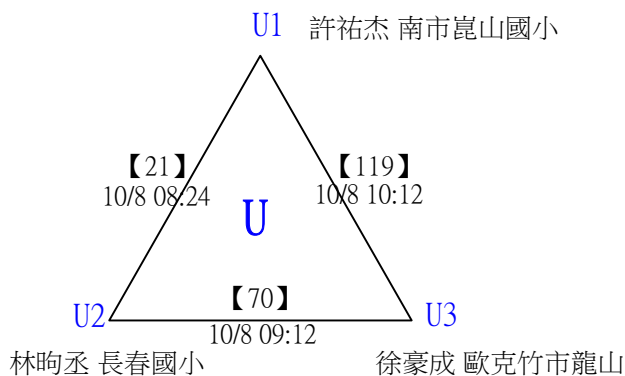
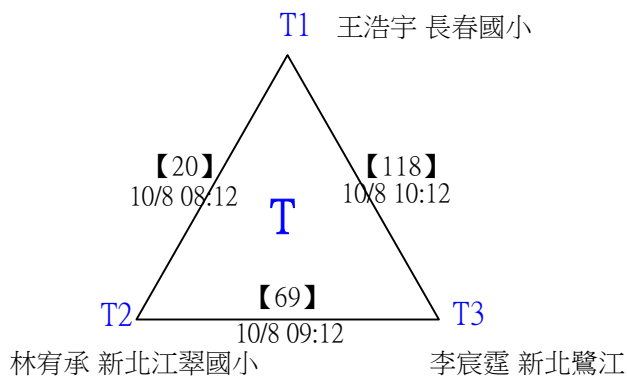
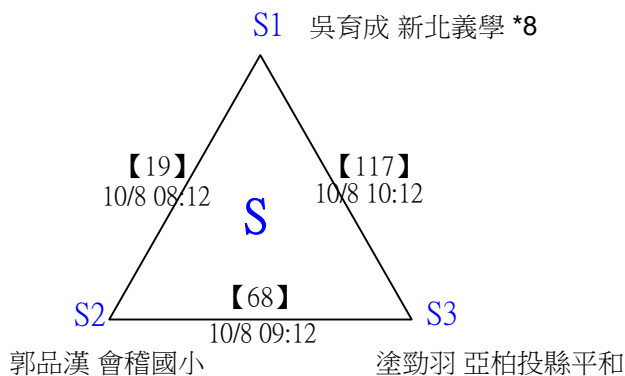
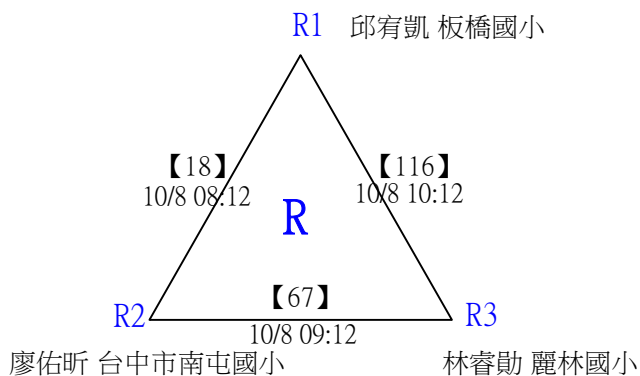
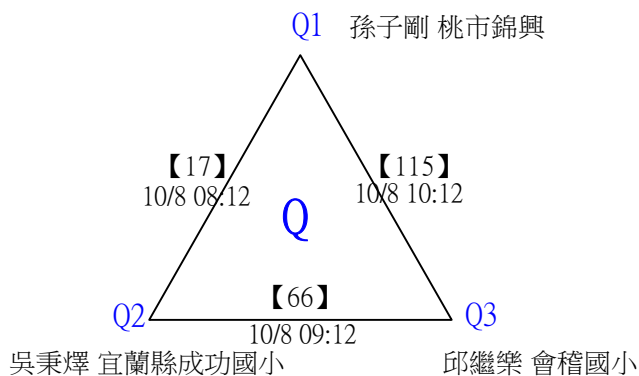

# 2023婕斯羽你同行國小暨親子分齡賽

取16名

國小六年級組男單 共147籤

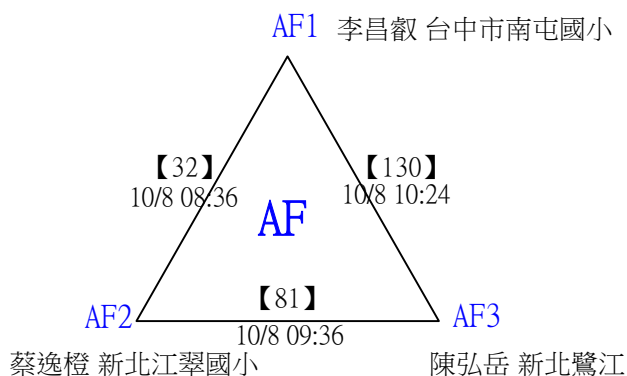
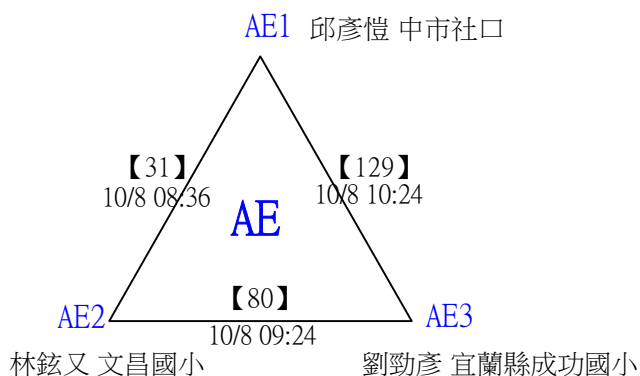
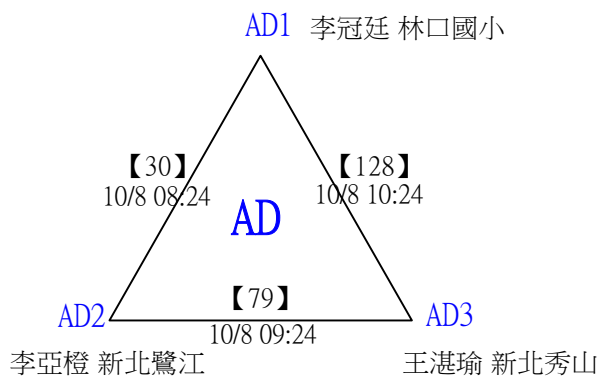
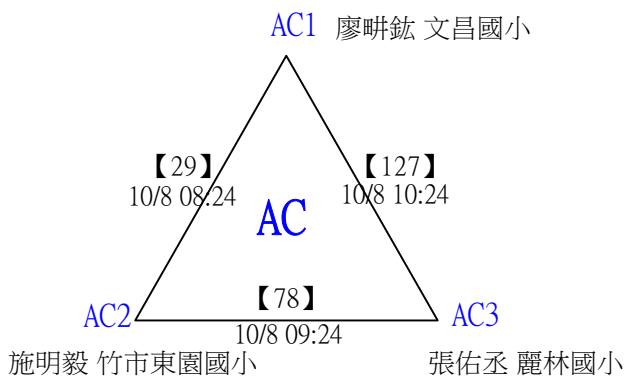
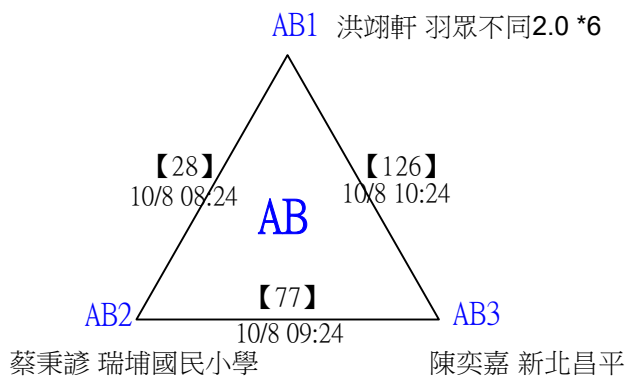
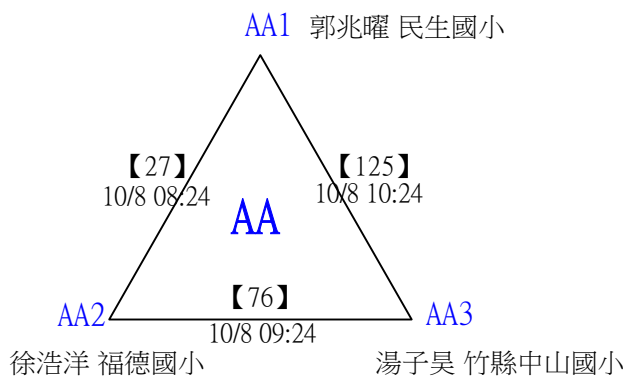
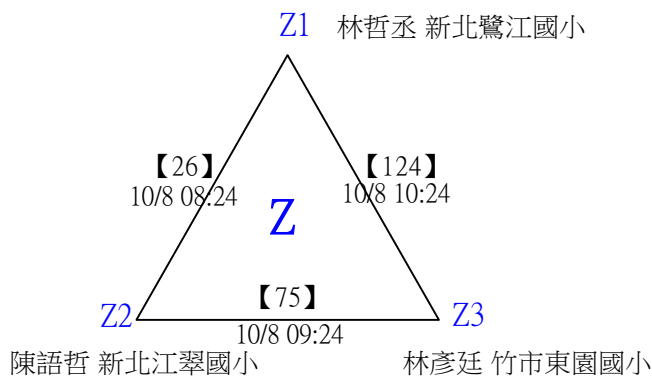
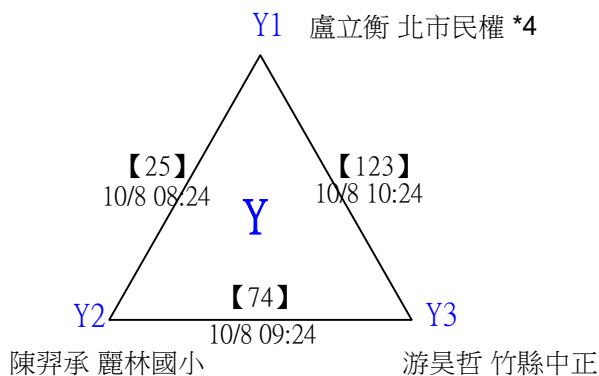



# 2023婕斯羽你同行國小暨親子分齡賽

取16名

國小六年級組男單 共147籤

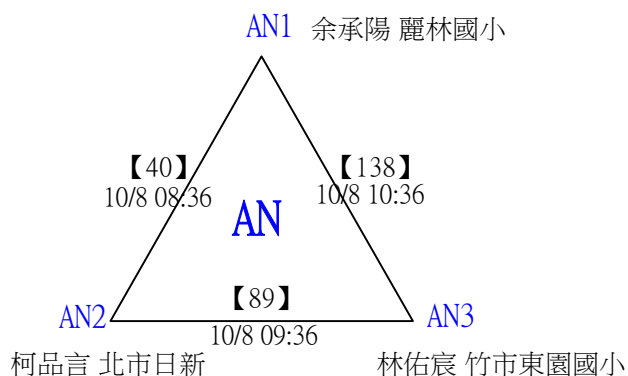
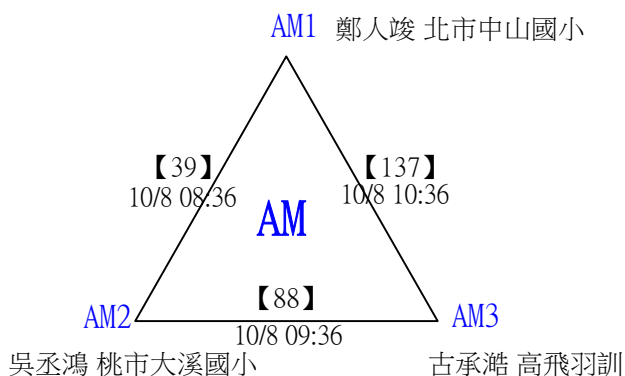
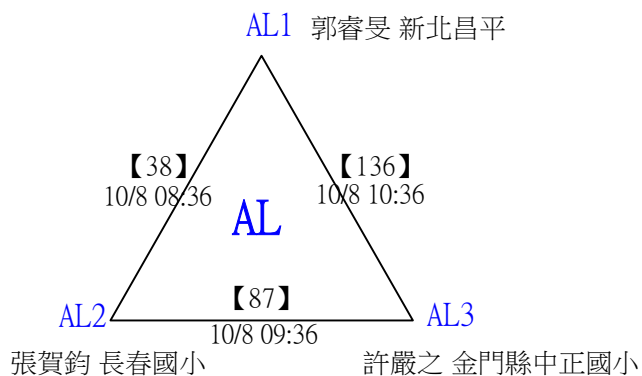
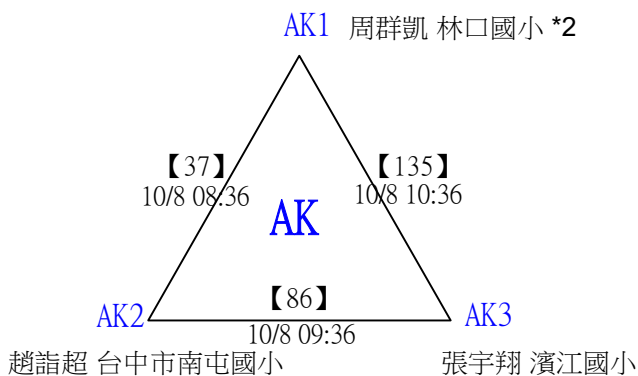
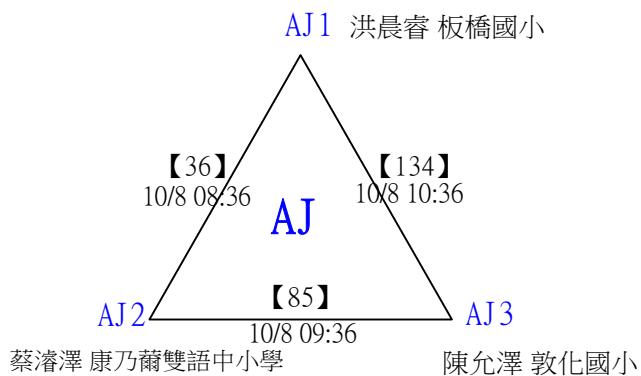
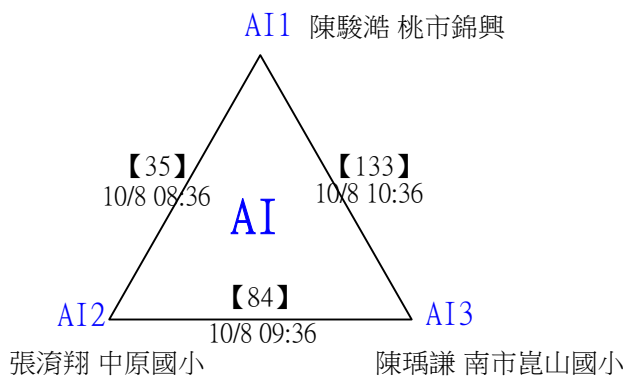
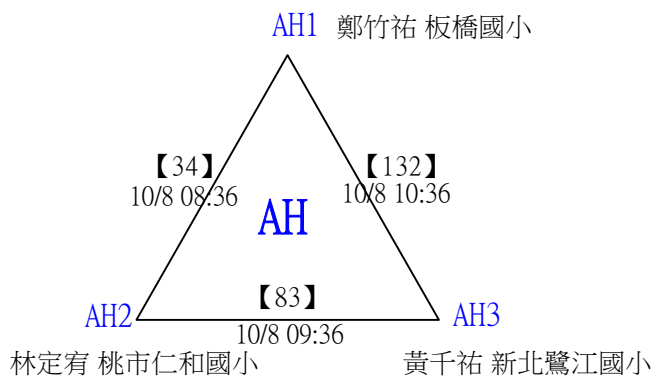
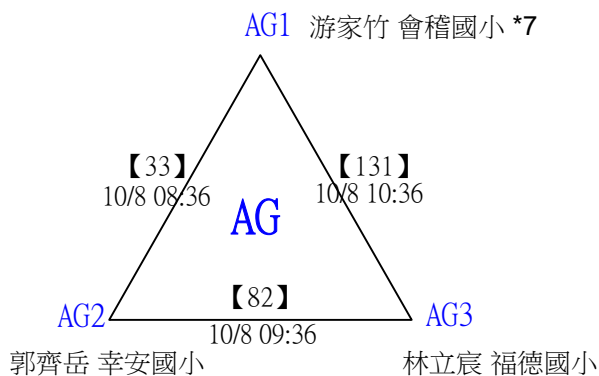

# 2023婕斯羽你同行國小暨親子分齡賽

取16名

國小六年級組男單 共147籤

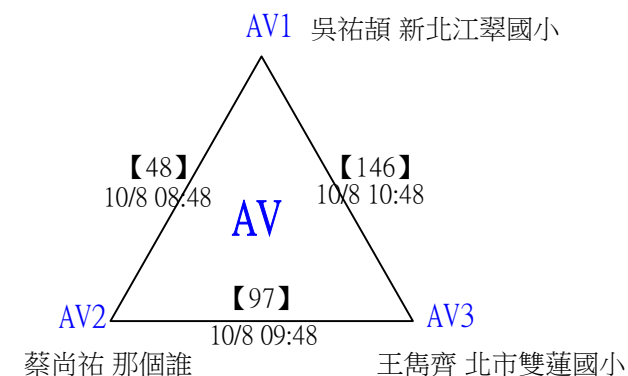
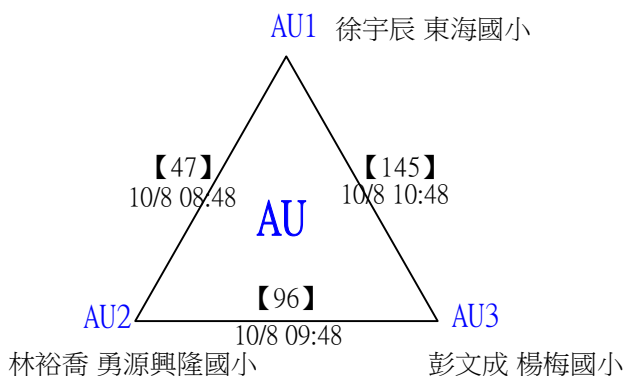
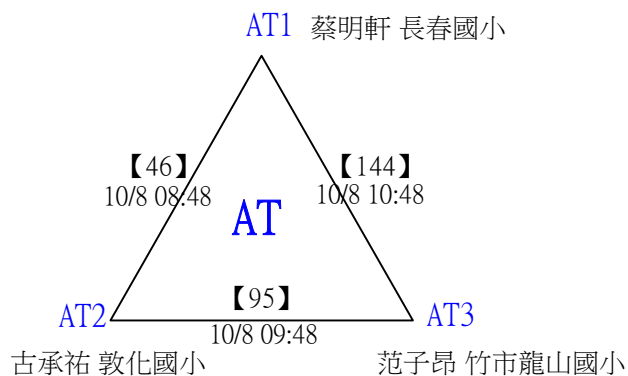
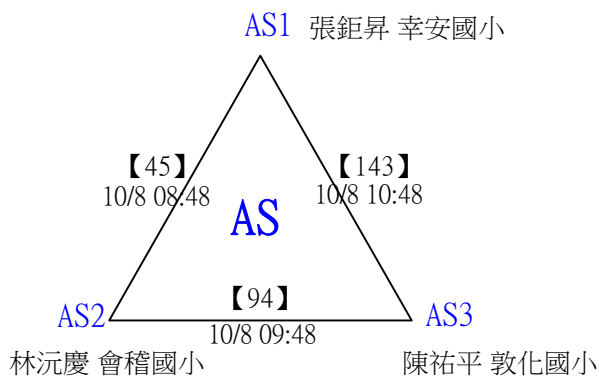
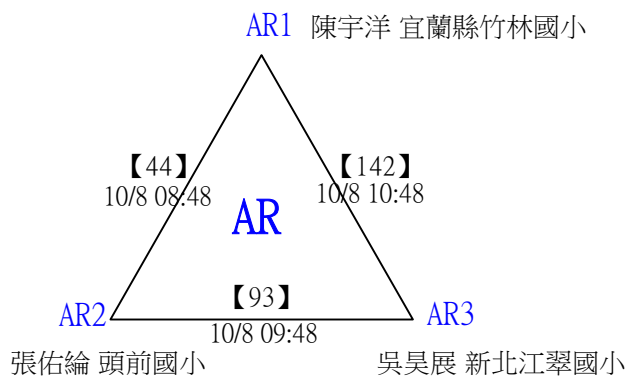
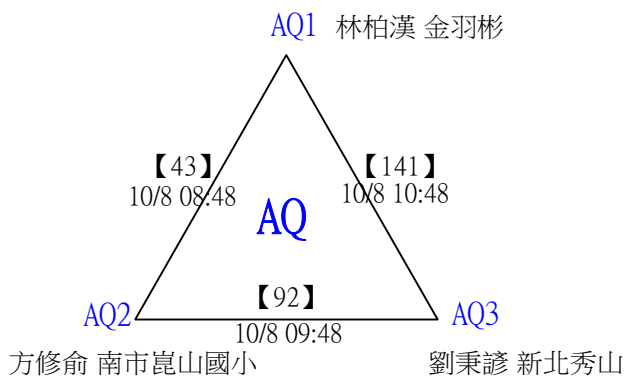
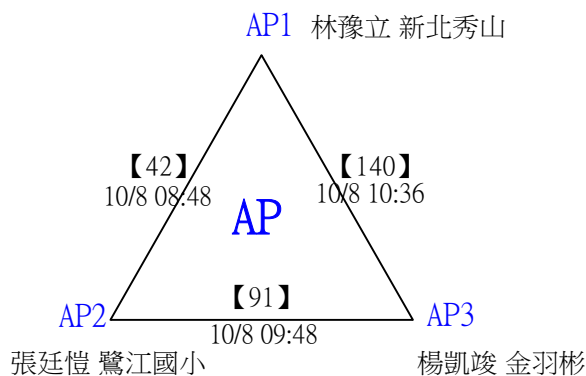
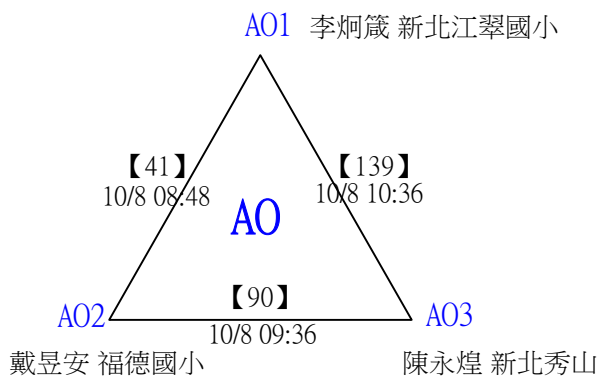

# 2023婕斯羽你同行國小暨親子分齡賽

取16名

國小六年級組男單 共147籤

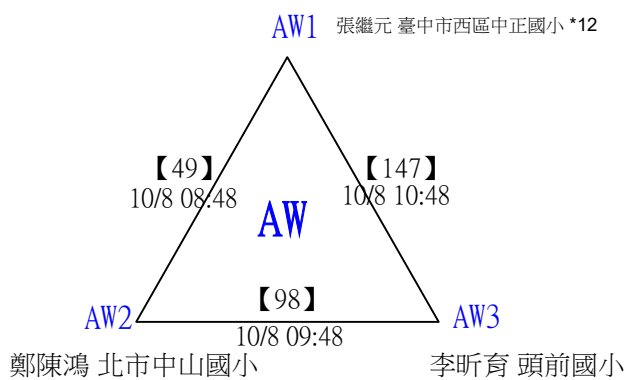

# 2023 婕斯羽你同行 國小暨親子分齡賽

取16名

國小六年級組男單

決賽：三角取一，抽籤決定位置。

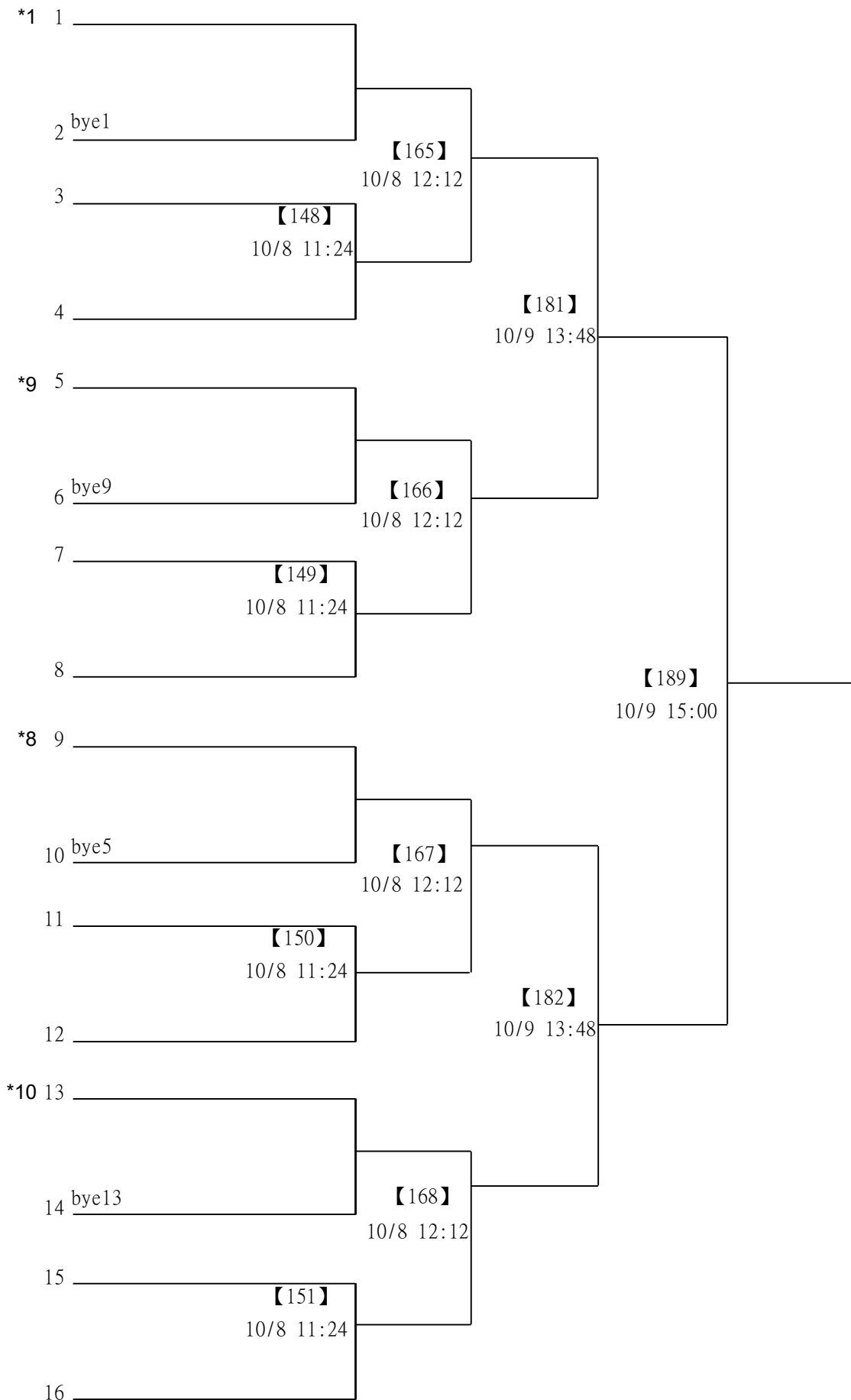

# 2023婕斯羽你同行國小暨親子分齡賽

取16名

國小六年級組男單

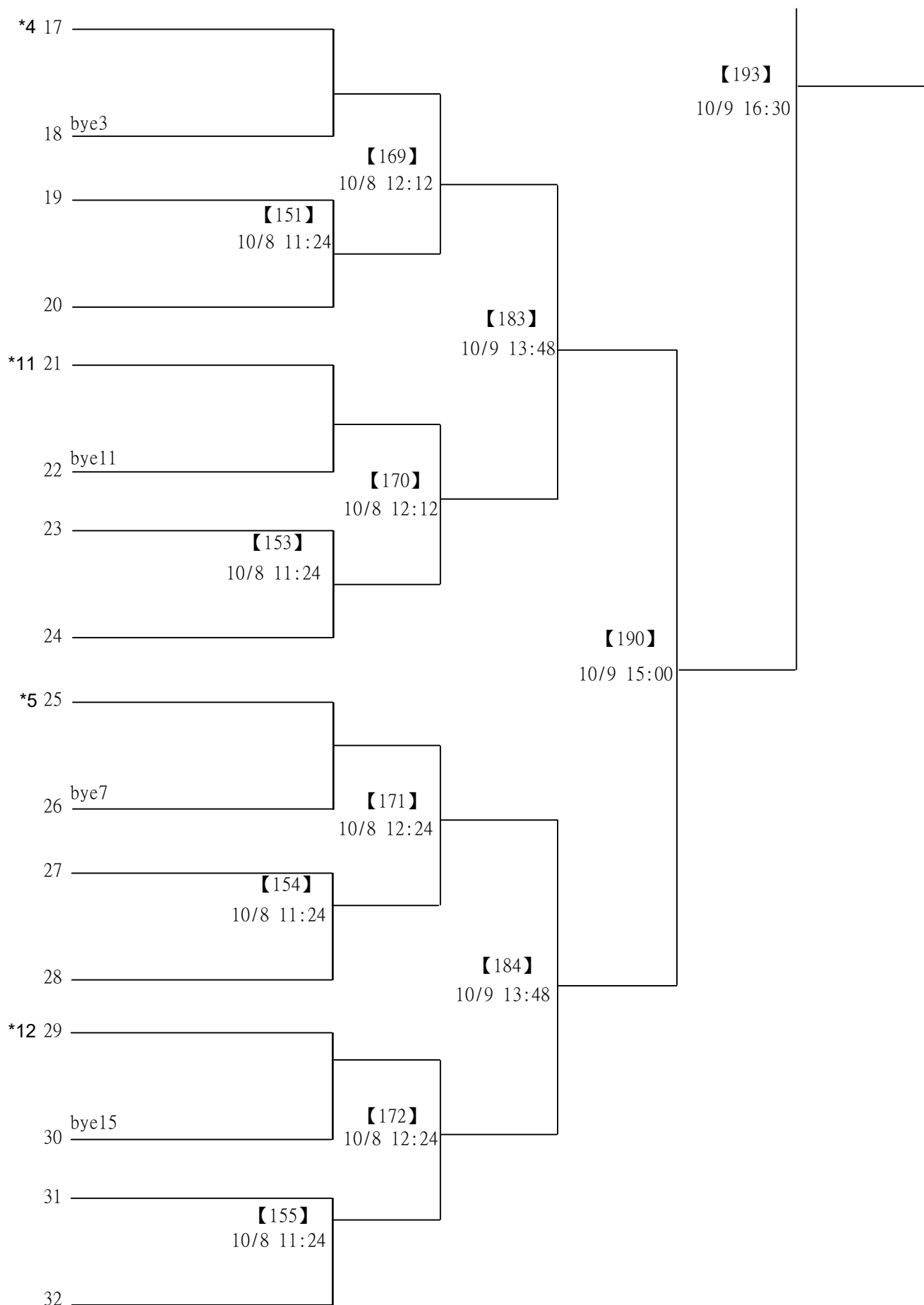

# 2023婕斯羽你同行國小暨親子分齡賽

取16名

國小六年級組男單

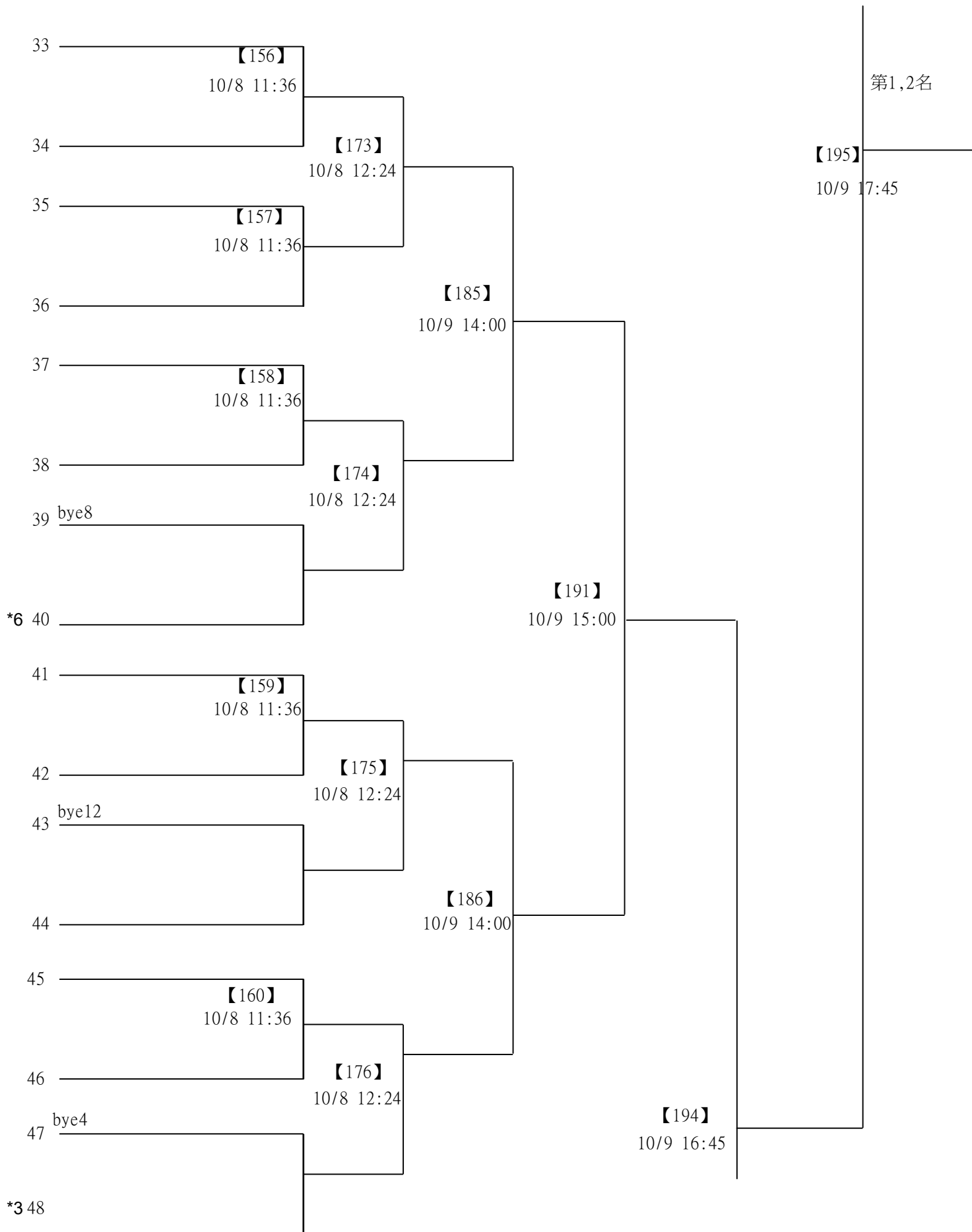

# 2023婕斯羽你同行國小暨親子分齡賽

取16名

國小六年級組男單

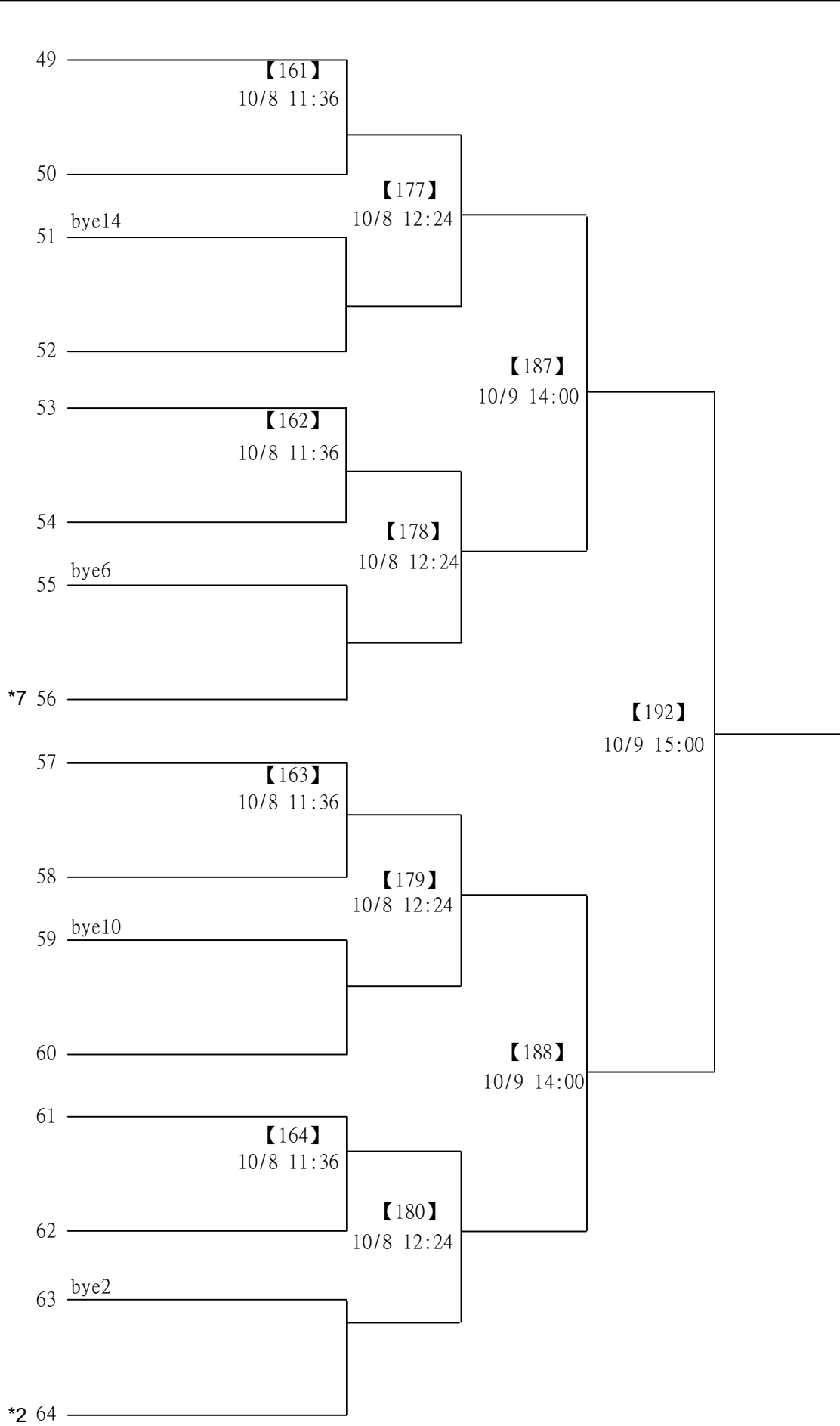

# 2023婕斯羽你同行國小暨親子分齡賽

取4名

國小四年級組女雙 共18籤

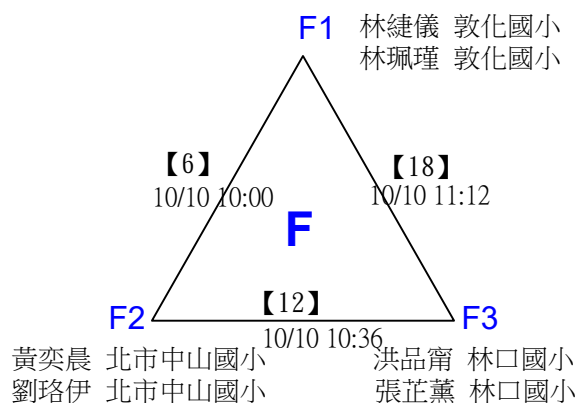
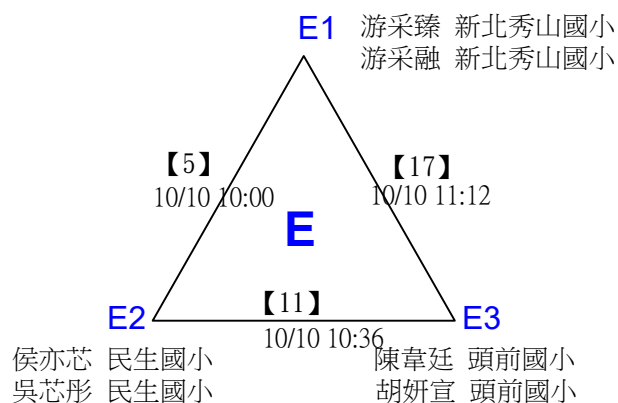
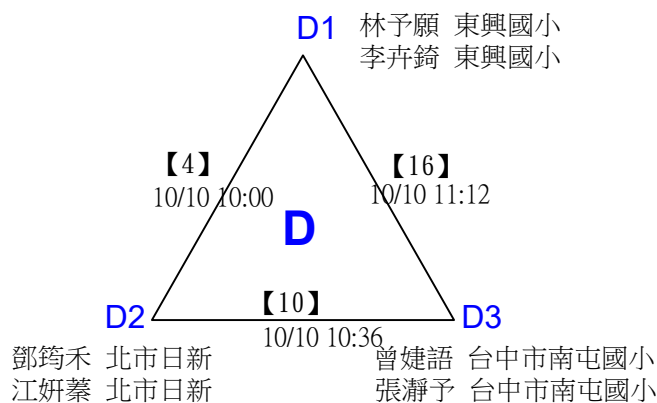
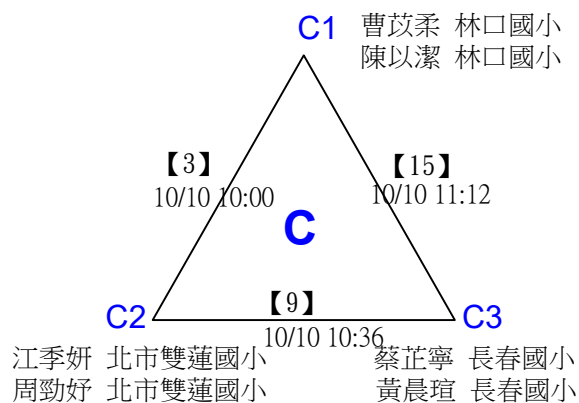
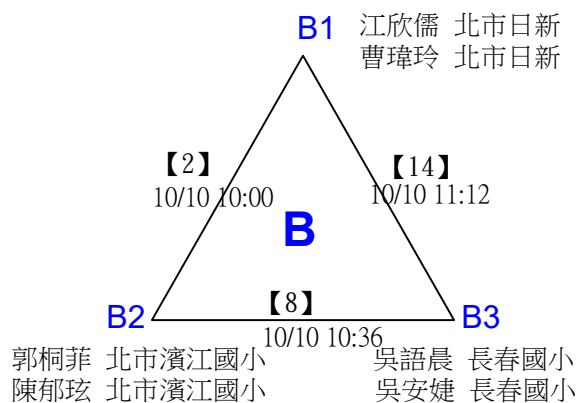
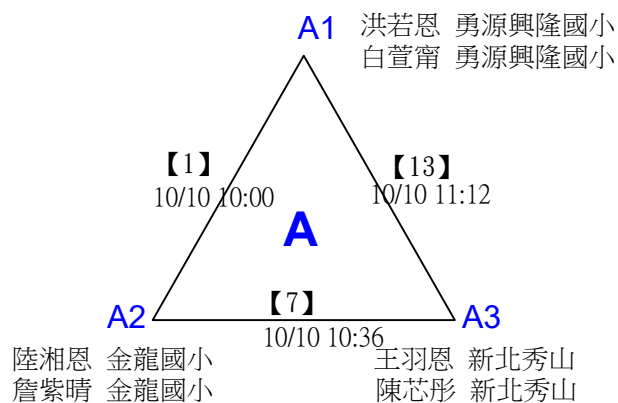



# 2023婕斯羽你同行國小暨親子分齡賽

取4名

國小四年級組女雙

決賽：三角取一，抽籤決定位置。

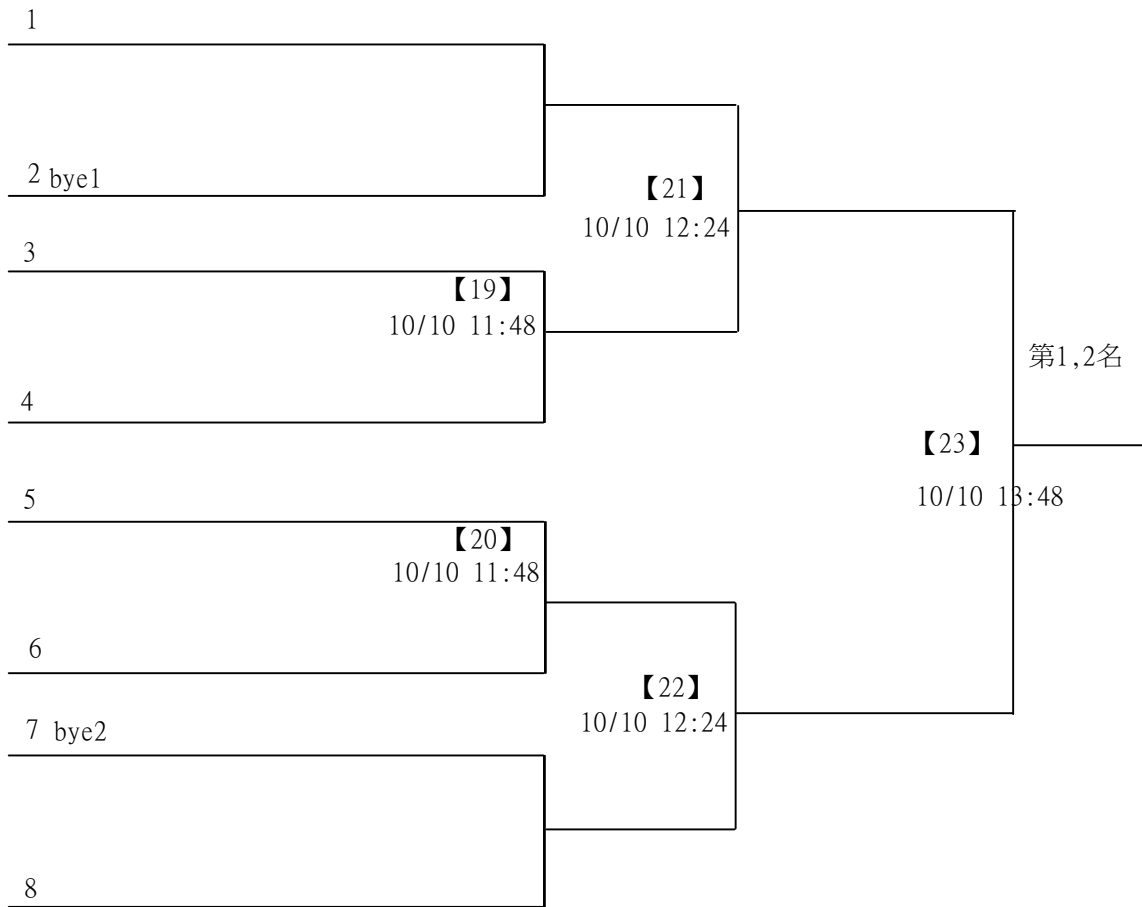

# 2023婕斯羽你同行國小暨親子分齡賽

取8名

國小四年級組男雙 共53籤

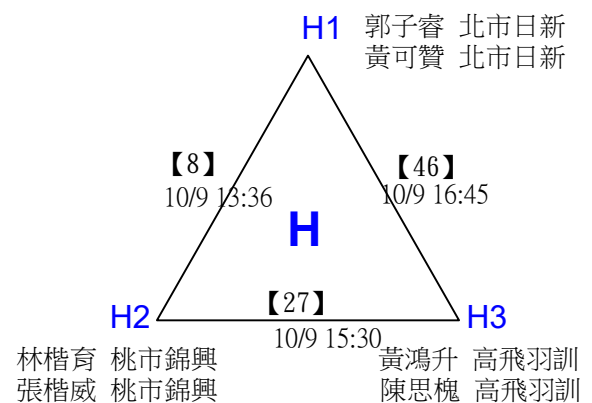
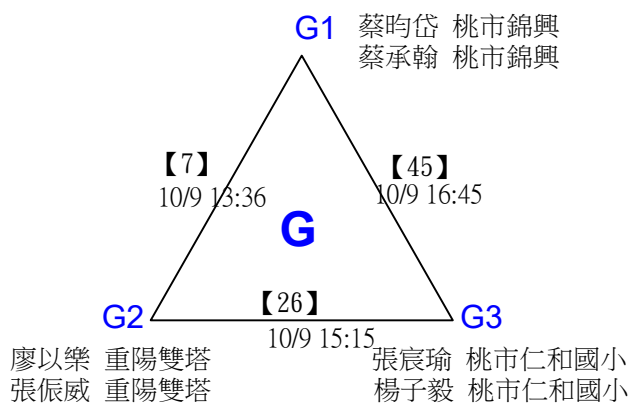
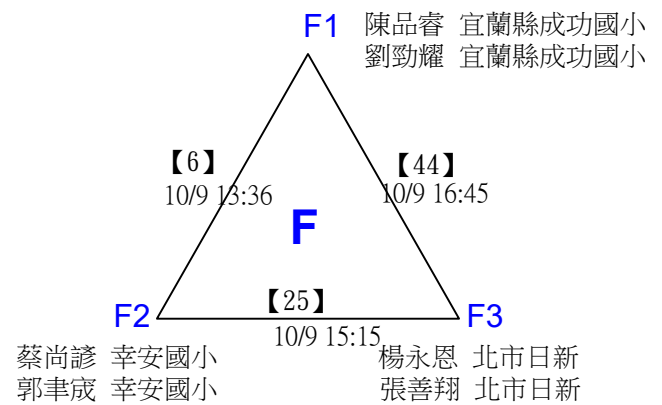
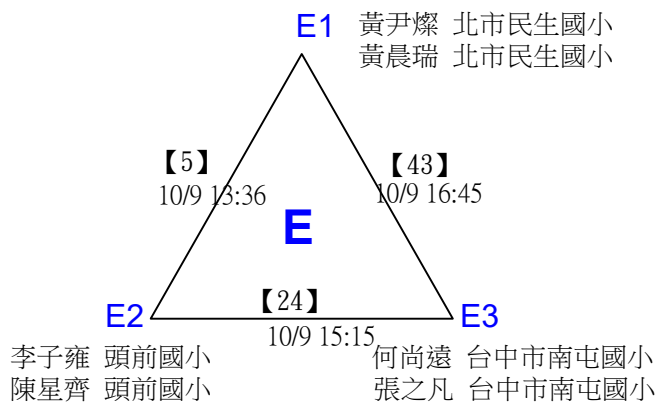
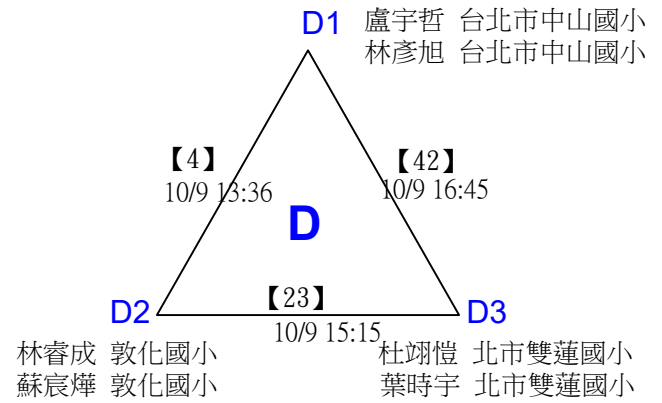
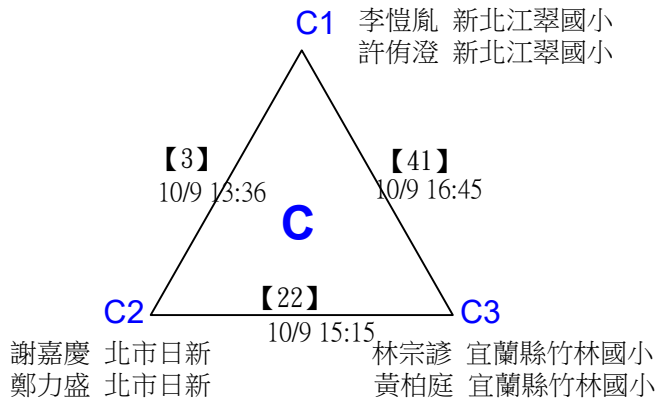
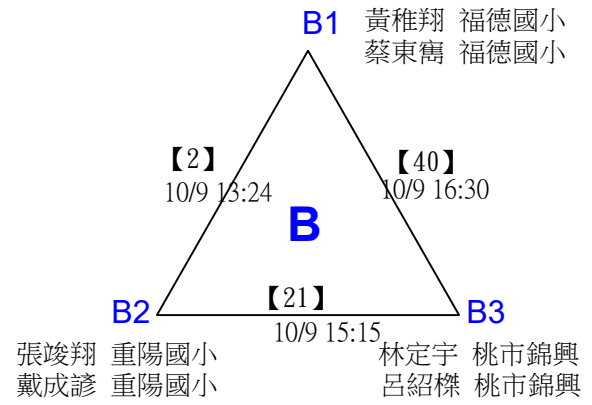
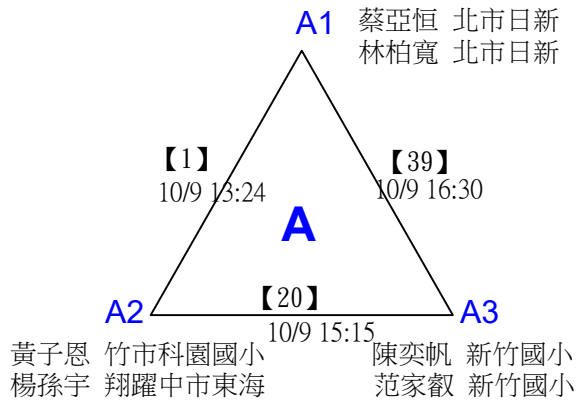

# 2023捷斯羽你同行國小暨親子分齡賽

取8名

國小四年級組男雙 共53籤

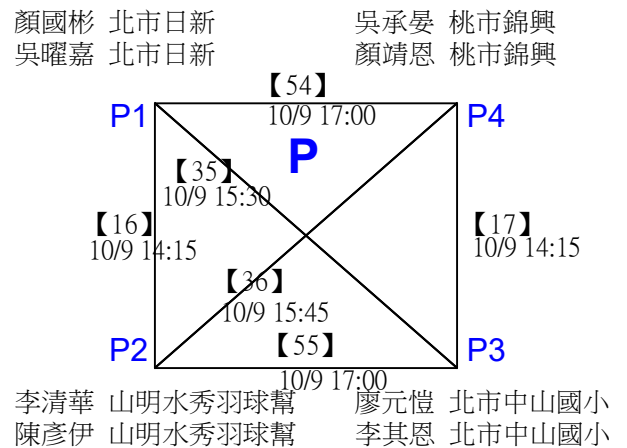
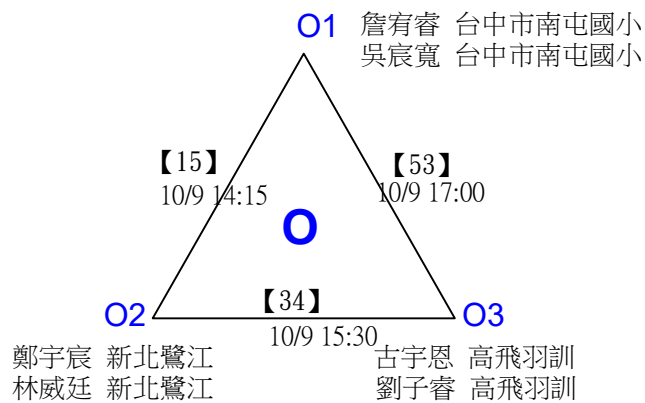
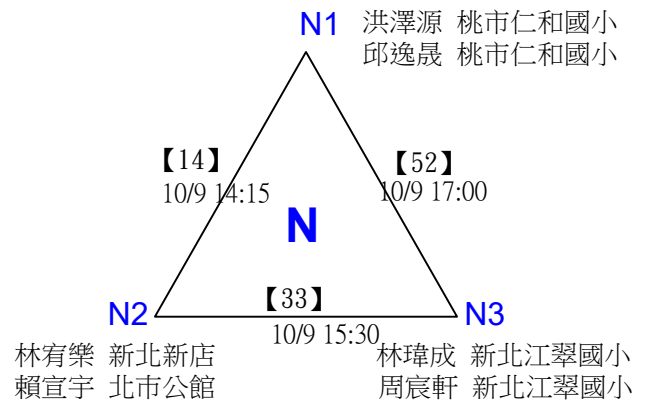
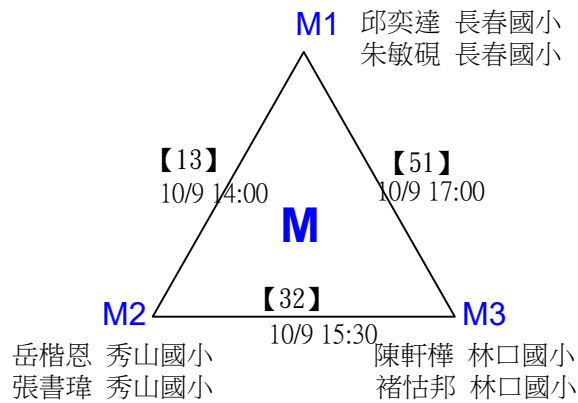
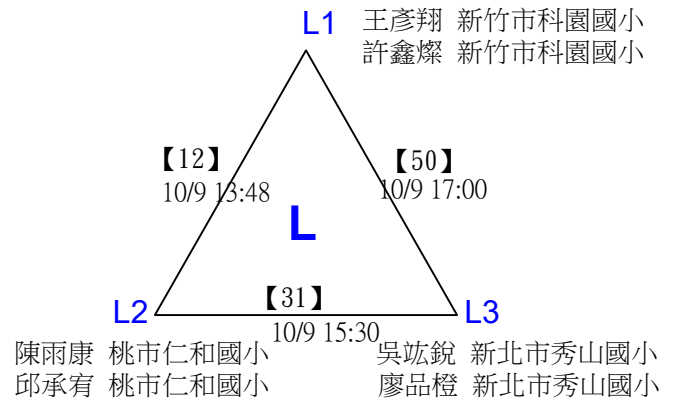
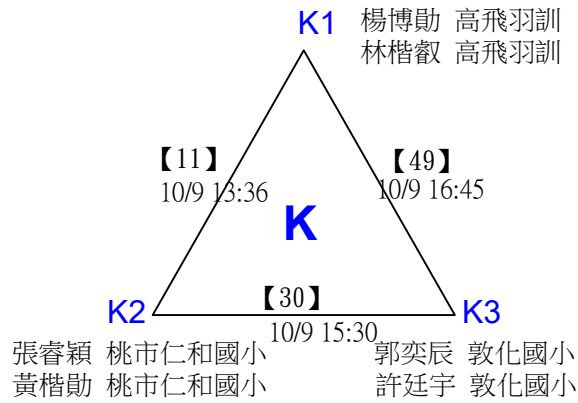
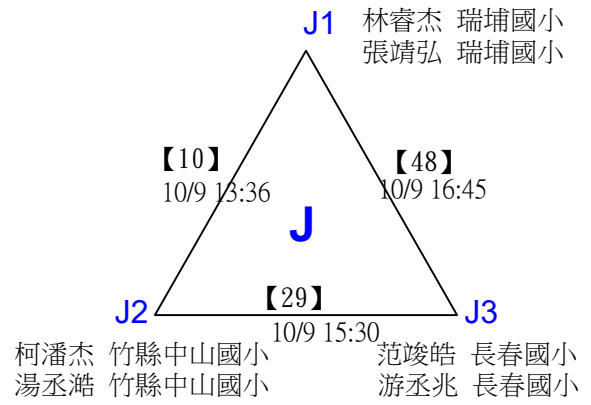
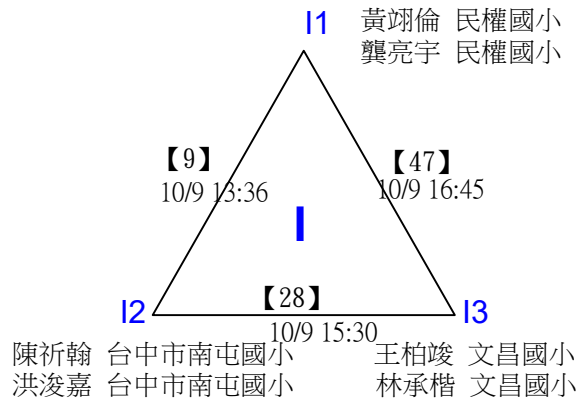

# 2023 婕斯羽你同行 國小暨親子分齡賽

國小四年級組男雙 共53籤

取8名

梁宇辰 高飛羽訓      嚴守序 北市-民權國小  
吳瑞揚 高飛羽訓      陳廣哲 北市-民權國小

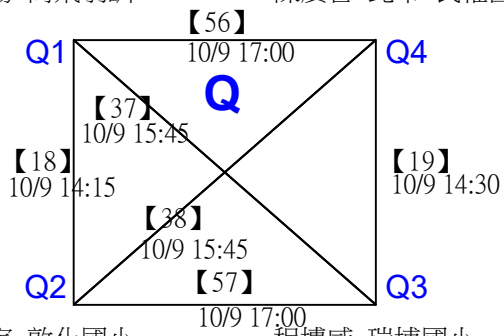

陳冠宇 敦化國小      程博威 瑞埔國小  
楊侑勳 敦化國小      何煜凡 瑞埔國小

# 2023 婕斯羽你同行 國小暨親子分齡賽

取8名

國小四年級組男雙

決賽：三角取一，四角取二，抽籤決定位置。

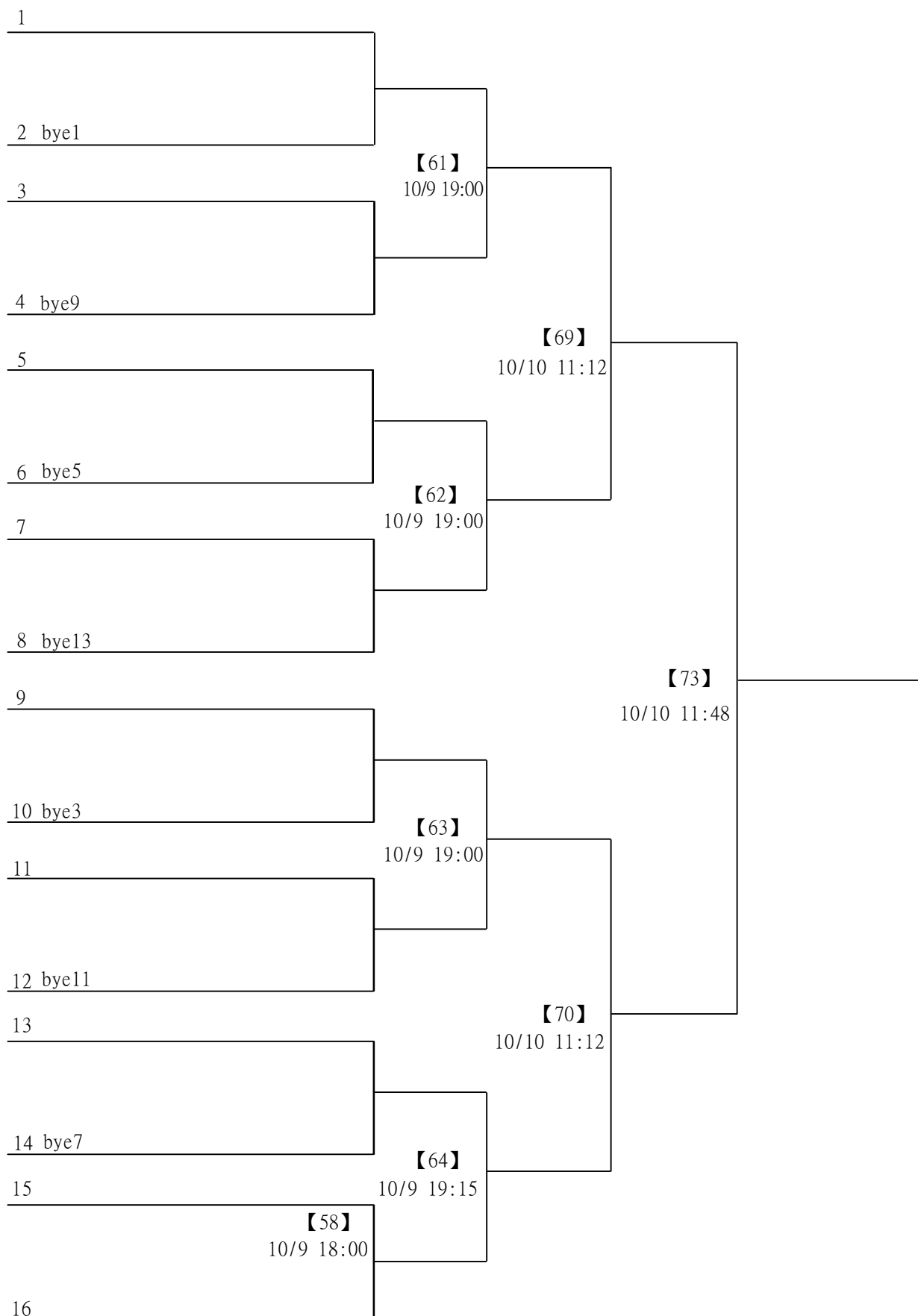

# 2023 婕斯羽你同行 國小暨親子分齡賽

取8名

國小四年級組男雙

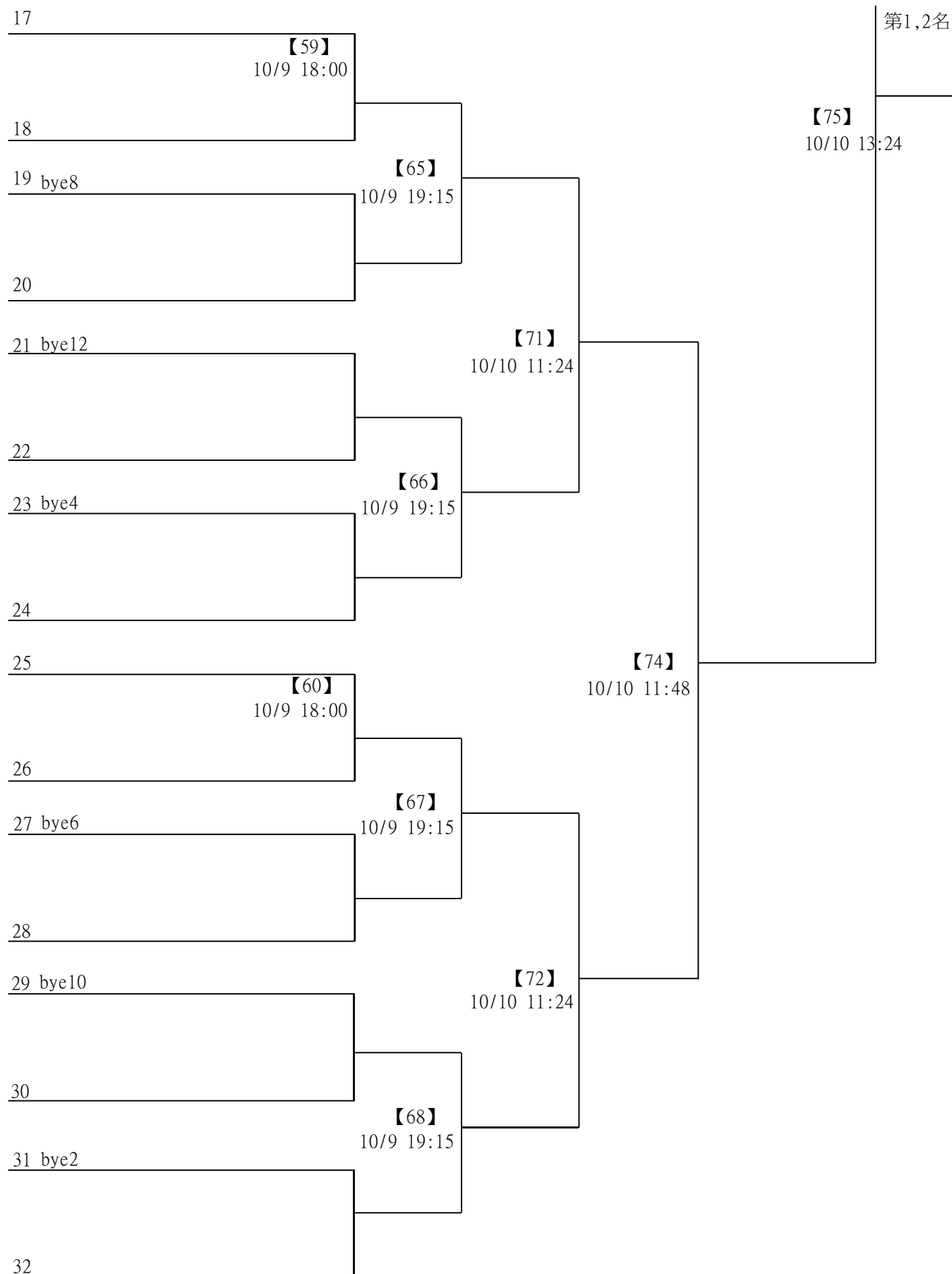

# 2023婕斯羽你同行國小暨親子分齡賽

取4名

國小五年級組女雙 共29籤

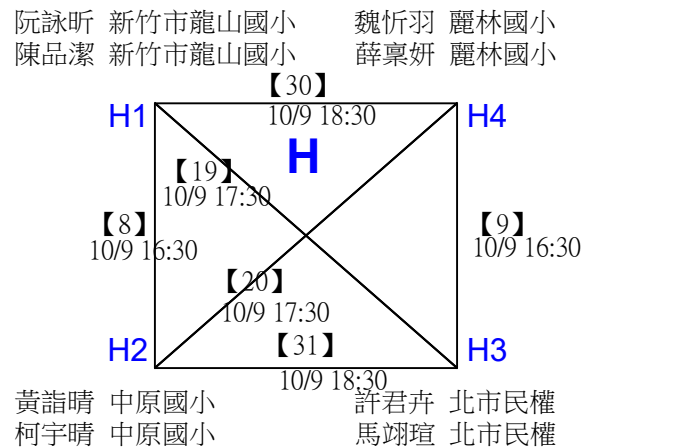
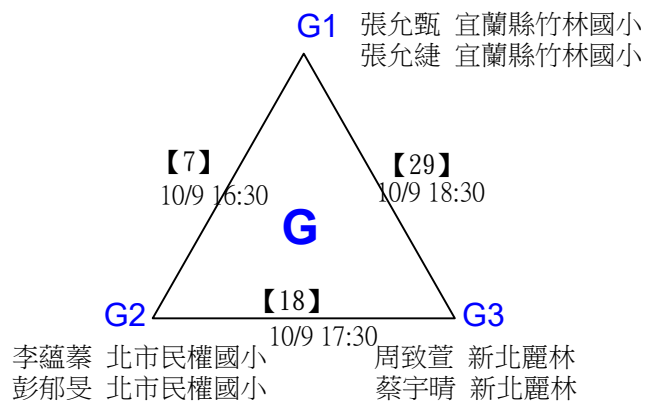
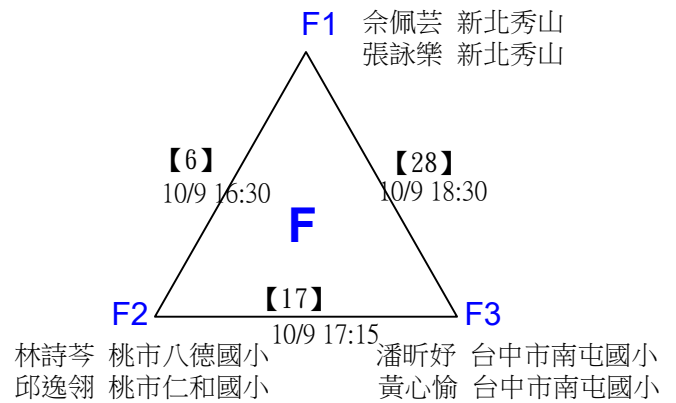
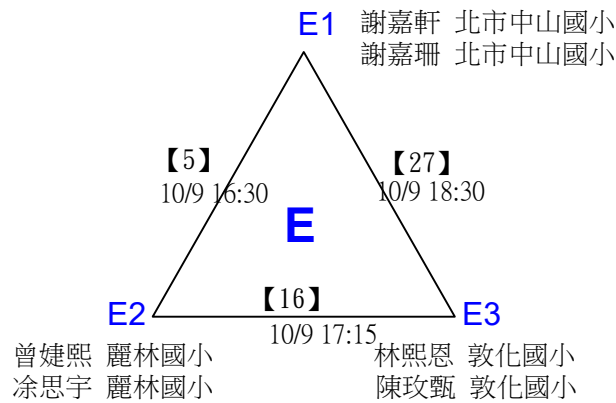
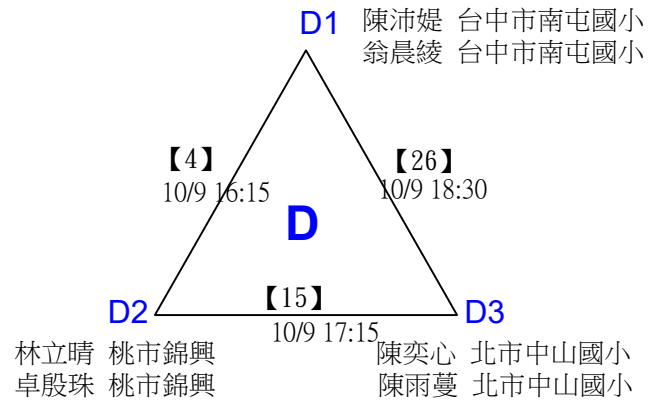
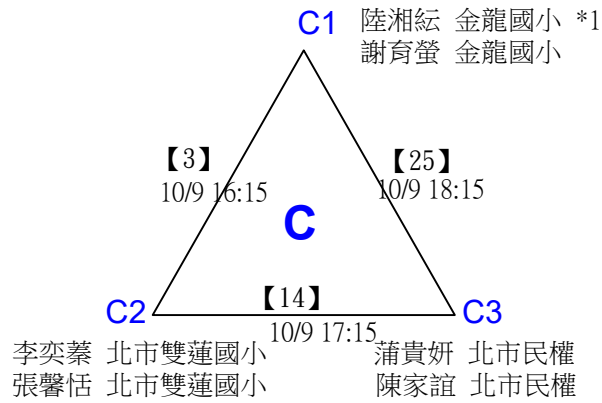
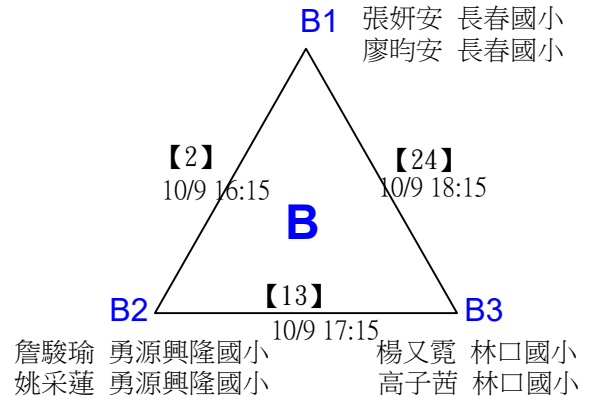
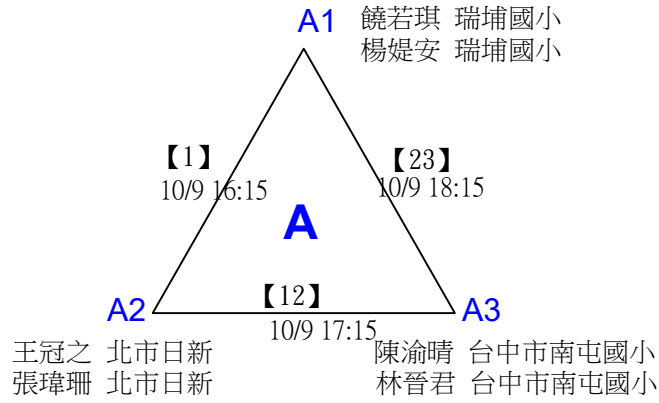

# 2023婕斯羽你同行國小暨親子分齡賽

國小五年級組女雙 共29籤

取4名

陳昀安 北市中山國小      何昕霓 新竹市龍山國小  
 黃暉婷 北市中山國小      楊舒晴 新竹市龍山國小

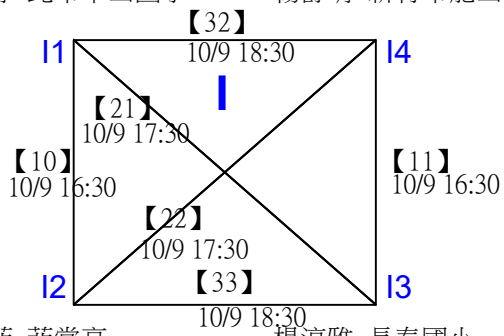

李均菲 菲常亮      楊淳雅 長春國小  
 吳安婕 菲常亮      賴祥希 長春國小



# 2023 婕斯羽你同行 國小暨親子分齡賽

國小五年級組女雙

取4名

決賽：三角取一，四角取二，抽籤決定位置。

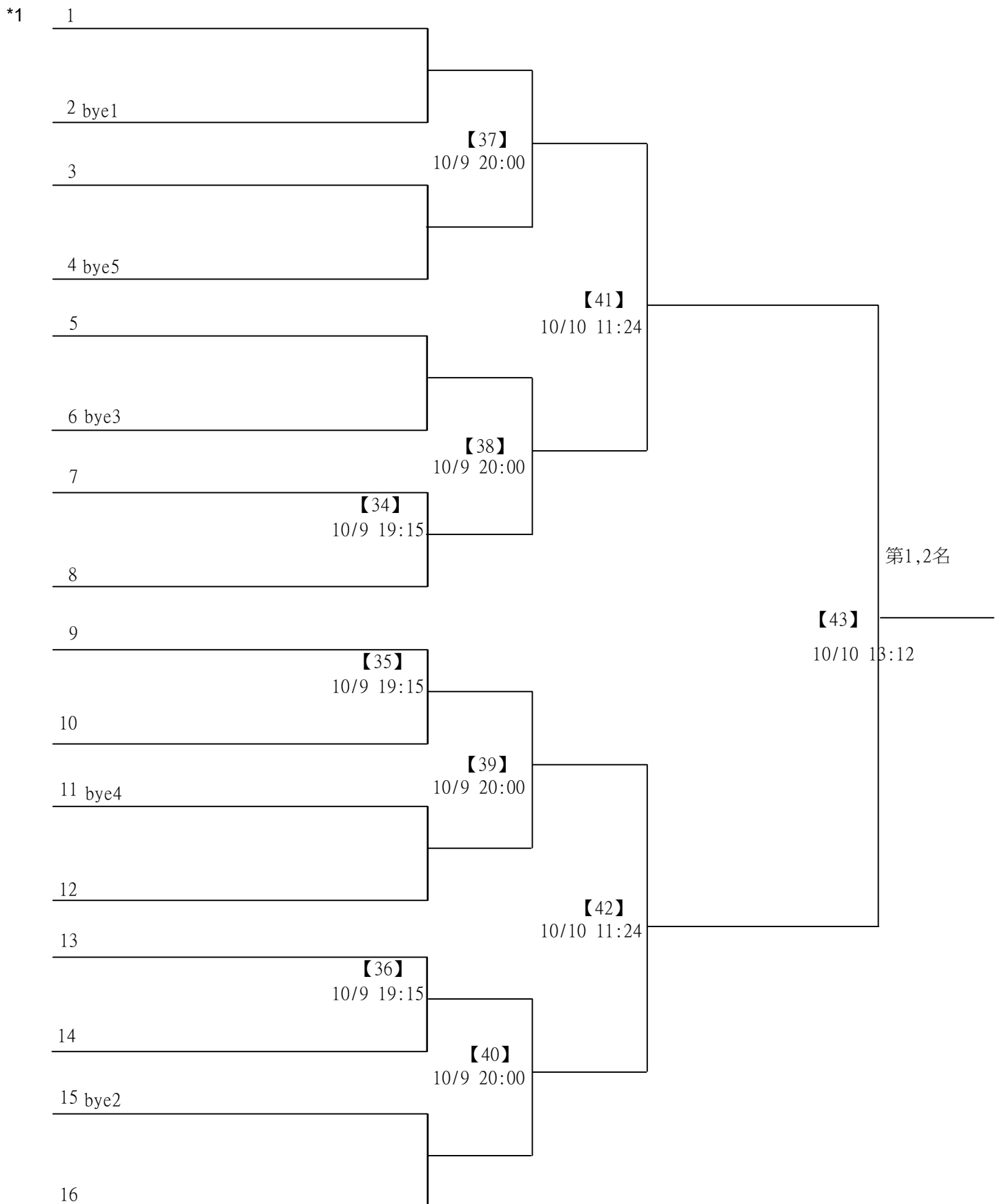

# 2023 婕斯羽你同行 國小暨親子分齡賽

取8名

國小五年級組男雙 共53籤

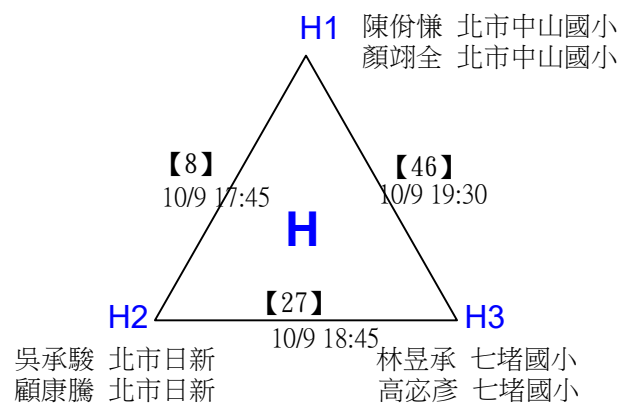
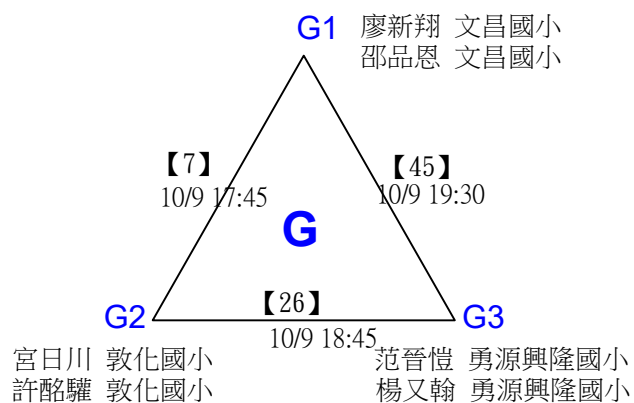
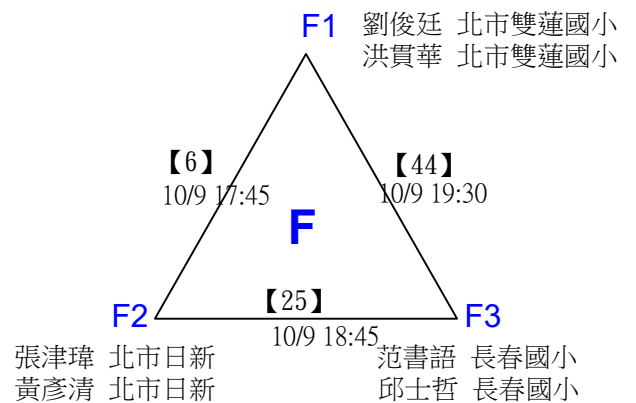
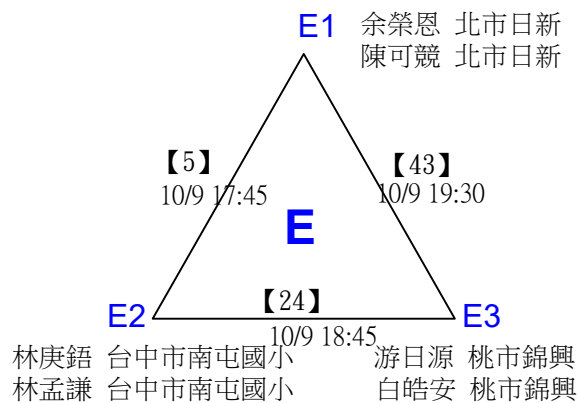
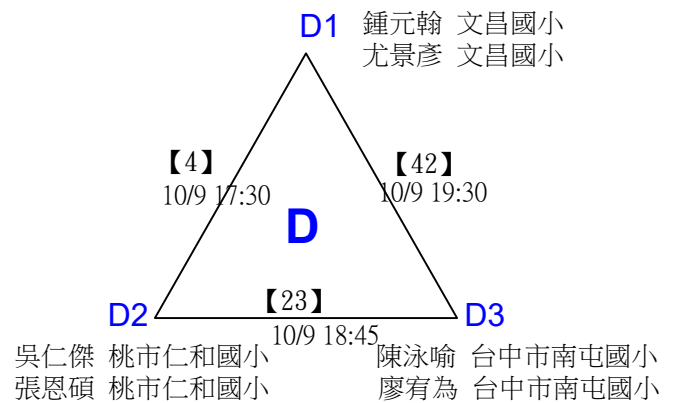
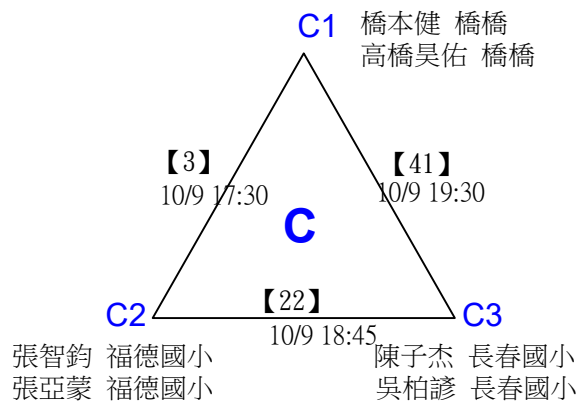
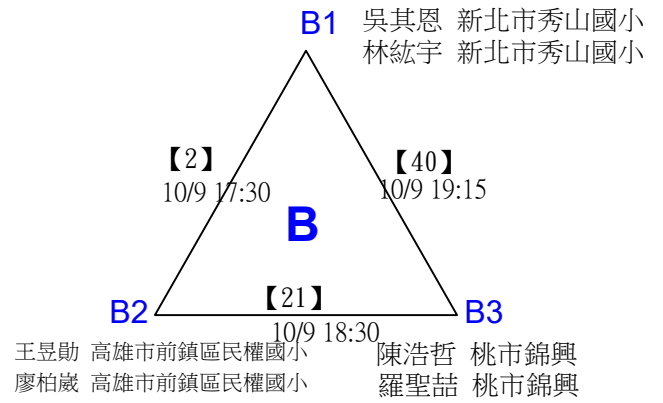
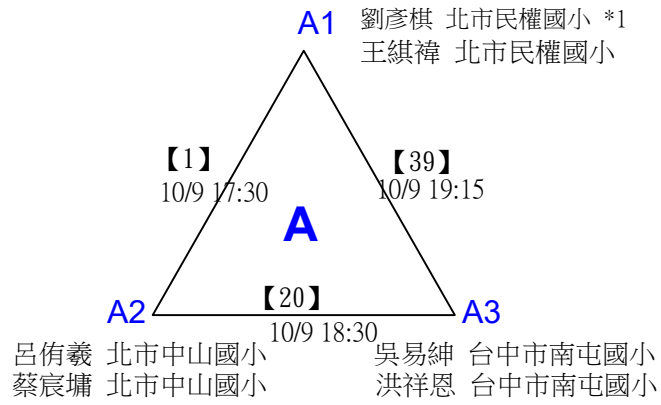

# 2023婕斯羽你同行國小暨親子分齡賽

取8名

國小五年級組男雙 共53籤

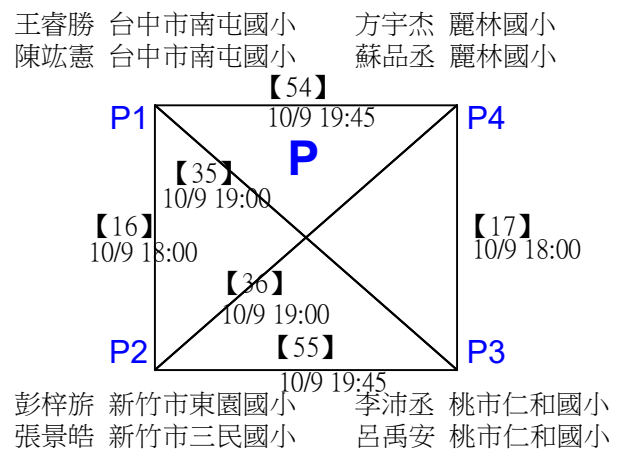
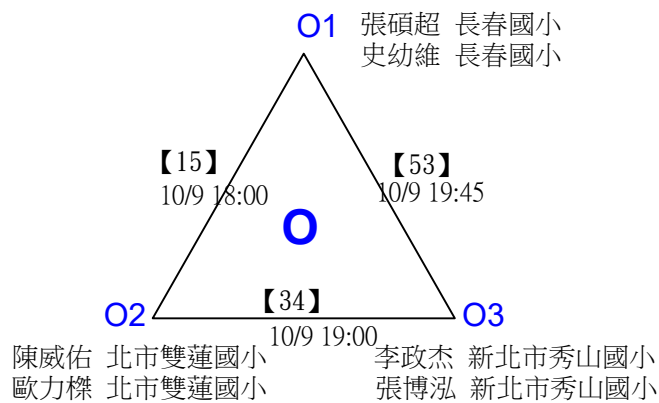
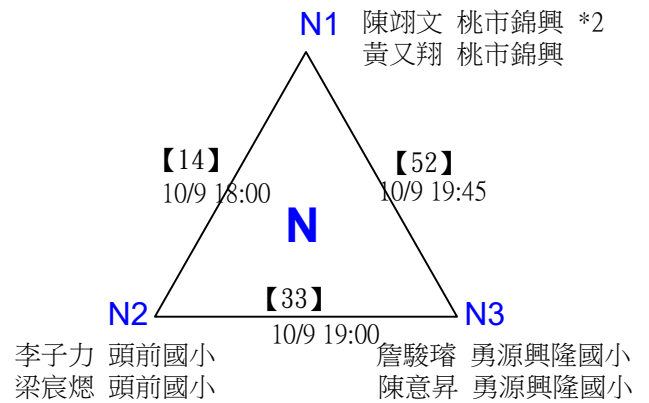
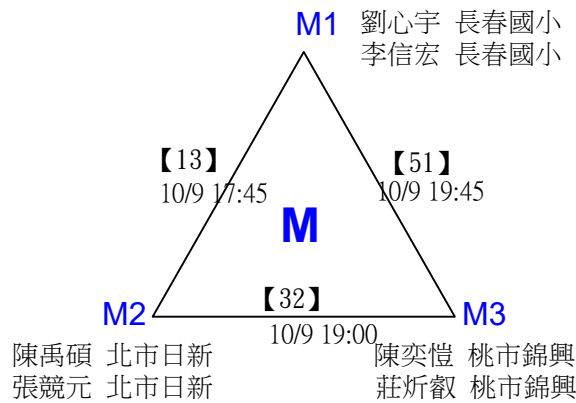
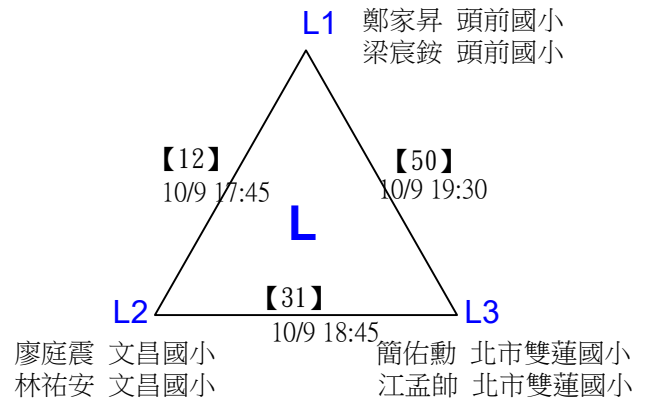
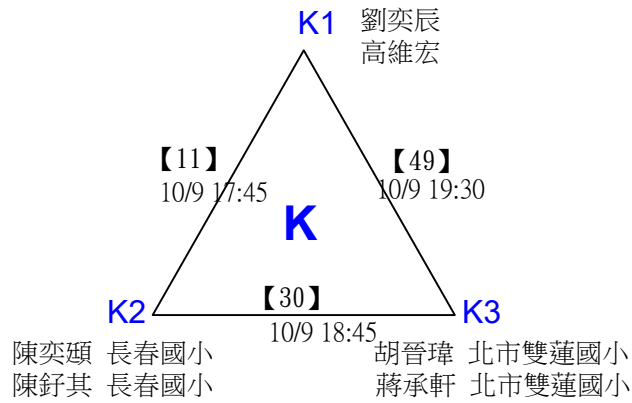
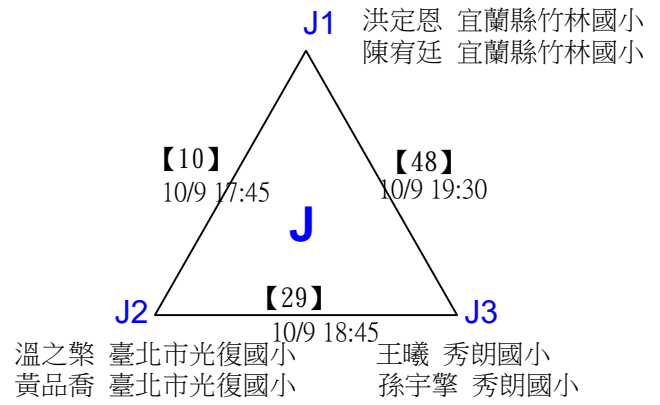
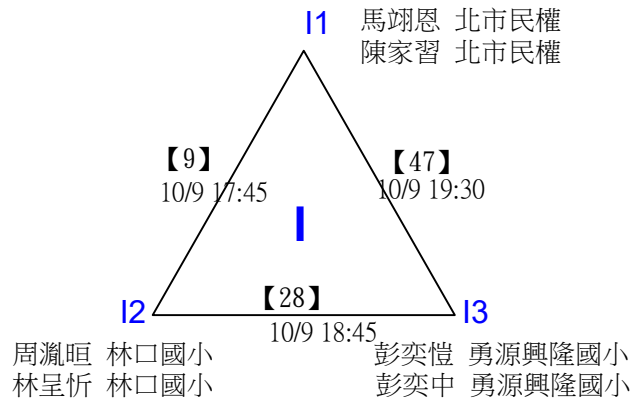

# 2023 婕斯羽你同行 國小暨親子分齡賽

國小五年級組男雙 共53籤

取8名

王睿翔 台中市南屯國小      姚飛禎 北市日新  
林顯陞 台中市南屯國小      許皓雲 北市日新

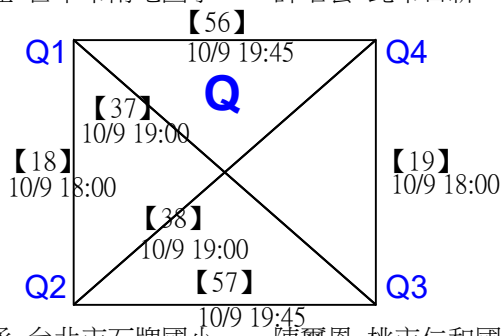

陳星丞 台北市石牌國小      陳璽恩 桃市仁和國小  
廖彥碩 台北市石牌國小      洪龍辰 桃市仁和國小

# 2023 婕斯羽你同行 國小暨親子分齡賽

取8名

國小五年級組男雙

決賽：三角取一，四角取二，抽籤決定位置。

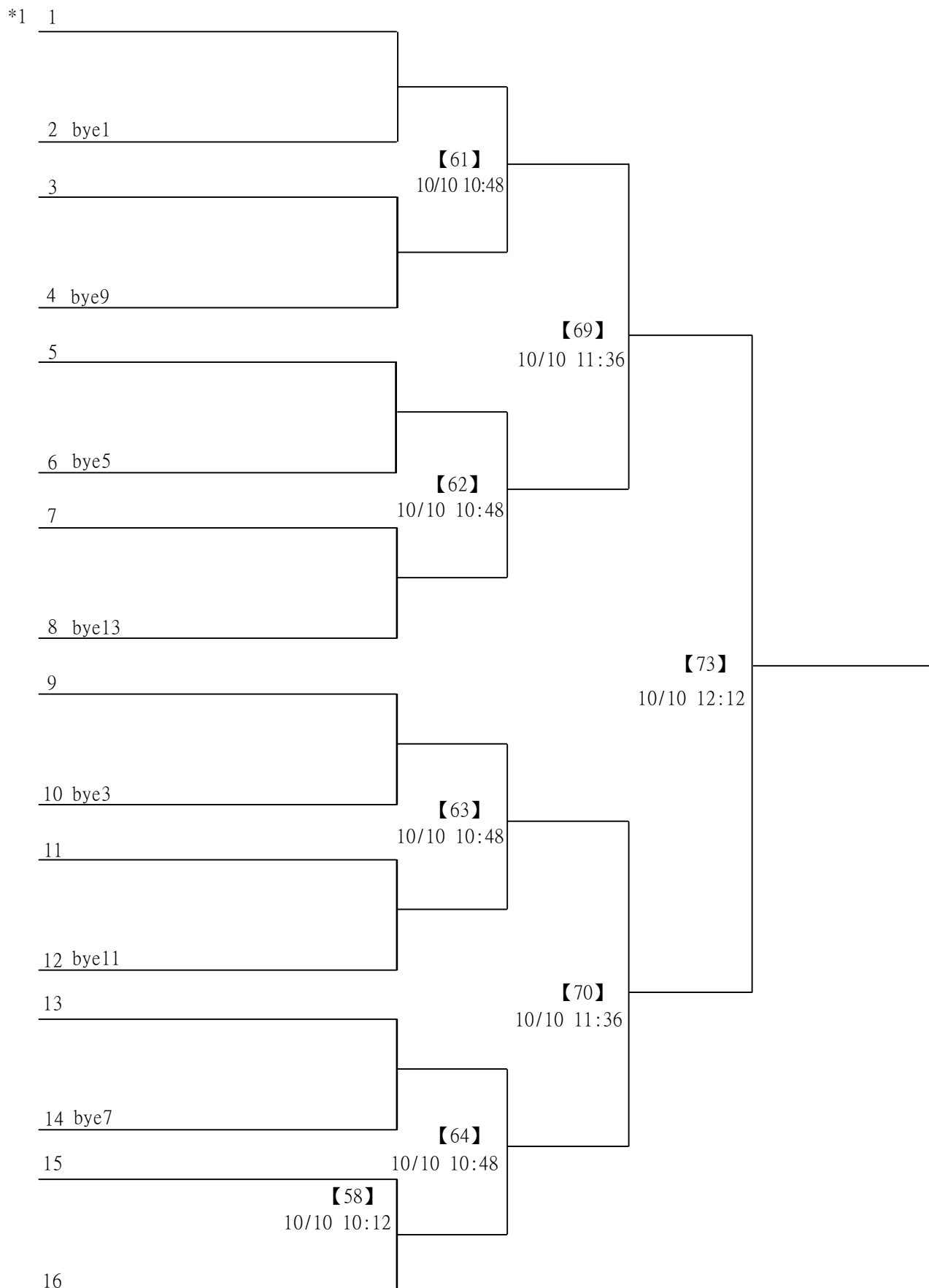

# 2023 婕斯羽你同行 國小暨親子分齡賽

取8名

國小五年級組男雙

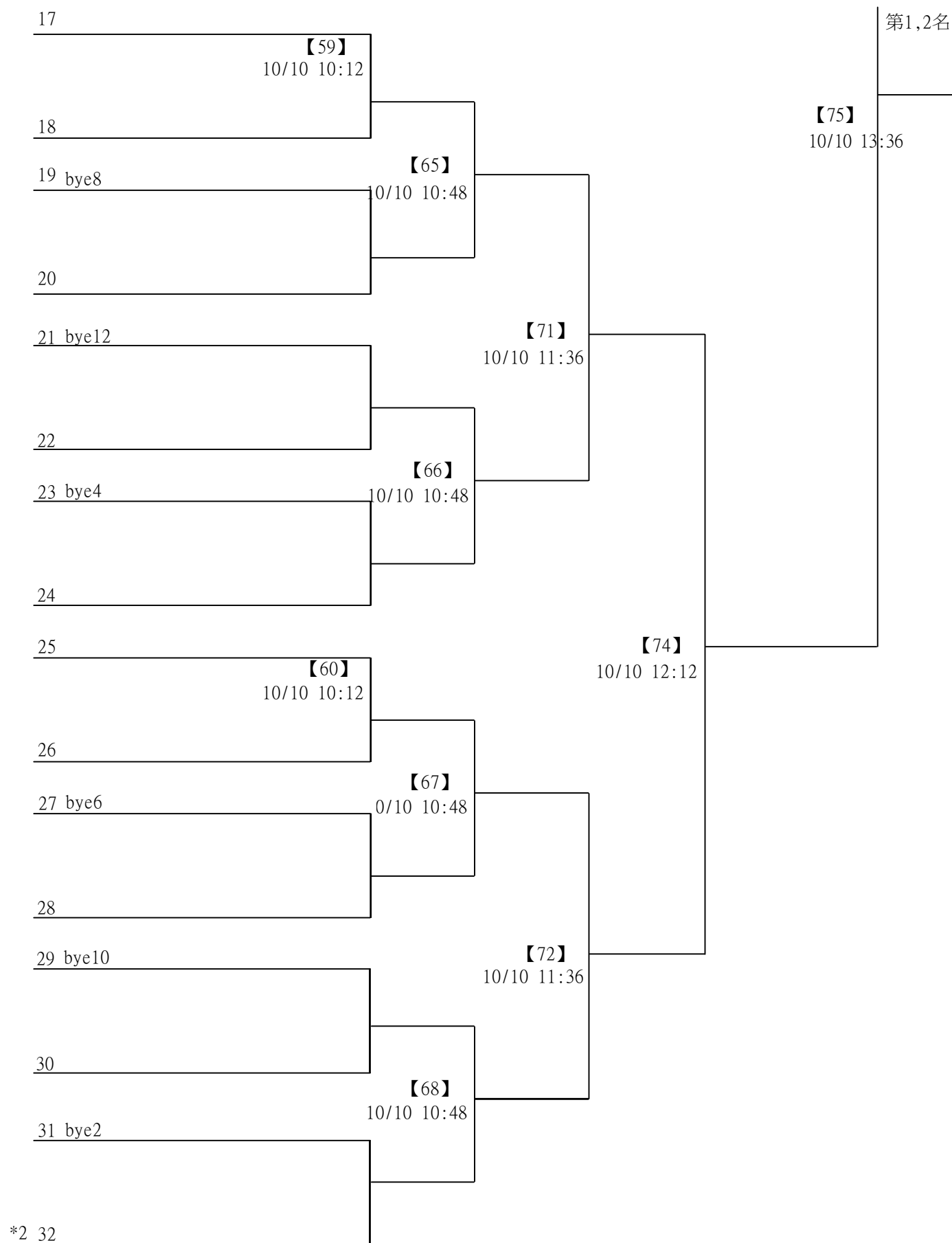

# 2023婕斯羽你同行國小暨親子分齡賽

取4名

國小六年級組女雙 共28籤

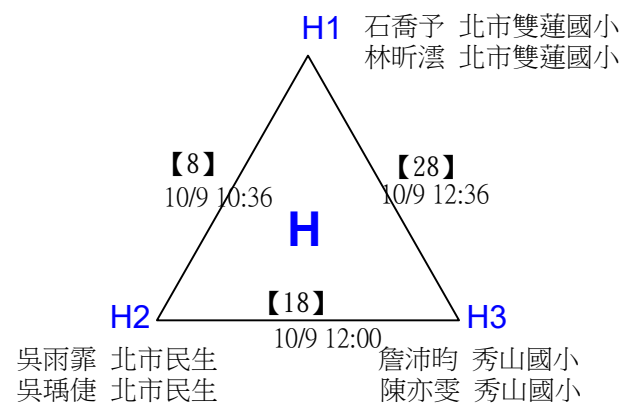
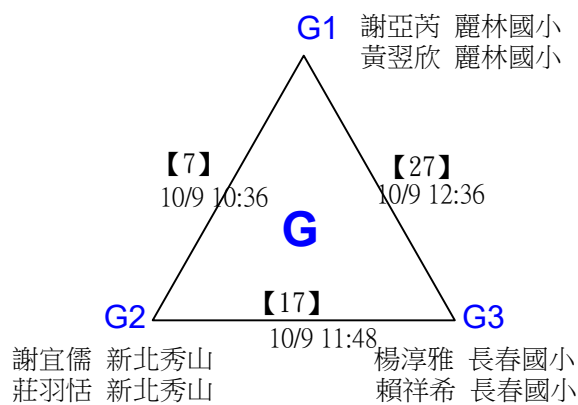
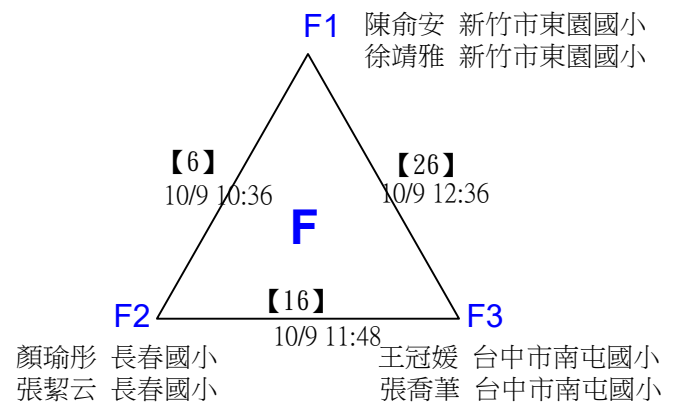
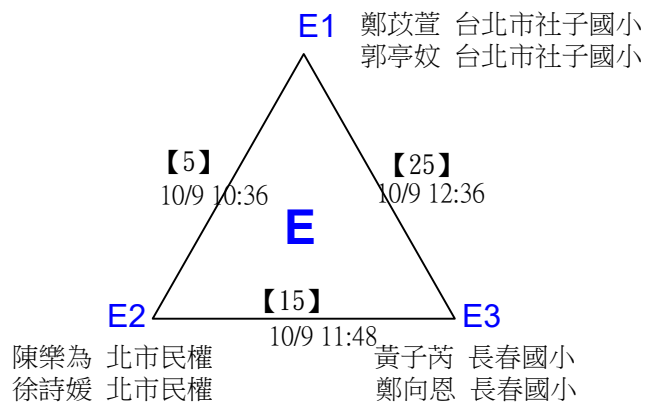
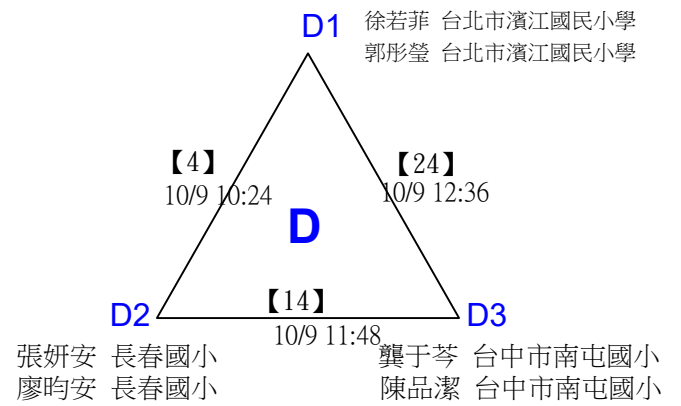
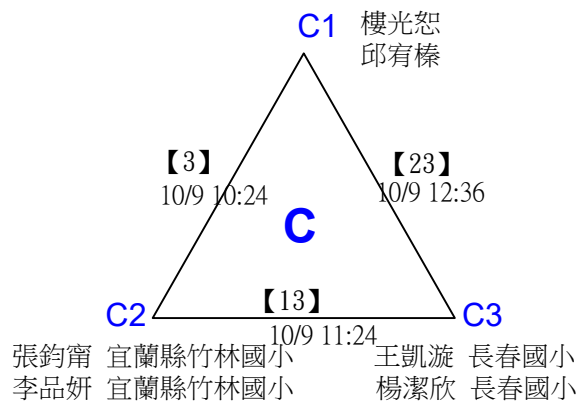
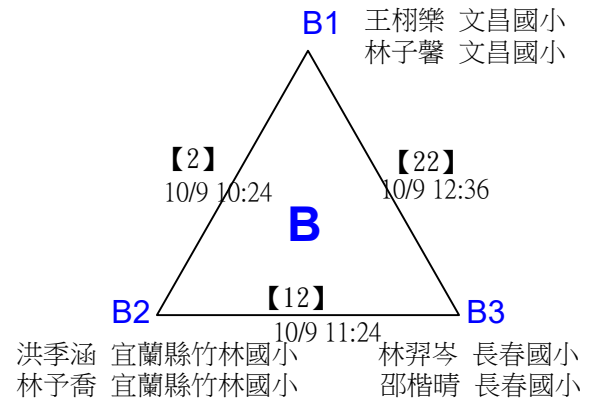
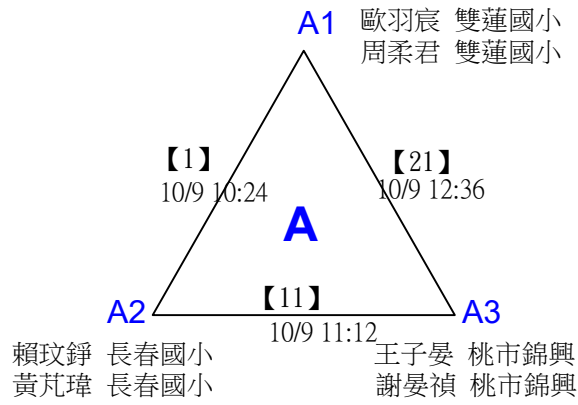

# 2023婕斯羽你同行國小暨親子分齡賽

國小六年級組女雙 共28籤

取4名

曾奕瑄 林口國小      萬艾玲 勇源興隆國小  
 吳宥潔 林口國小      郭芸綺 勇源興隆國小

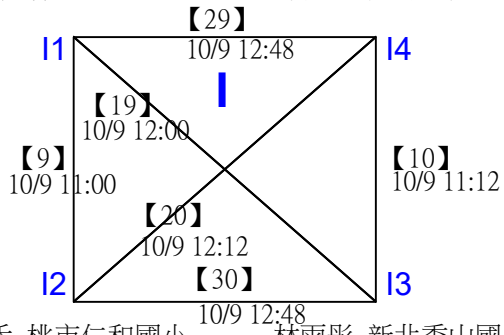

陳雨禾 桃市仁和國小      林雨彤 新北秀山國小  
 黃橋喬 桃市仁和國小      林雨詩 新北秀山國小



# 2023 婕斯羽你同行 國小暨親子分齡賽

取4名

國小六年級組女雙

決賽：三角取一，四角取二，抽籤決定位置。

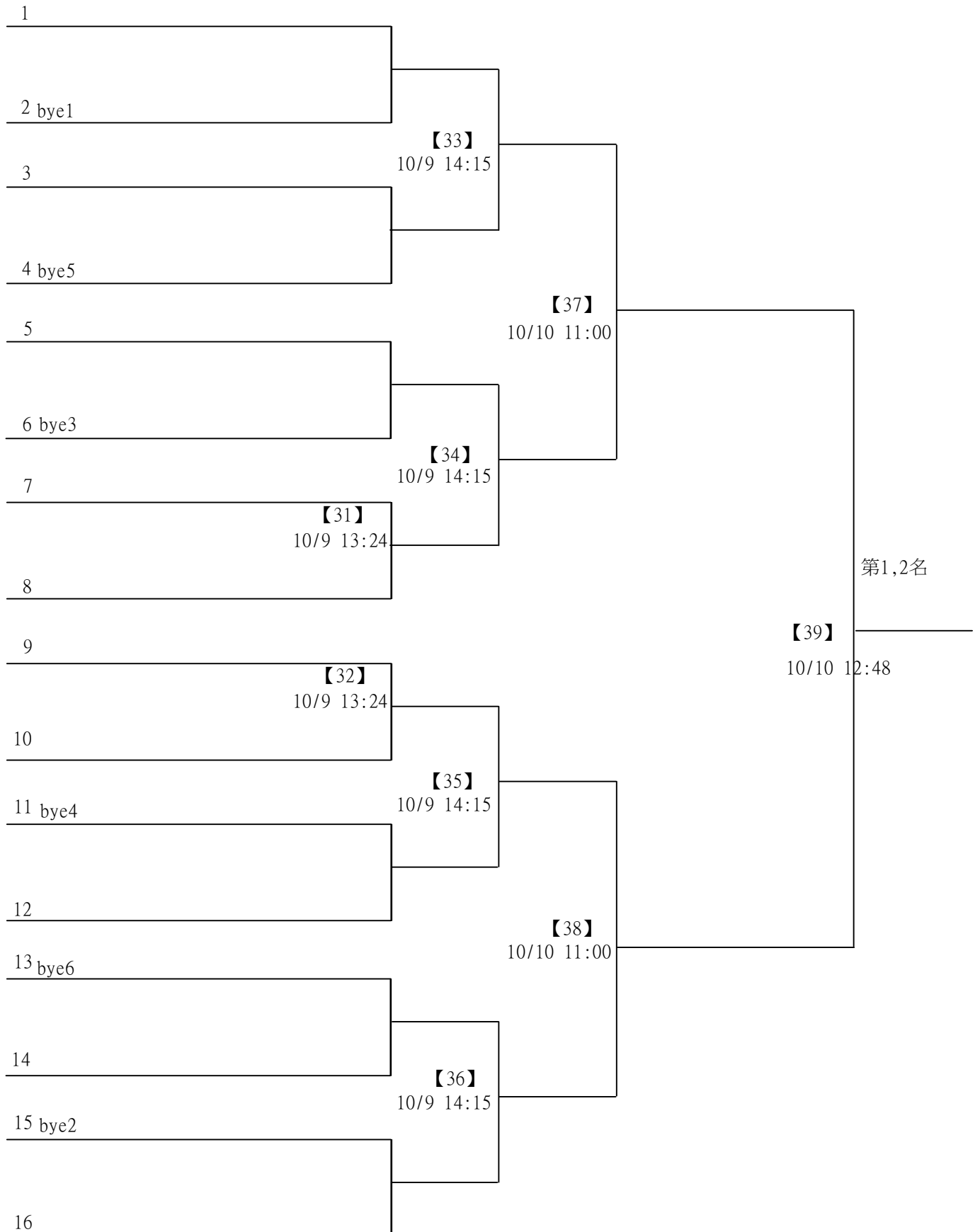

# 2023婕斯羽你同行國小暨親子分齡賽

取8名

國小六年級組男雙 共58籤

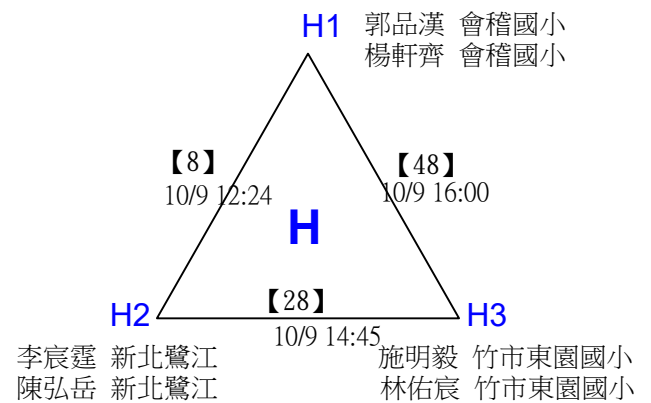
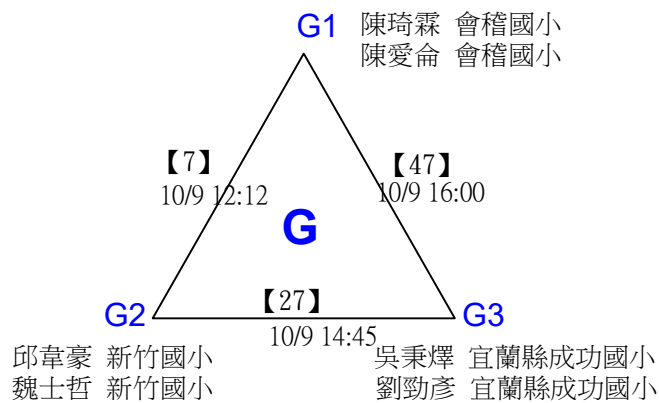
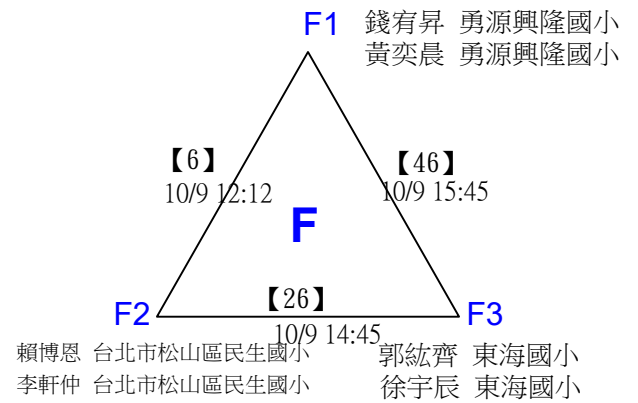
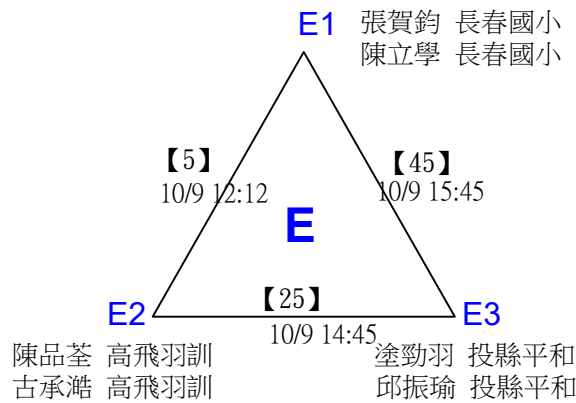
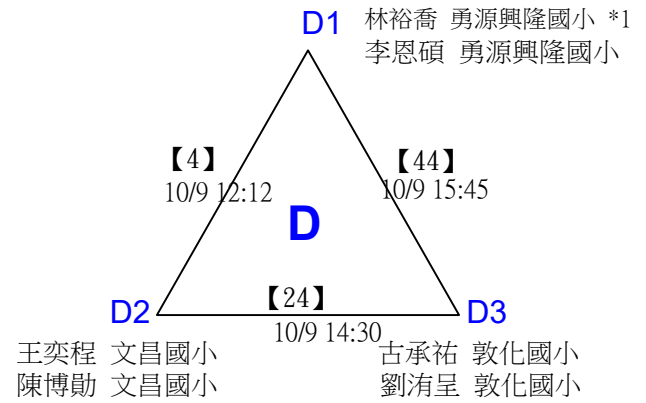
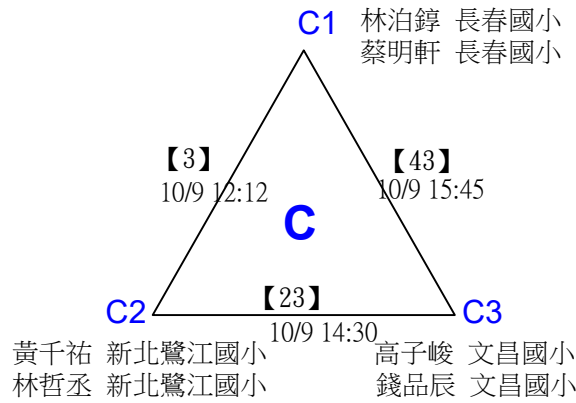
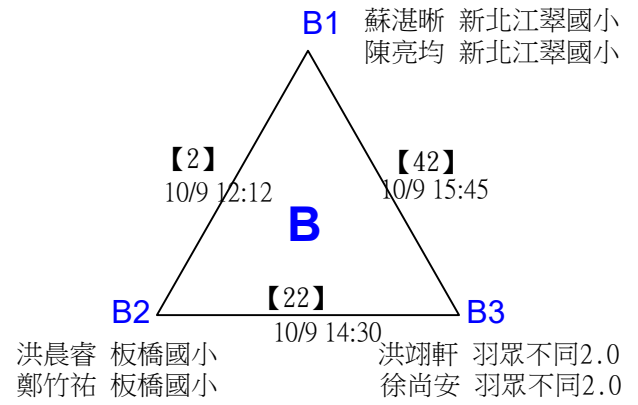
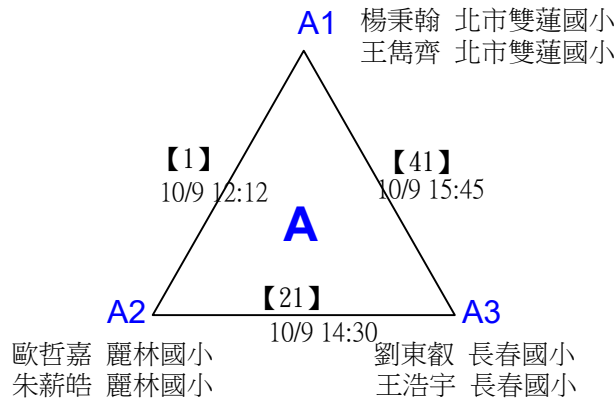

# 2023婕斯羽你同行國小暨親子分齡賽

取8名

國小六年級組男雙 共58籤

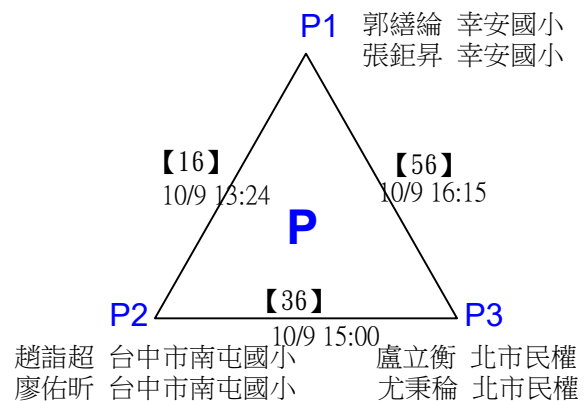
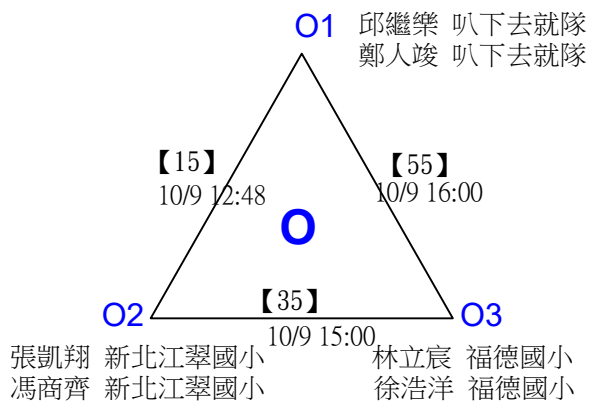
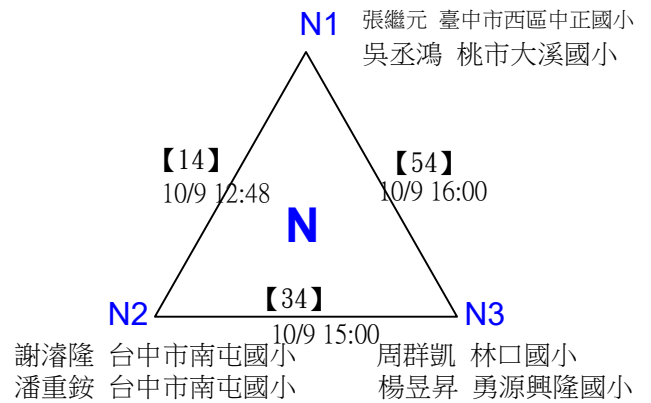
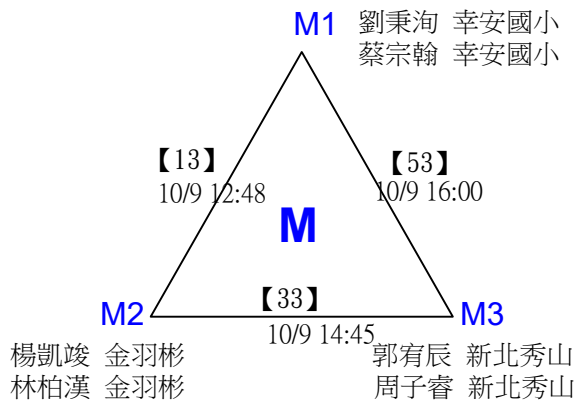
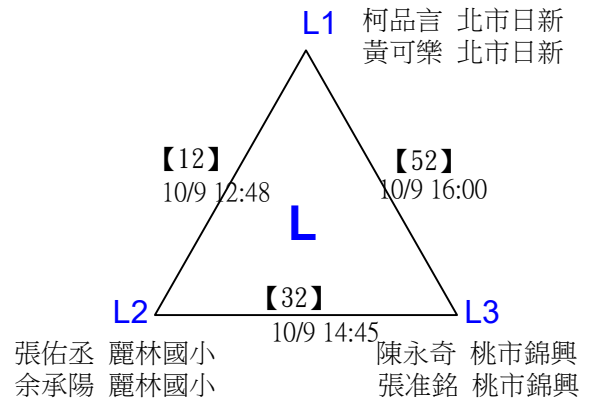
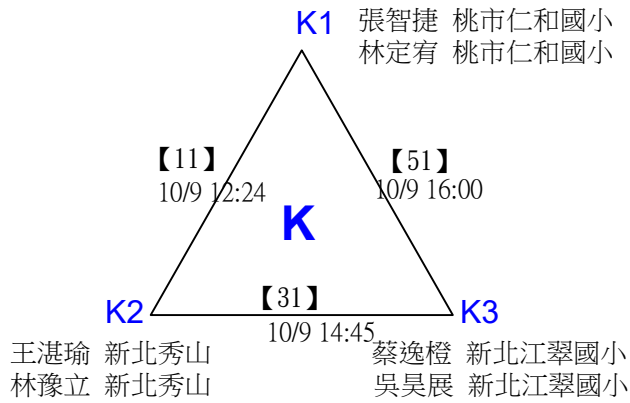
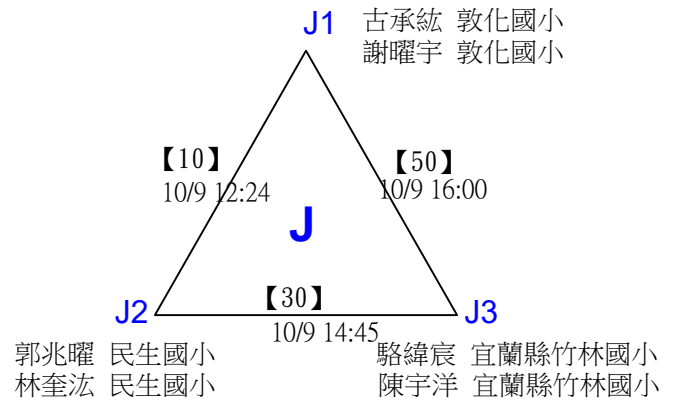
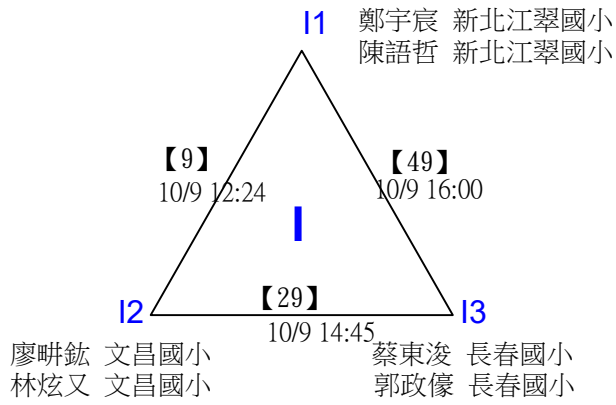

# 2023婕斯羽你同行國小暨親子分齡賽

取8名

國小六年級組男雙 共58籤

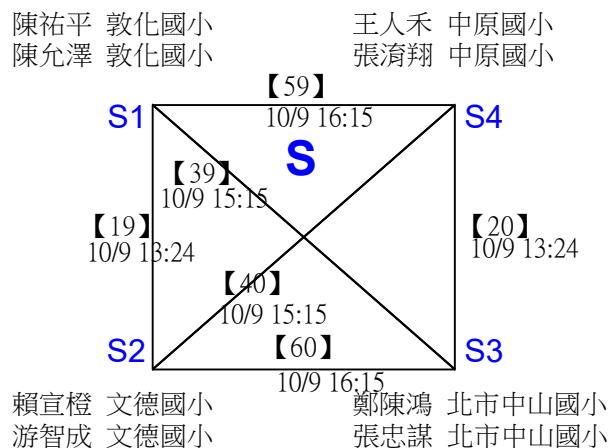
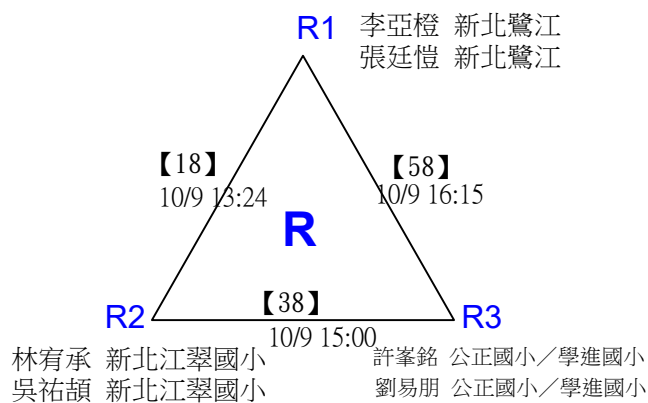
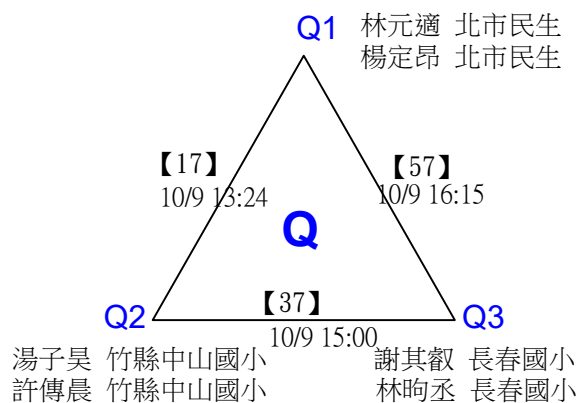

# 2023 婕斯羽你同行 國小暨親子分齡賽

取8名

國小六年級組男雙

決賽：三角取一，四角取二，抽籤決定位置。

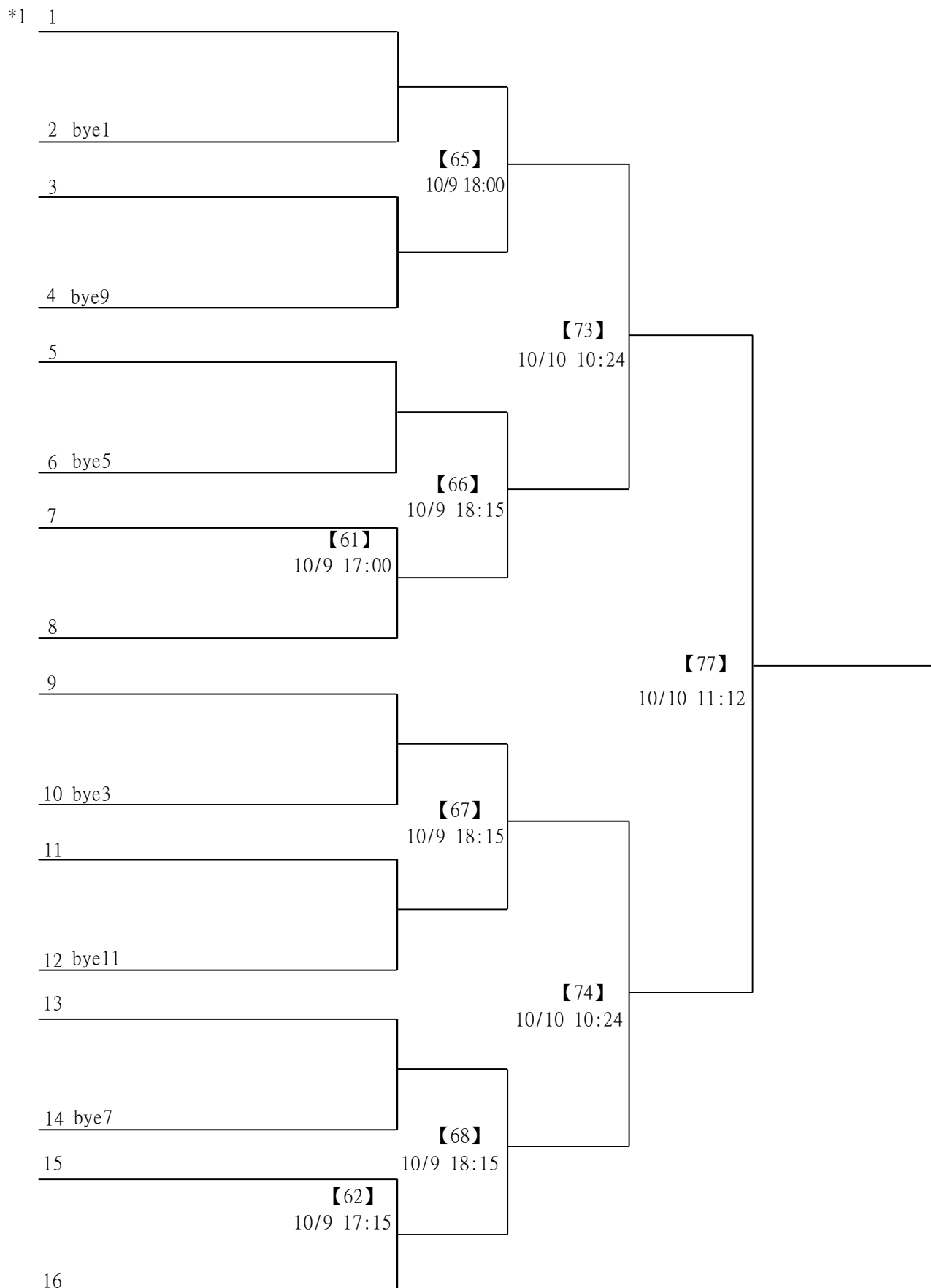

# 2023 婕斯羽你同行 國小暨親子分齡賽

取8名

國小六年級組男雙

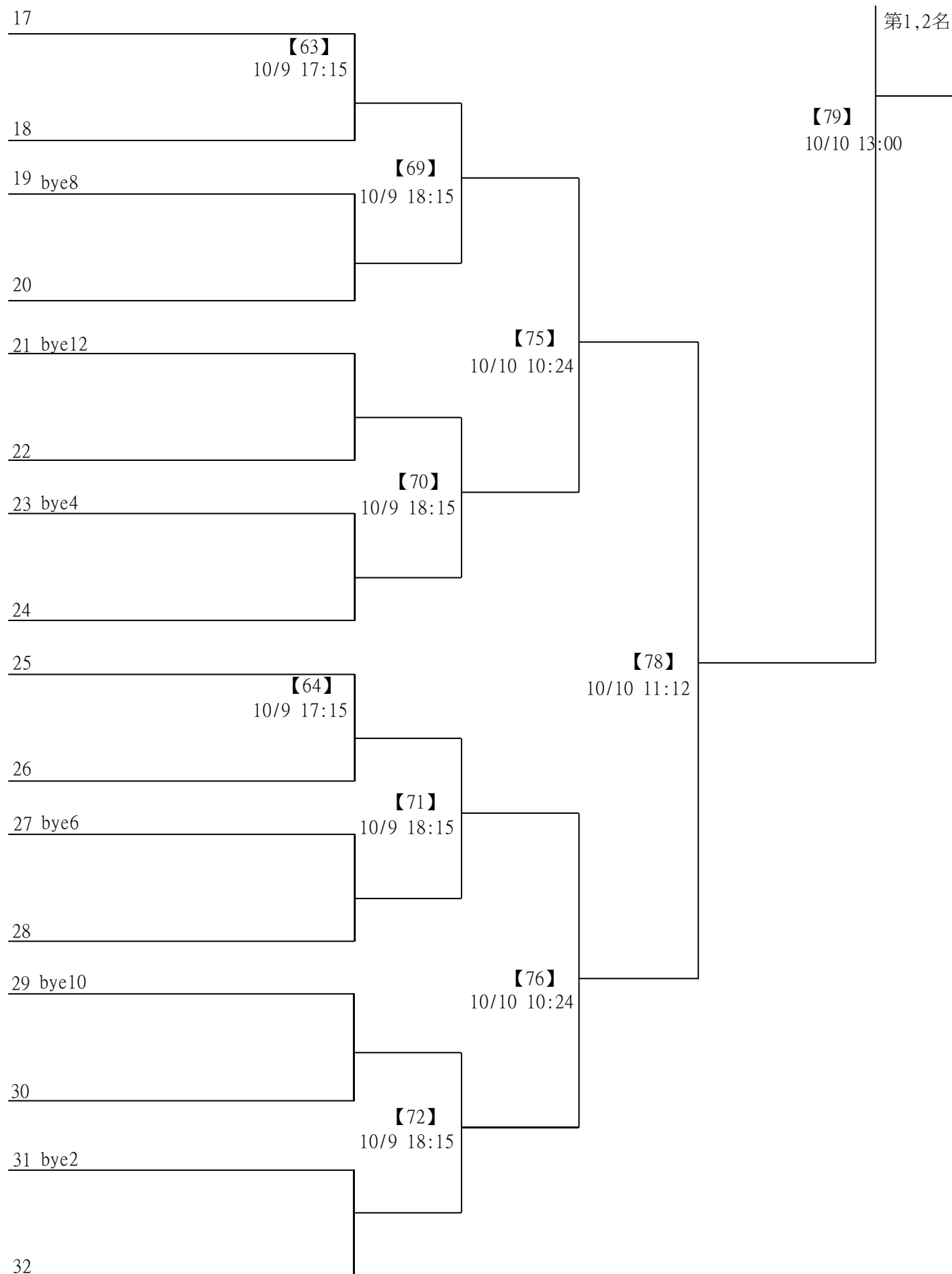

# 2023婕斯羽你同行國小暨親子分齡賽

取2名

國小低年級組母子女雙打 共9籤

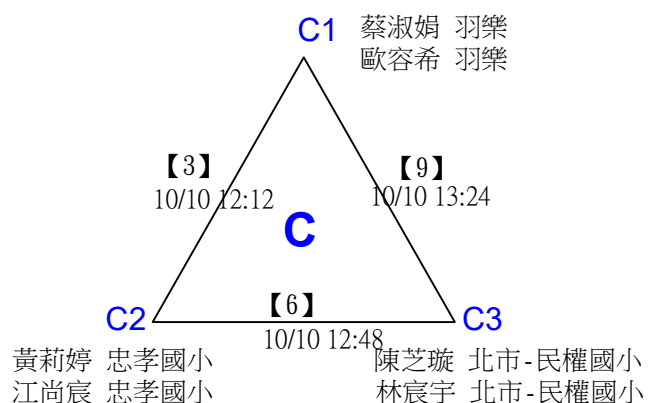
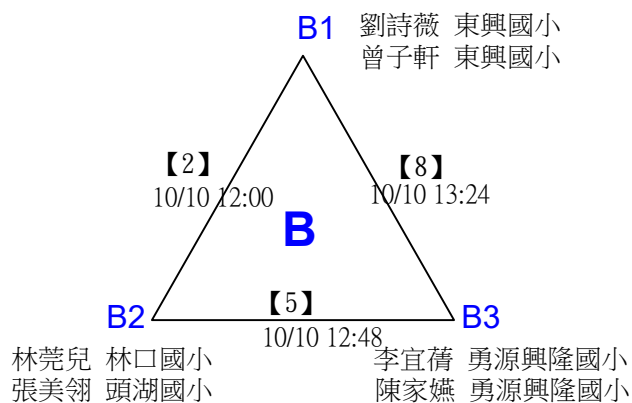
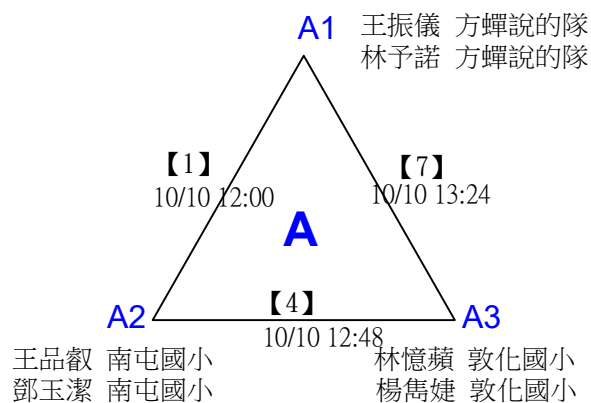

# 2023 婕斯羽你同行 國小暨親子分齡賽

取2名

國小低年級組母子女雙打

決賽：三角取一，直接帶入。

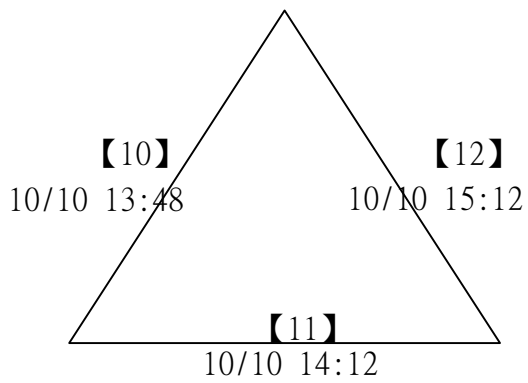



# 2023婕斯羽你同行國小暨親子分齡賽

取2名

國小低年級組父女雙打 共9籤

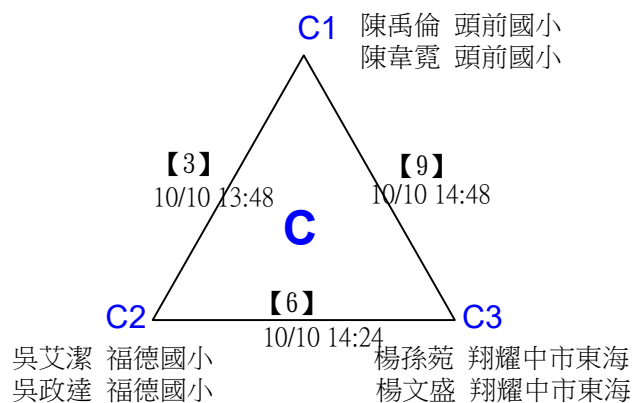
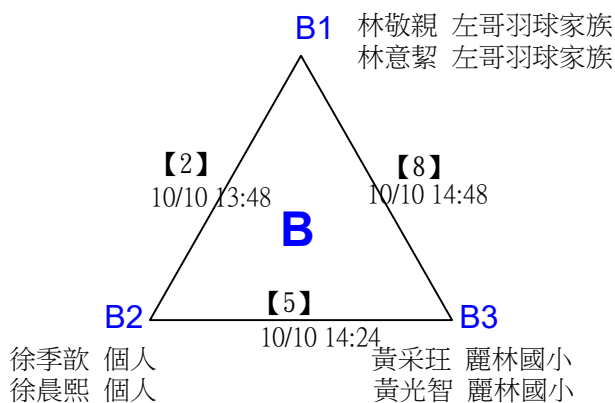
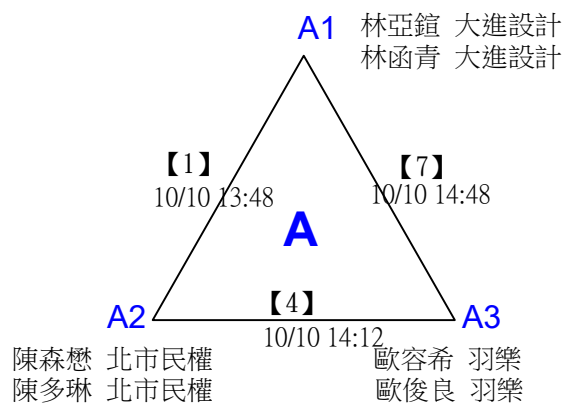

# 2023 婕斯羽你同行 國小暨親子分齡賽

取2名

國小低年級組 父女雙打

決賽：三角取一，直接帶入。

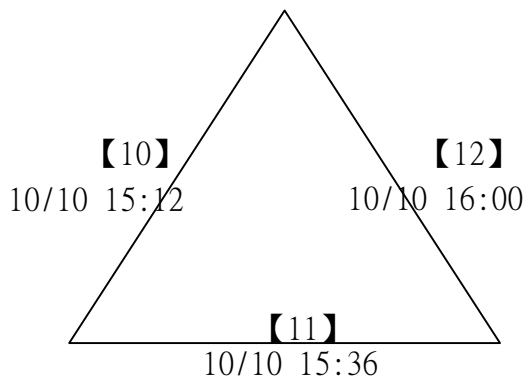

# 2023捷斯羽你同行國小暨親子分齡賽

取4名

國小低年級組父子雙打 共16籤

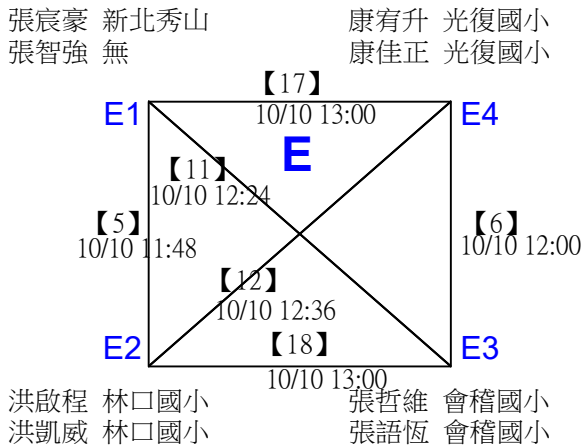
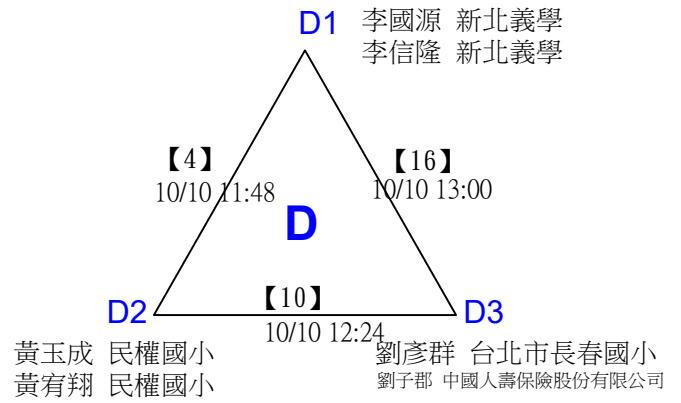
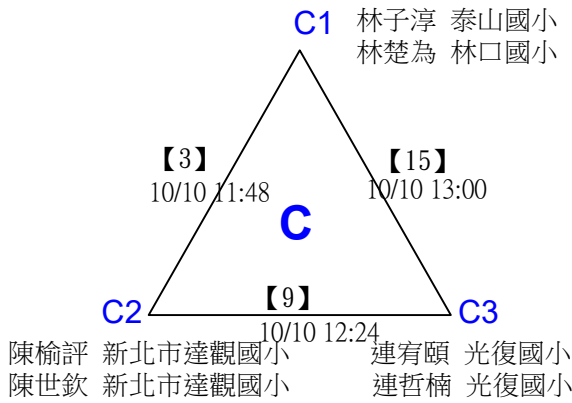
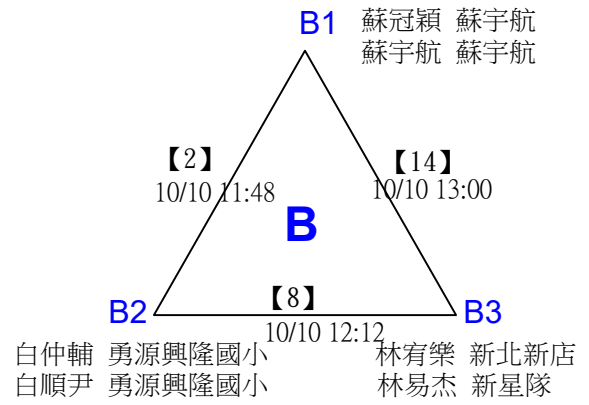
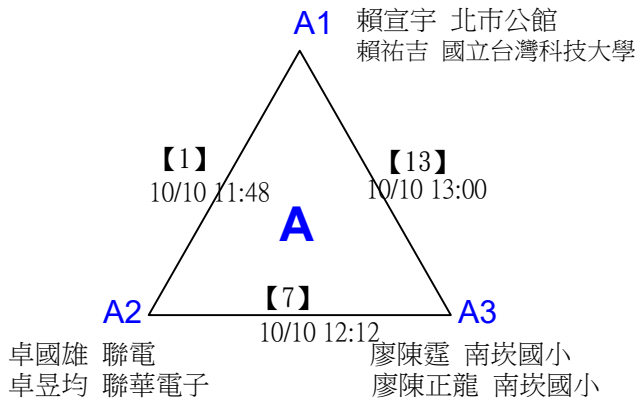

# 2023 婕斯羽你同行 國小暨親子分齡賽

取4名

國小低年級組父子雙打

決賽：三角取一，四角取二，抽籤決定位置。

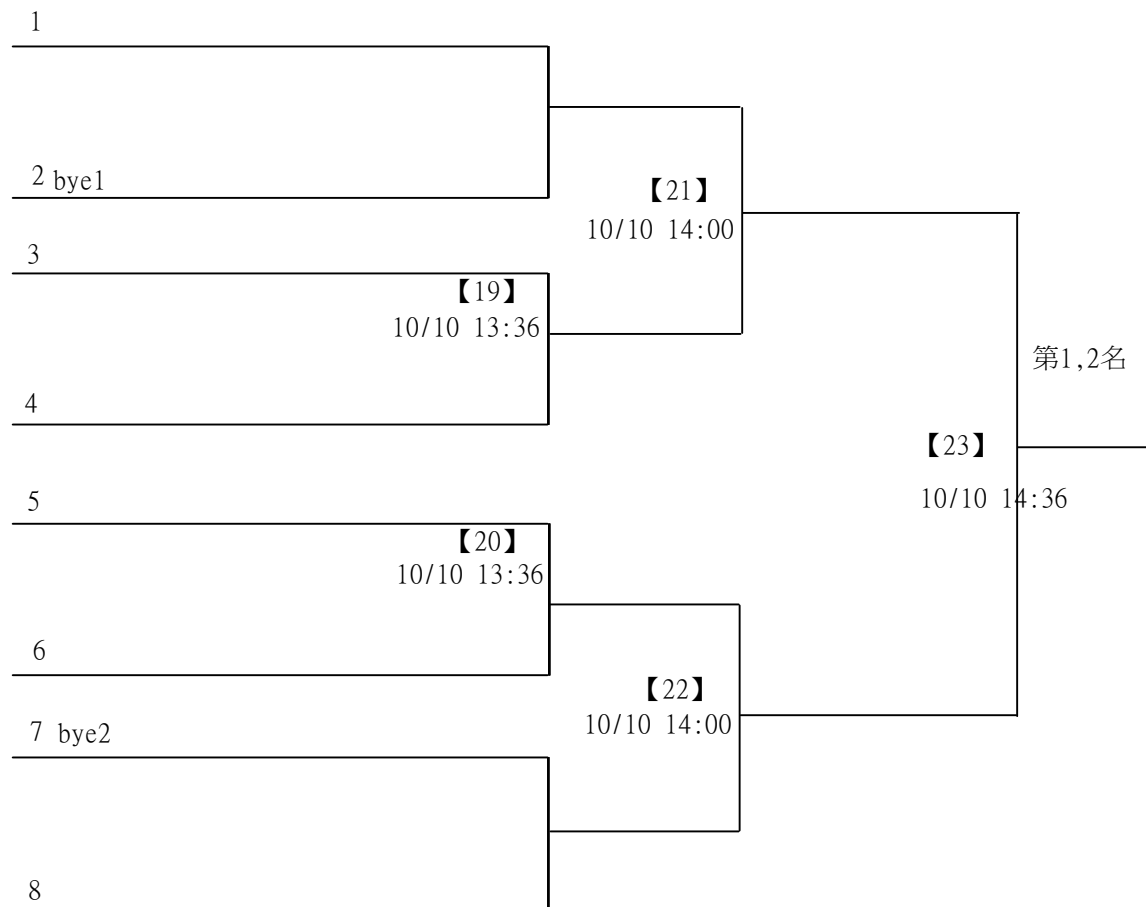

# 2023婕斯羽你同行國小暨親子分齡賽

取2名

國小中年級組母女雙打 共9籤

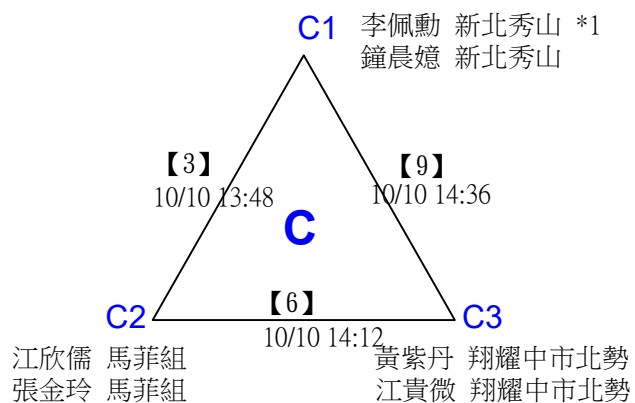
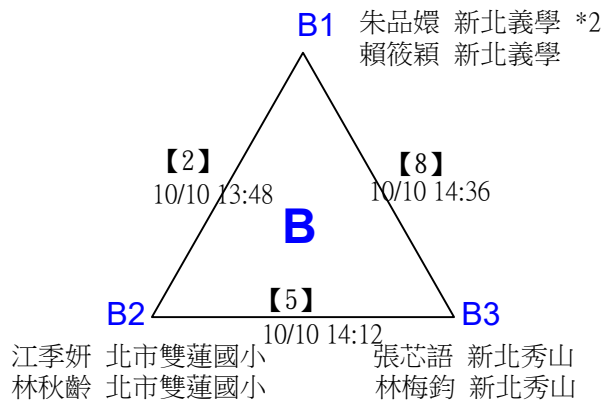
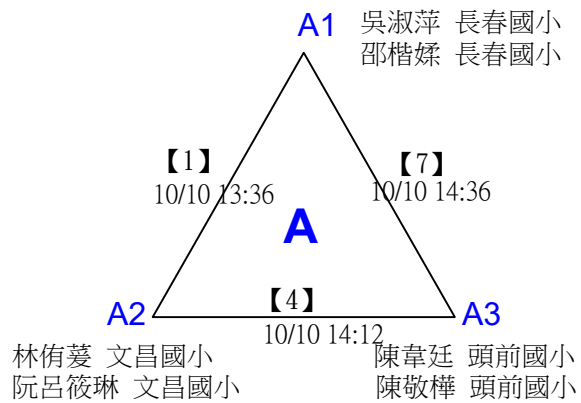

# 2023 婕斯羽你同行 國小暨親子分齡賽

取2名

國小中年級組 母女雙打

決賽：三角取一，直接帶入。

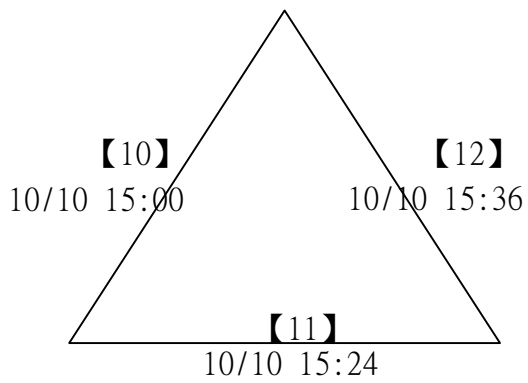

# 2023 婕斯羽你同行 國小暨親子分齡賽

取4名

國小中年級組 母子雙打 共14籤

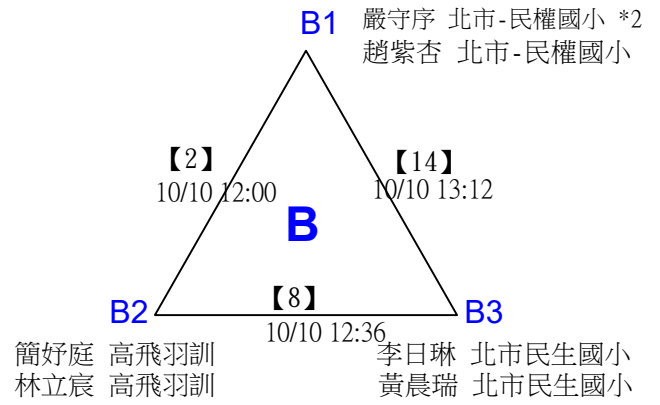
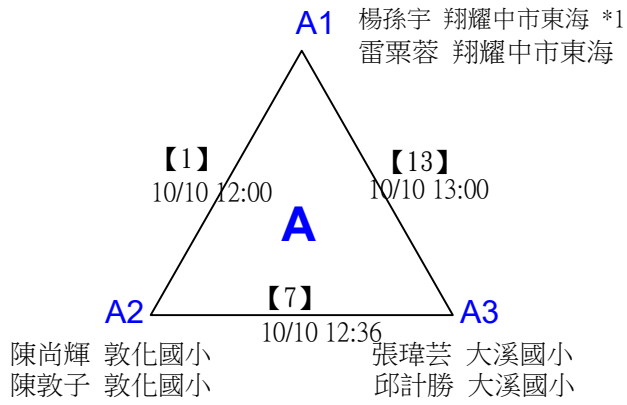

秦諒 新竹國小  
林慧芳 新竹國小

趙燕伶 敦化國小  
林睿成 敦化國小

楊廷廷 敦化國小  
蔡侑霖 敦化國小

方允成 個人  
顏名汝 個人

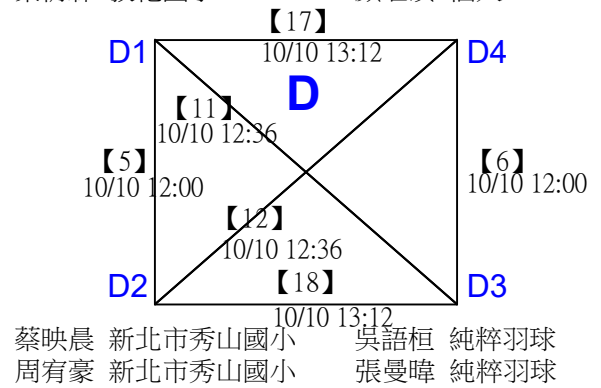
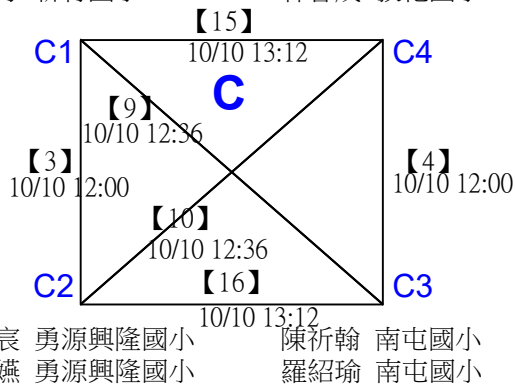

# 2023 婕斯羽你同行 國小暨親子分齡賽

取4名

國小中年級組母子雙打

決賽：三角取一，四角取二，抽籤決定位置。

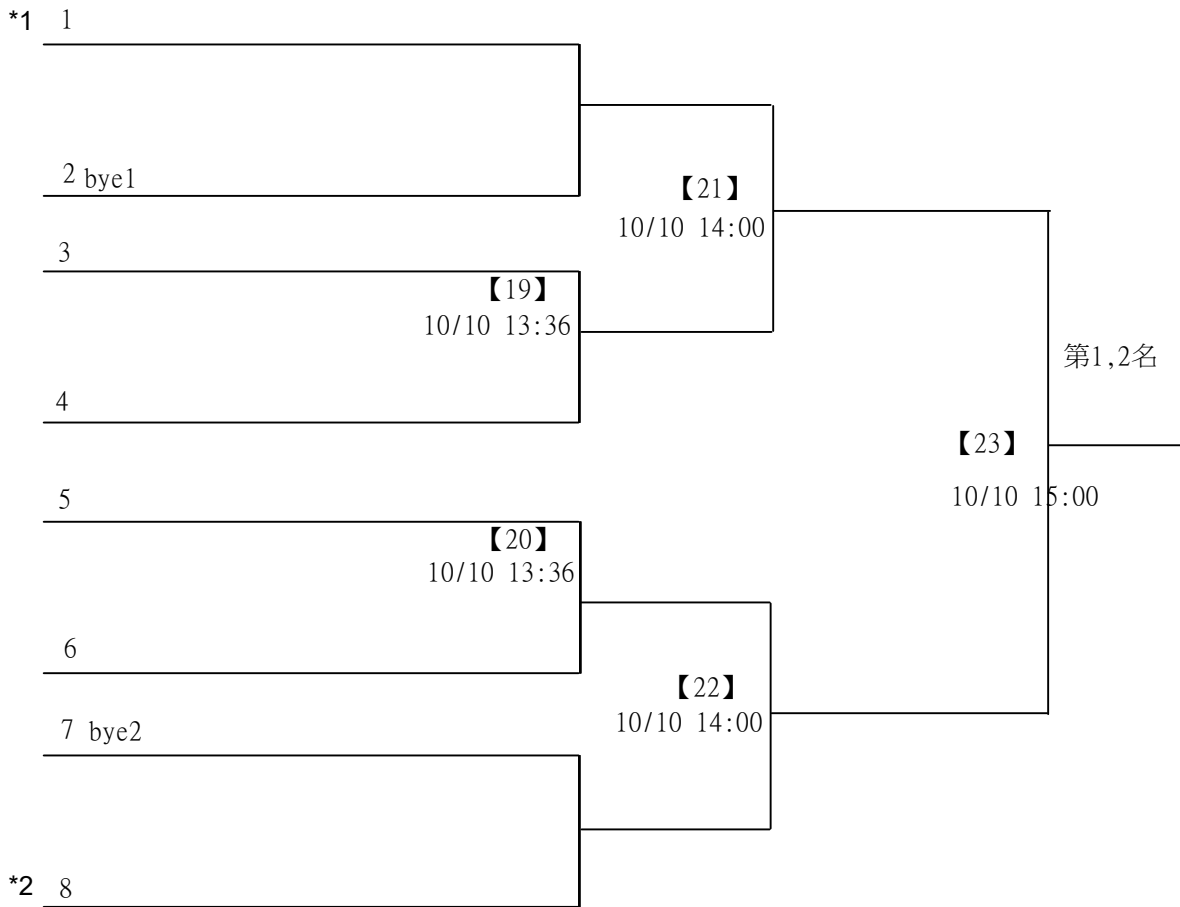



# 2023 婕斯羽你同行 國小暨親子分齡賽

取4名

國小中年級組 父女雙打 共26籤

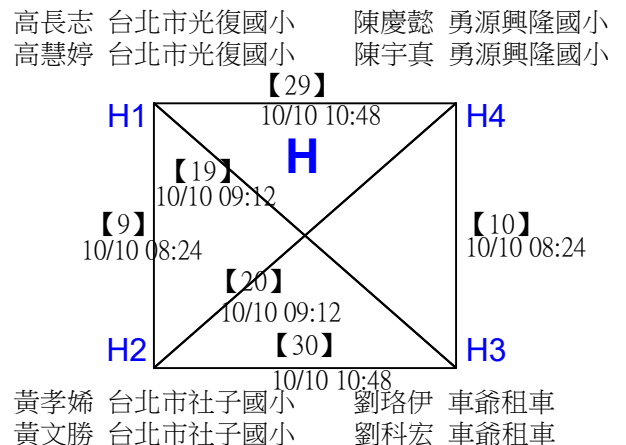
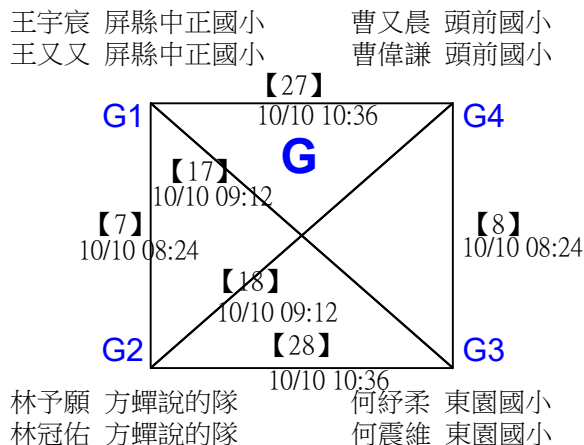
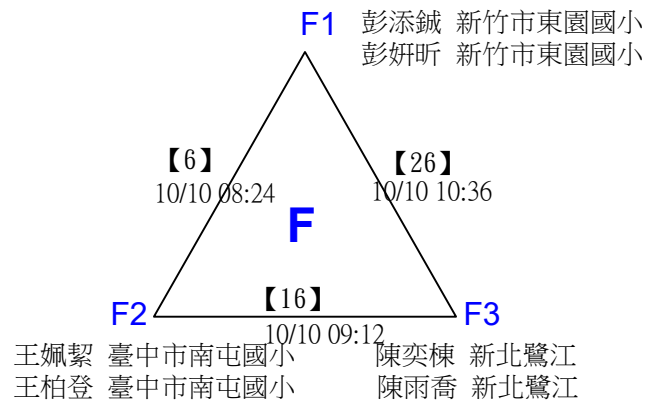
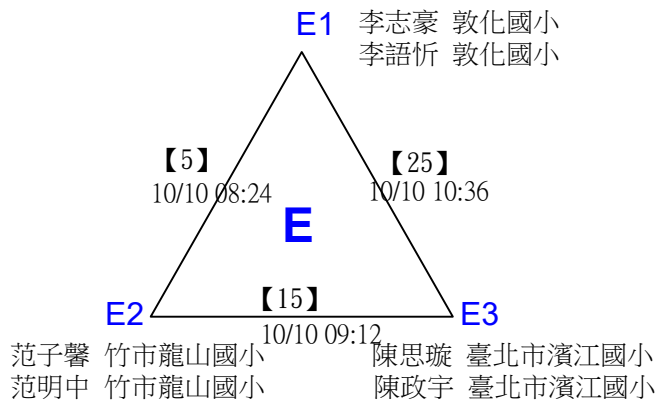
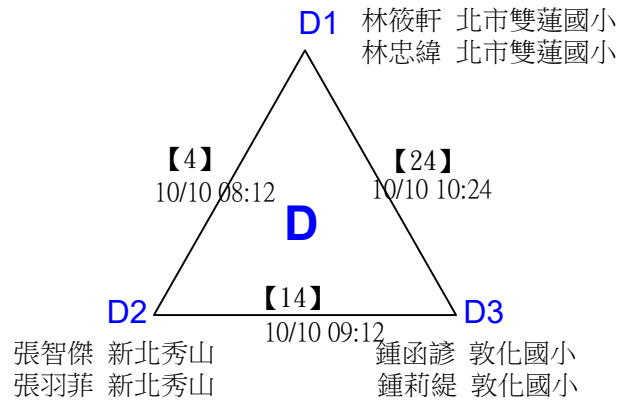
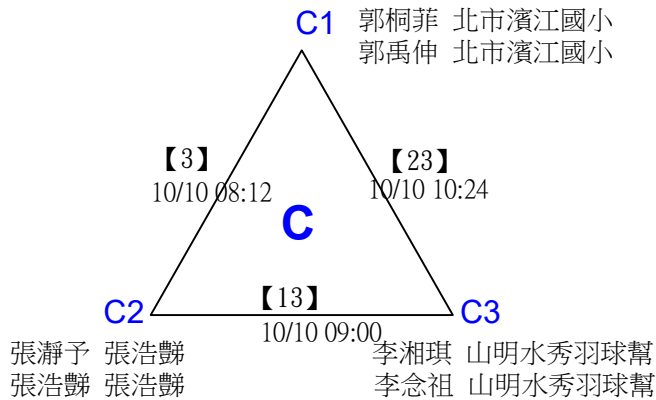
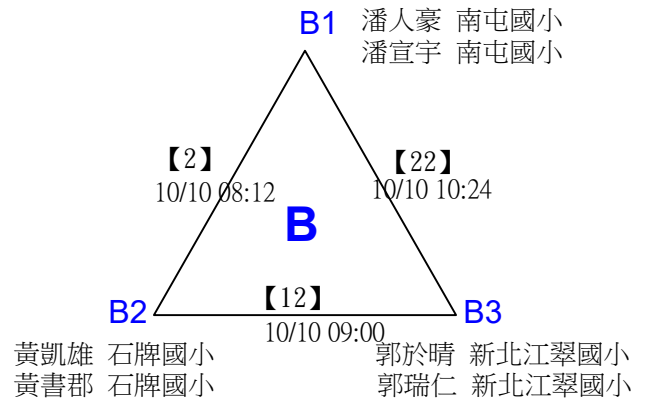
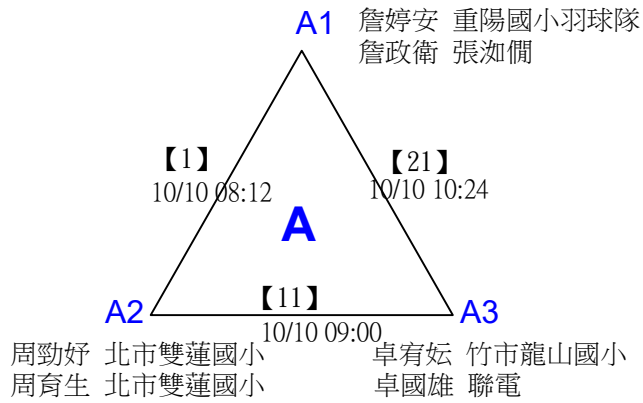

# 2023 婕斯羽你同行 國小暨親子分齡賽

取4名

國小中年級組 父女雙打

決賽：三角取一，四角取二，抽籤決定位置。

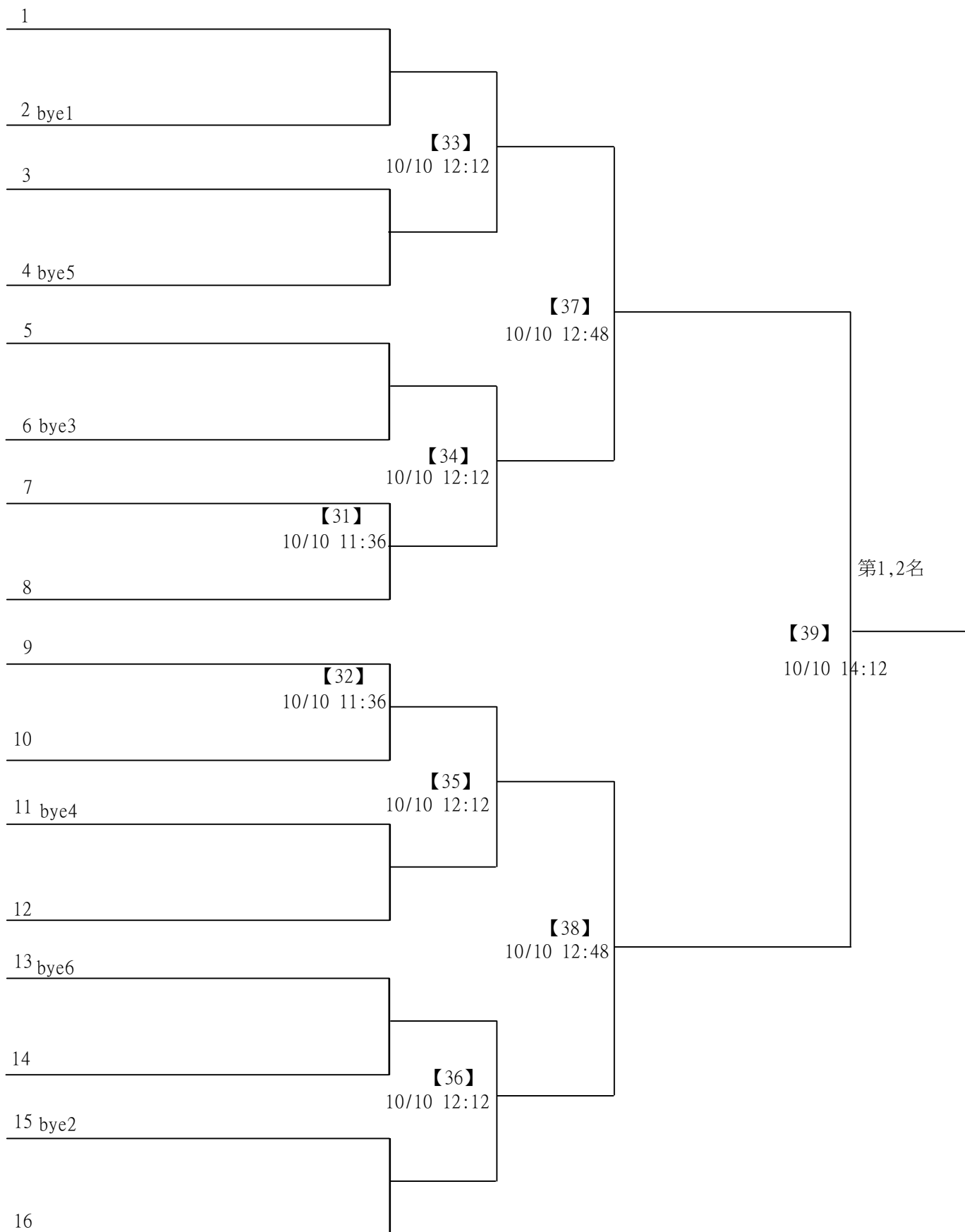

# 2023 婕斯羽你同行 國小暨親子分齡賽

取4名

國小中年級組父子雙打 共41籤

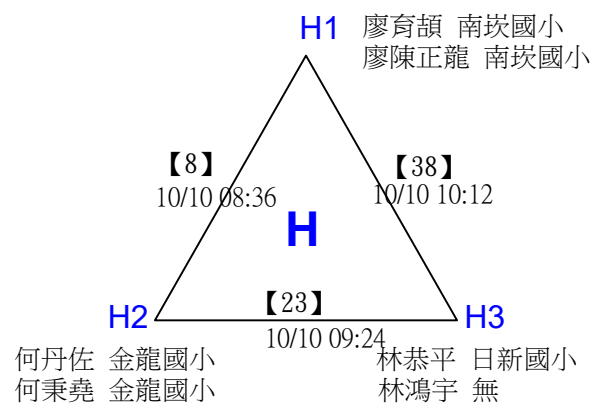
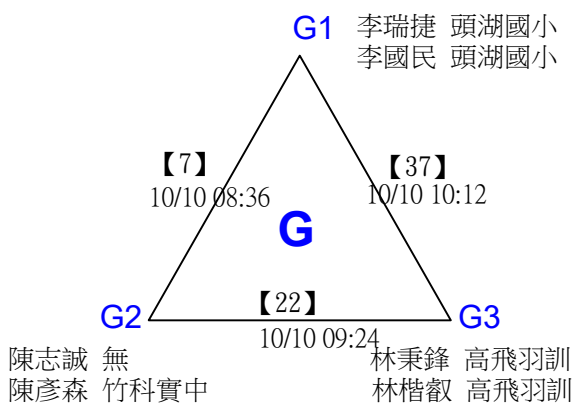
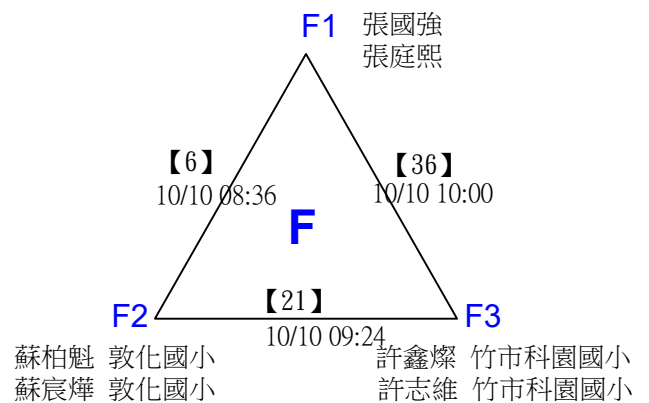
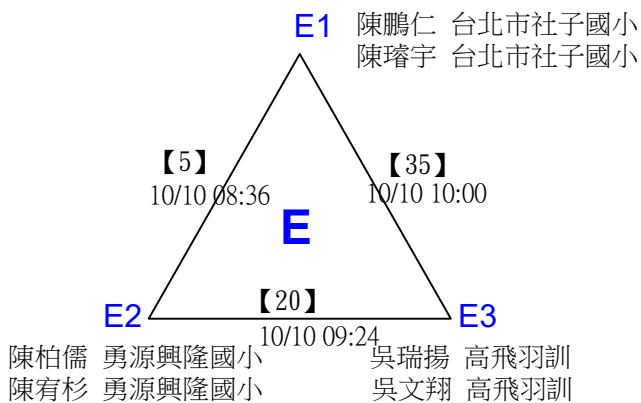
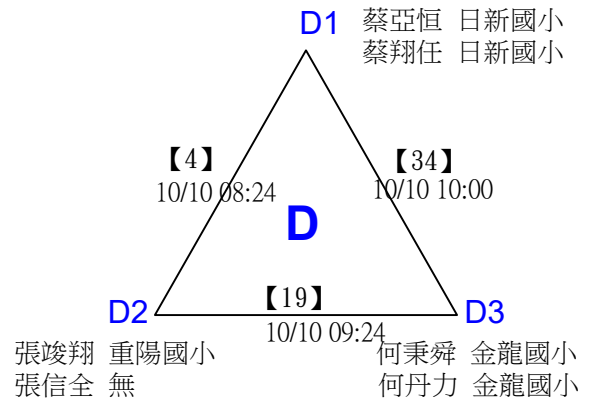
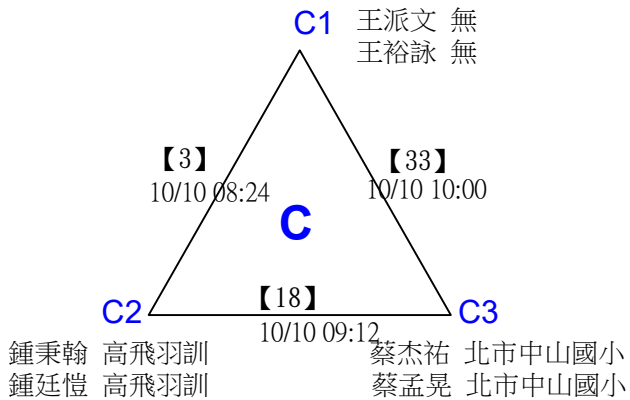
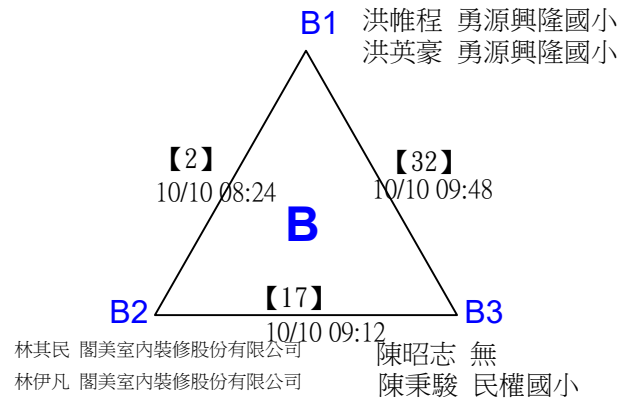
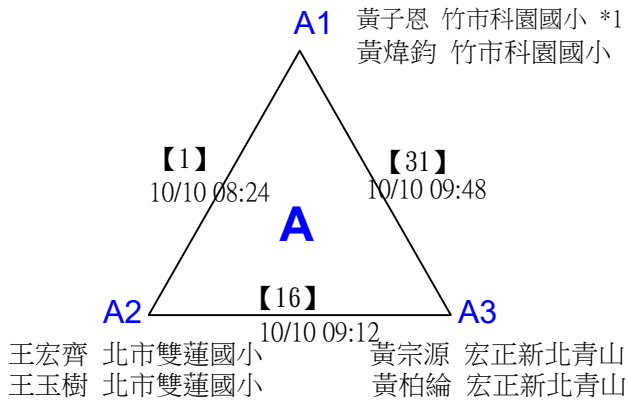

# 2023捷斯羽你同行國小暨親子分齡賽

取4名

國小中年級組父子雙打 共41籤

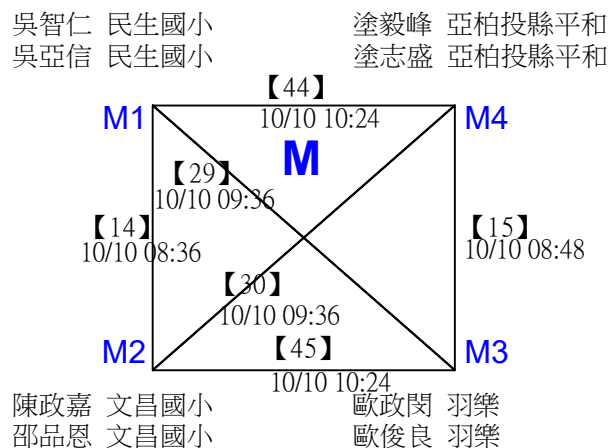
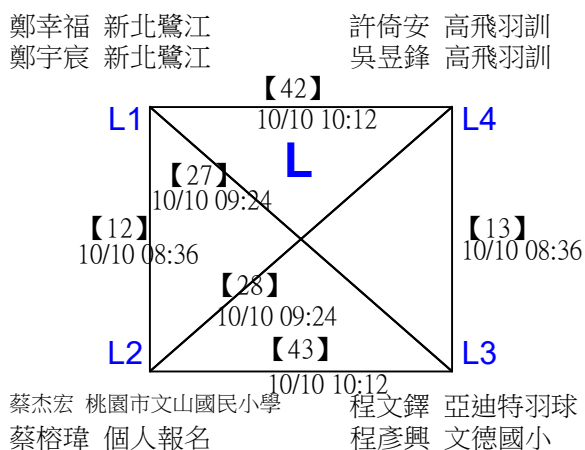
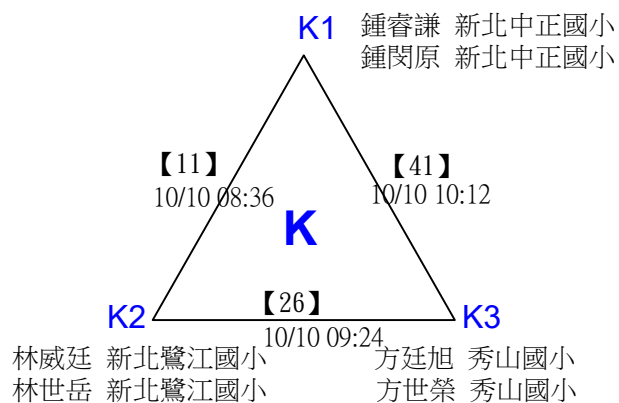
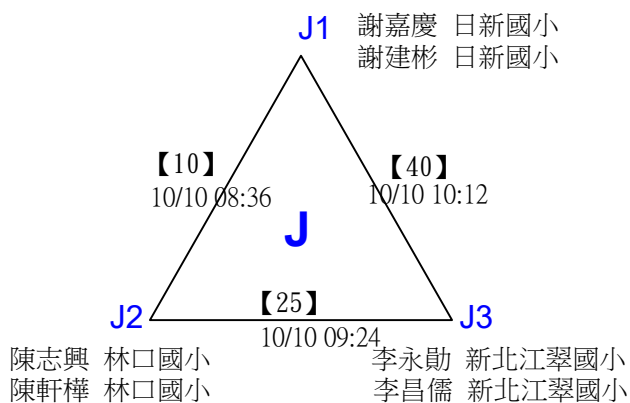
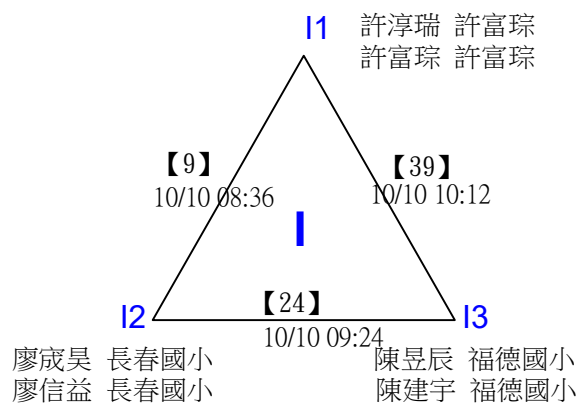

# 2023 婕斯羽你同行 國小暨親子分齡賽

取4名

國小中年級組父子雙打

決賽：三角取一，四角取二，抽籤決定位置。

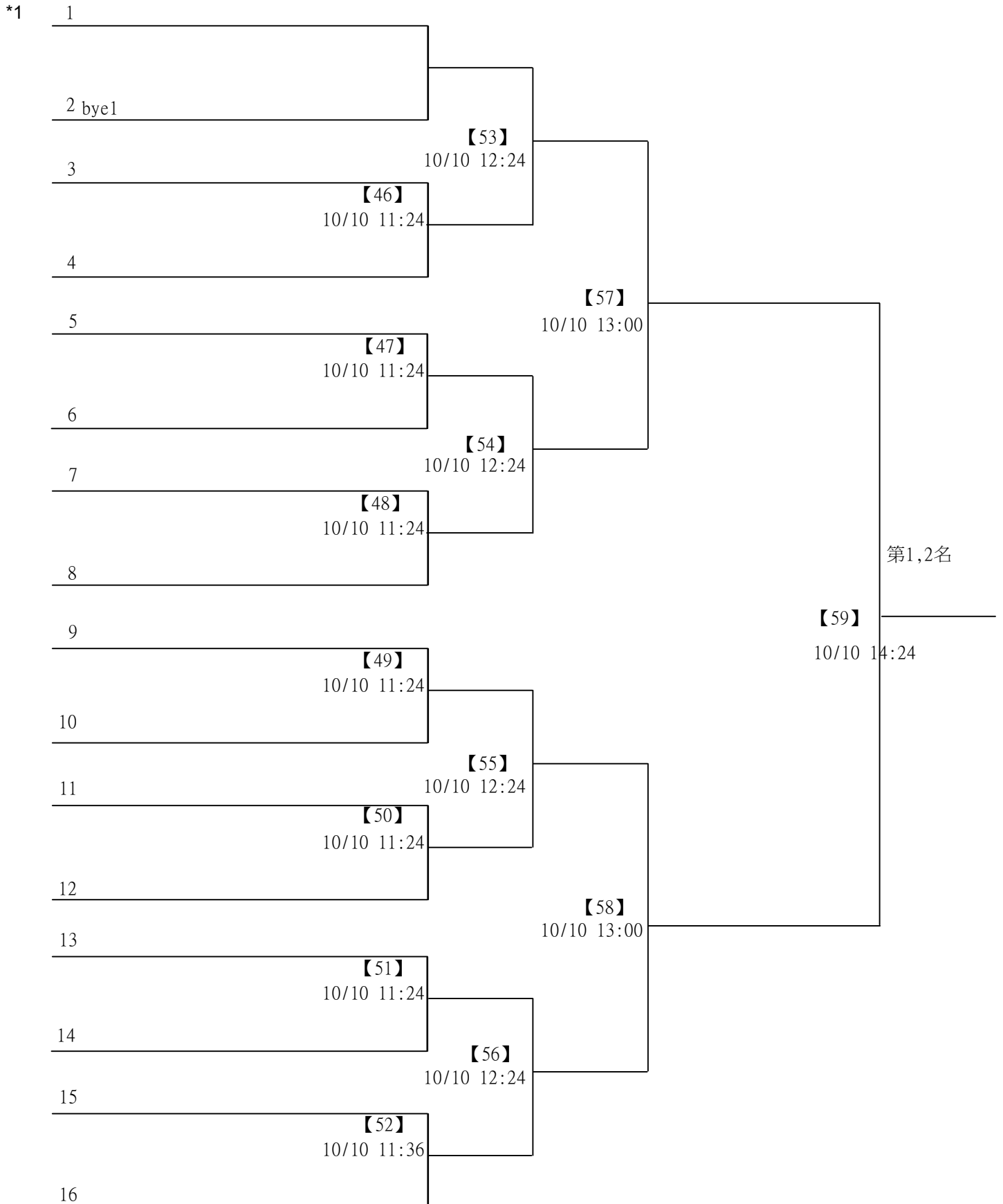

# 2023婕斯羽你同行國小暨親子分齡賽

取4名

國小高年級組母女雙打 共10籤

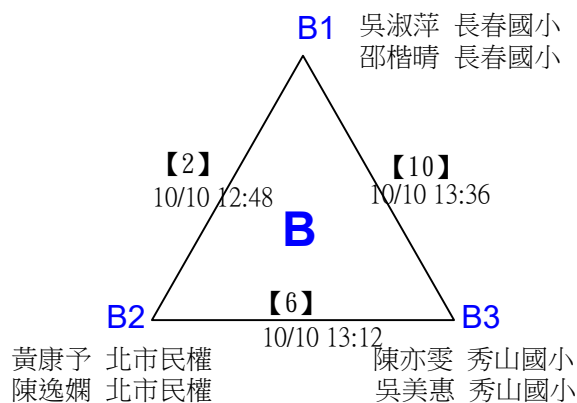
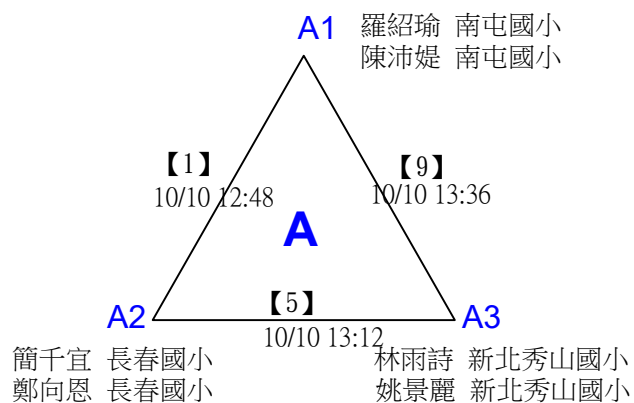

林希臻 羽林臻瘋  
羅珮菁 羽林臻瘋

黃恩慈 勇源興隆國小  
陳欣容 勇源興隆國小

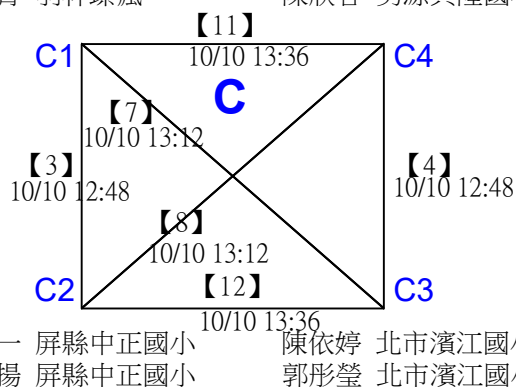

# 2023婕斯羽你同行國小暨親子分齡賽

國小高年級組母女雙打

取4名

決賽：三角取一，四角取二，抽籤決定位置。

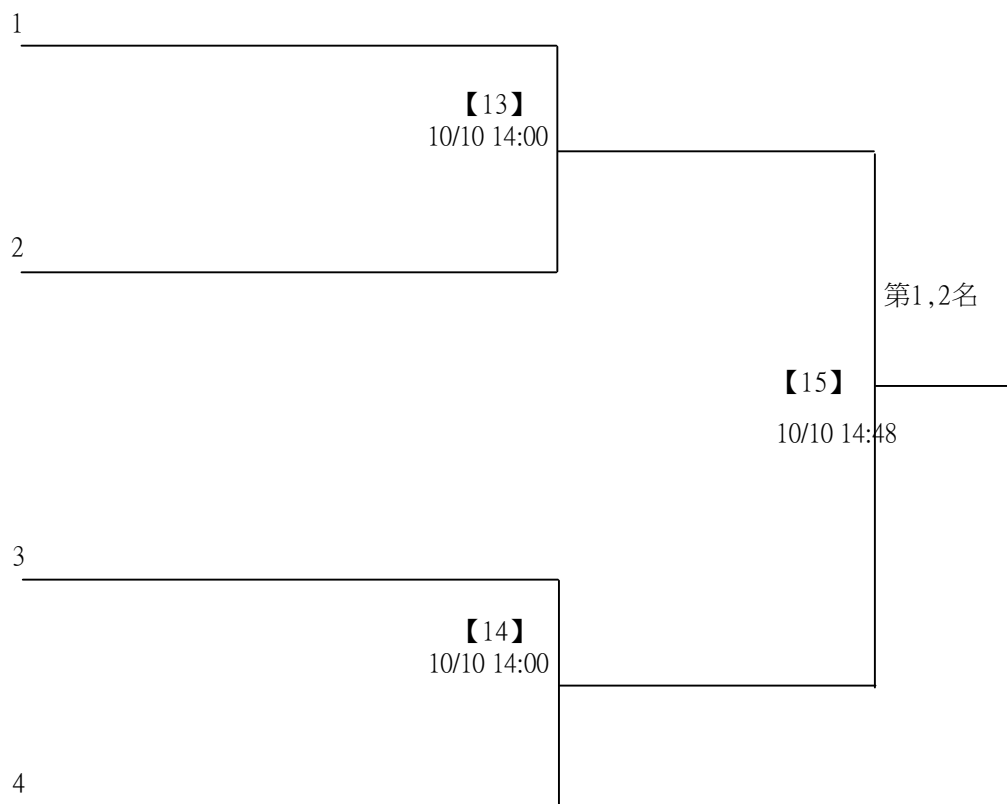

# 2023婕斯羽你同行國小暨親子分齡賽

取4名

國小高年級組母子雙打 共12籤

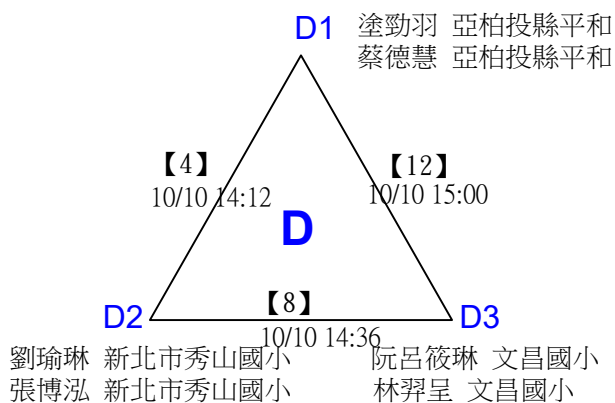
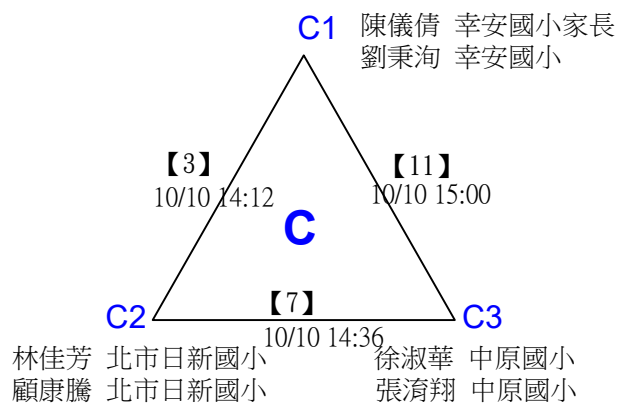
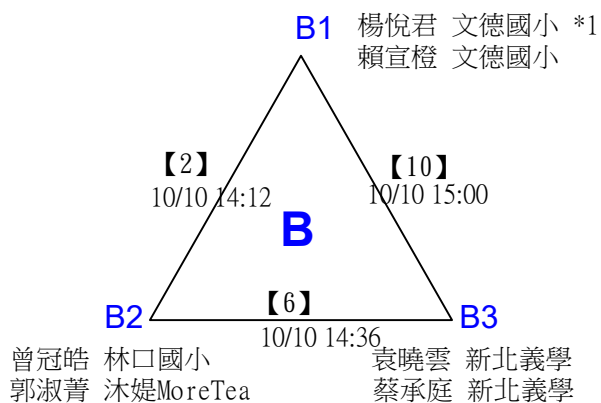
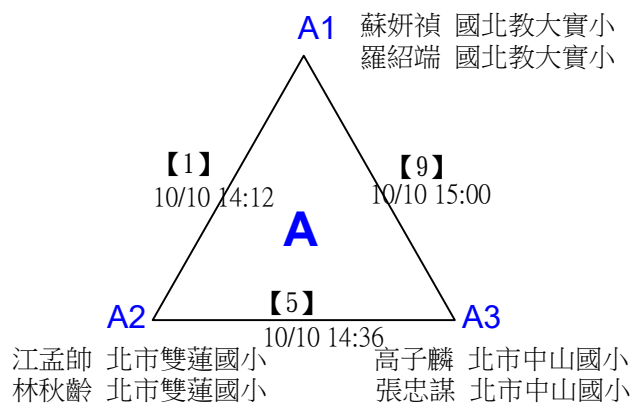



# 2023婕斯羽你同行國小暨親子分齡賽

國小高年級組母子雙打

取4名

決賽：三角取一，抽籤決定位置。

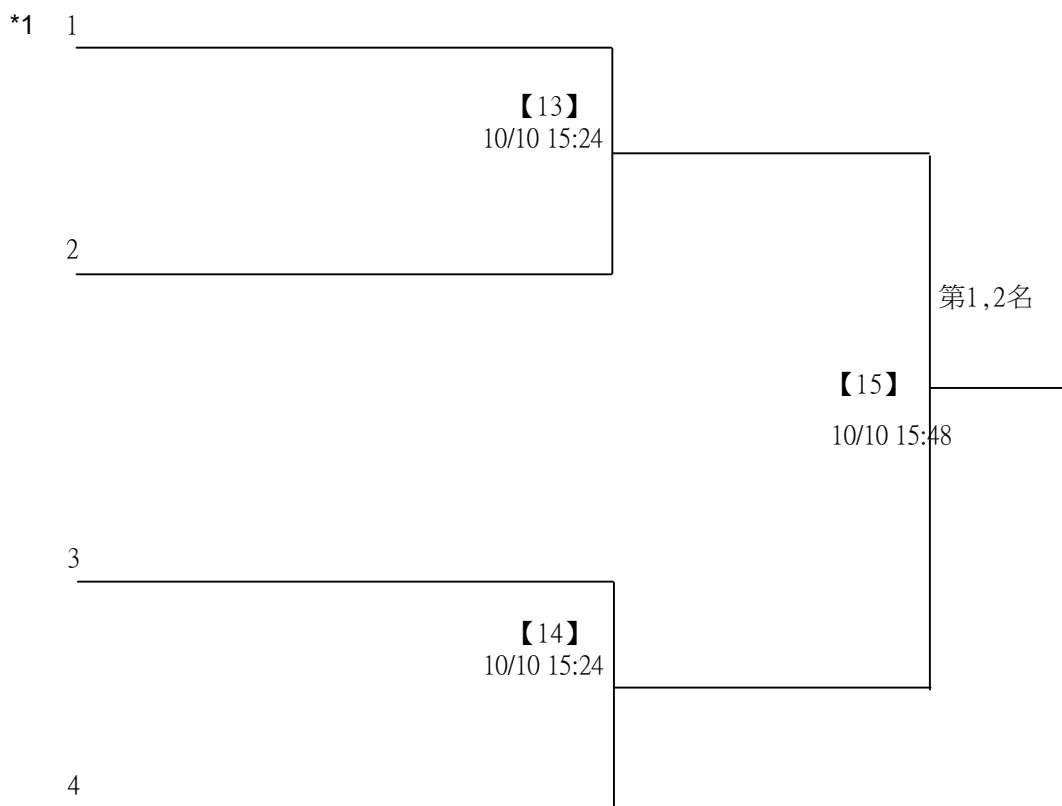

# 2023婕斯羽你同行國小暨親子分齡賽

取4名

國小高年級組父女雙打 共18籤

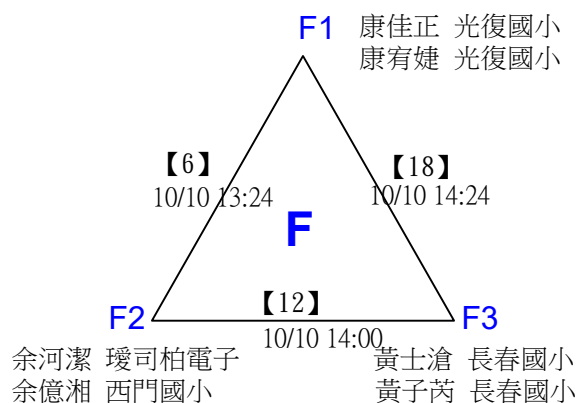
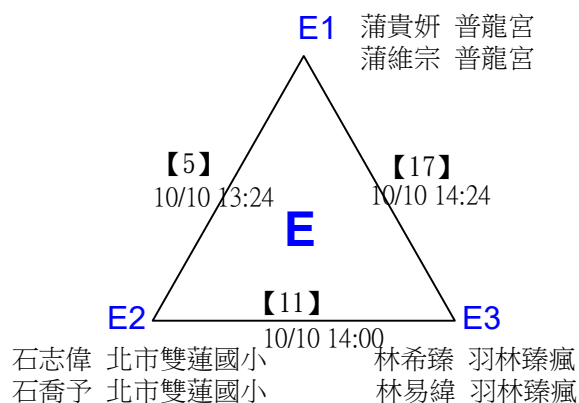
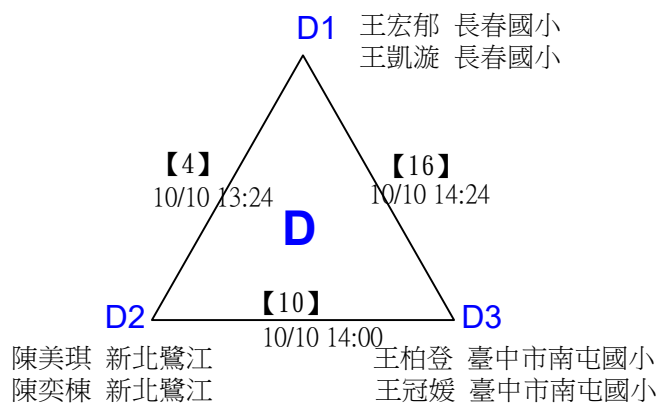
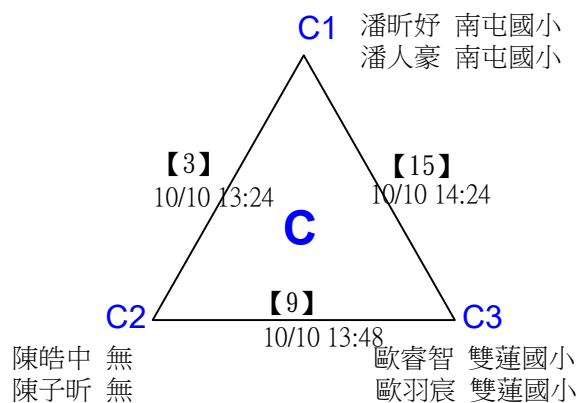
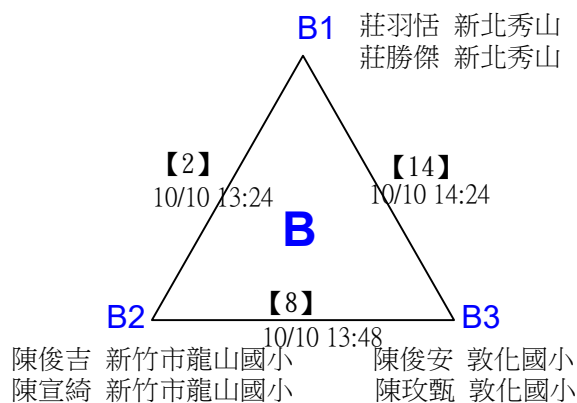
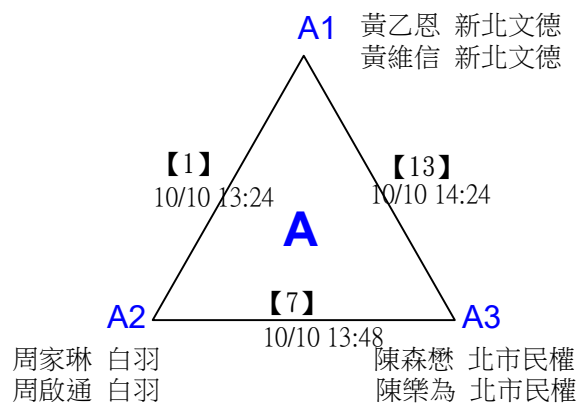

# 2023 婕斯羽你同行 國小暨親子分齡賽

取4名

國小高年級組父女雙打

決賽：三角取一，抽籤決定位置。

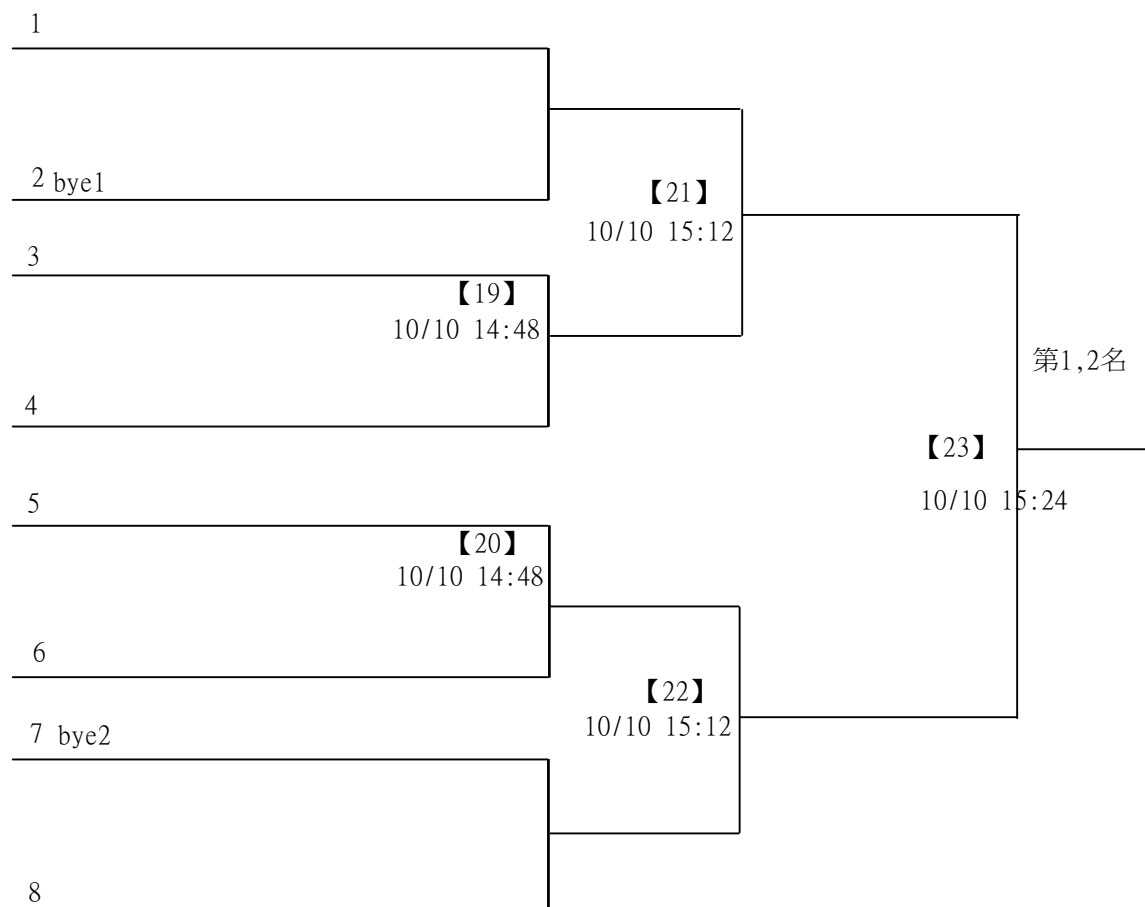

# 2023捷斯羽你同行國小暨親子分齡賽

取4名

國小高年級組父子雙打 共46籤

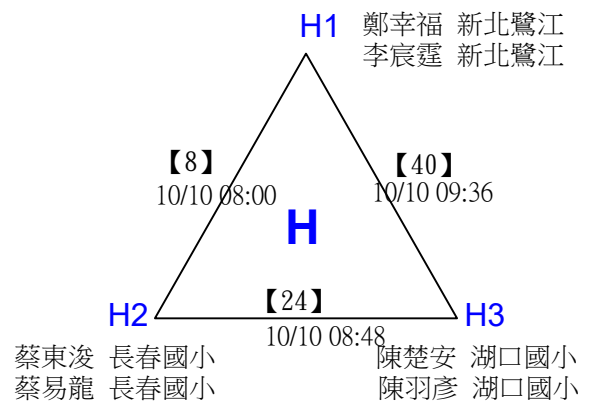
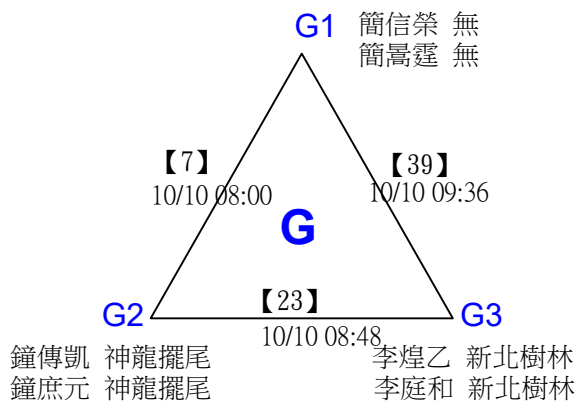
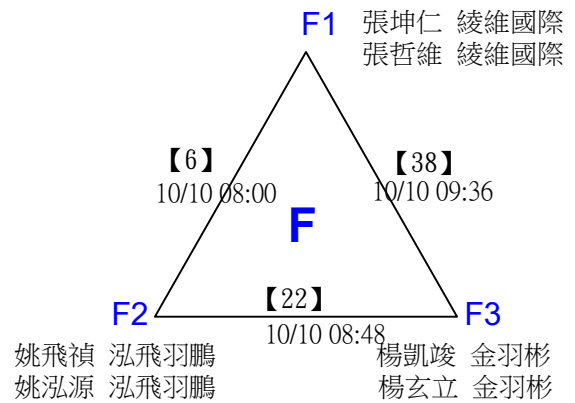
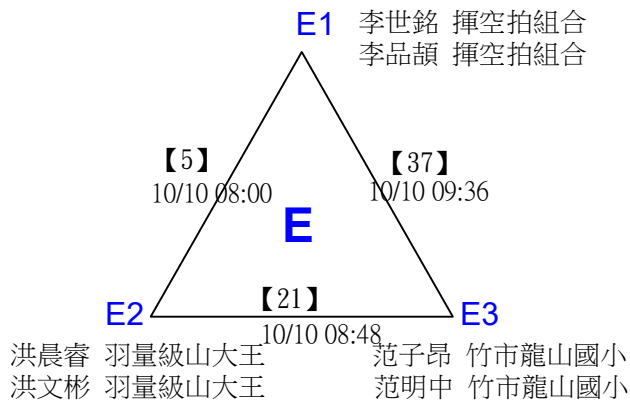
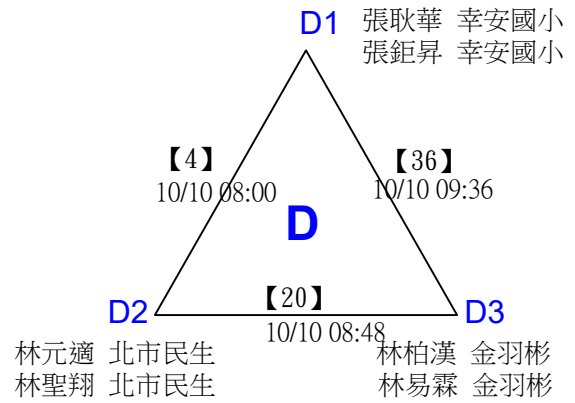
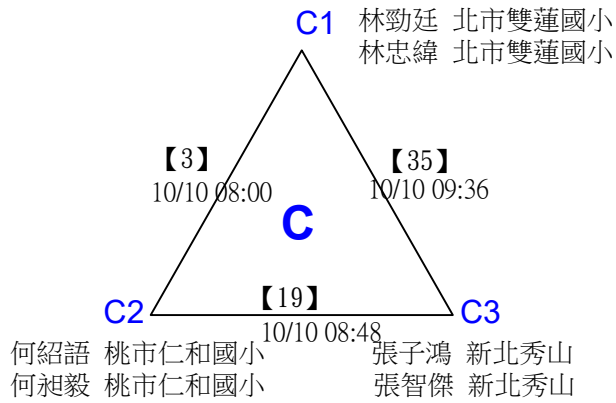
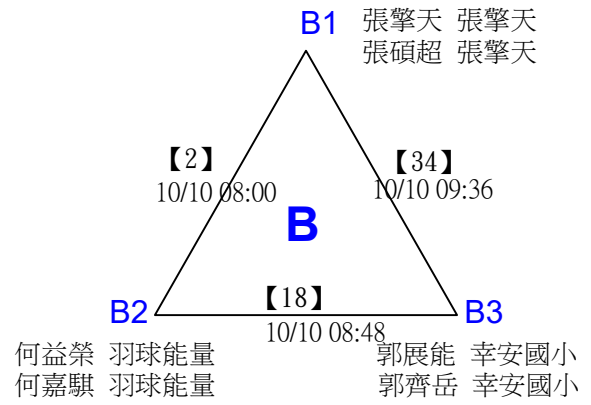
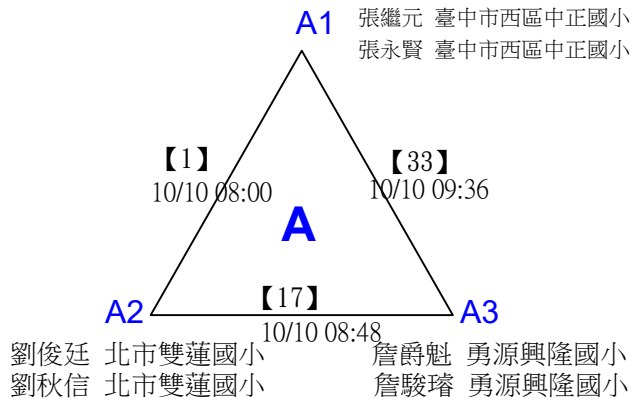

# 2023 婕斯羽你同行 國小暨親子分齡賽

取4名

國小高年級組父子雙打 共46籤

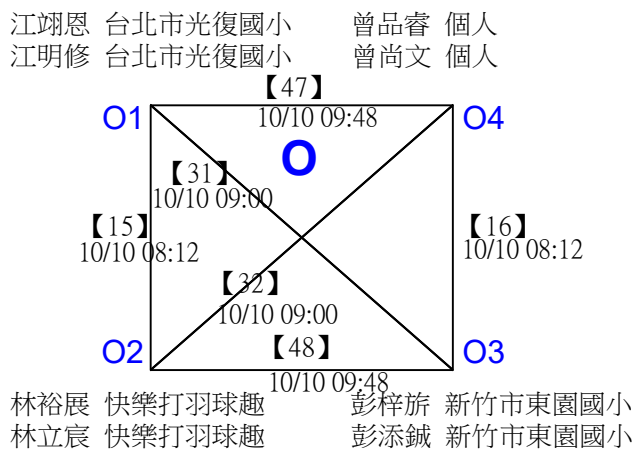
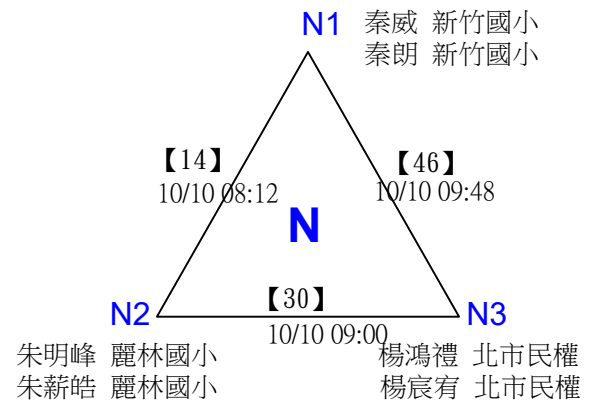
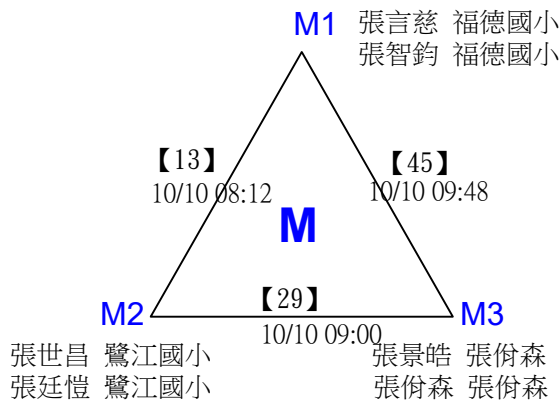
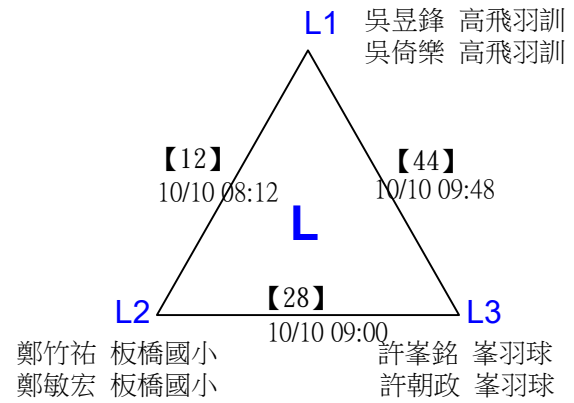
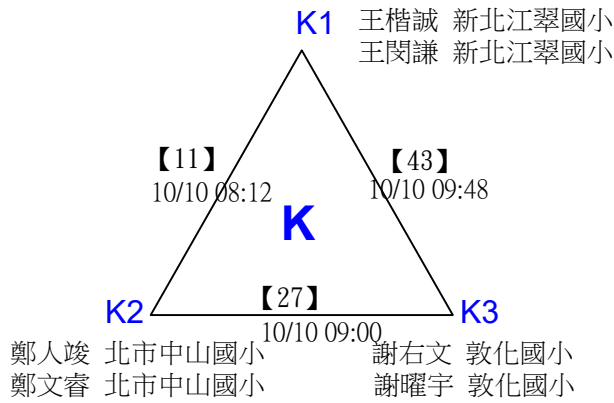
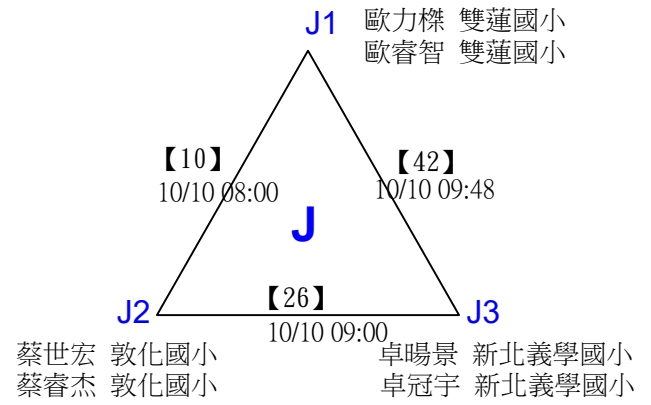
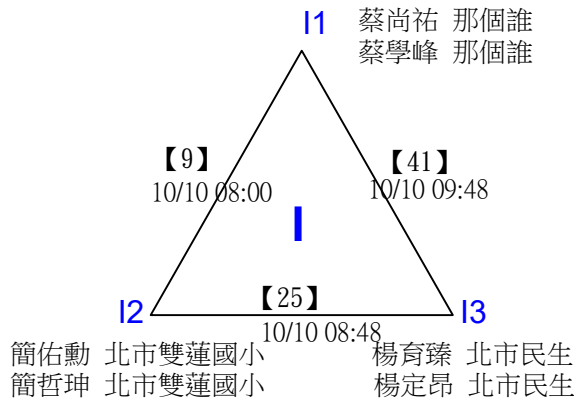

# 2023 婕斯羽你同行 國小暨親子分齡賽

取4名

國小高年級組父子雙打

決賽：三角取一，四角取二，抽籤決定位置。

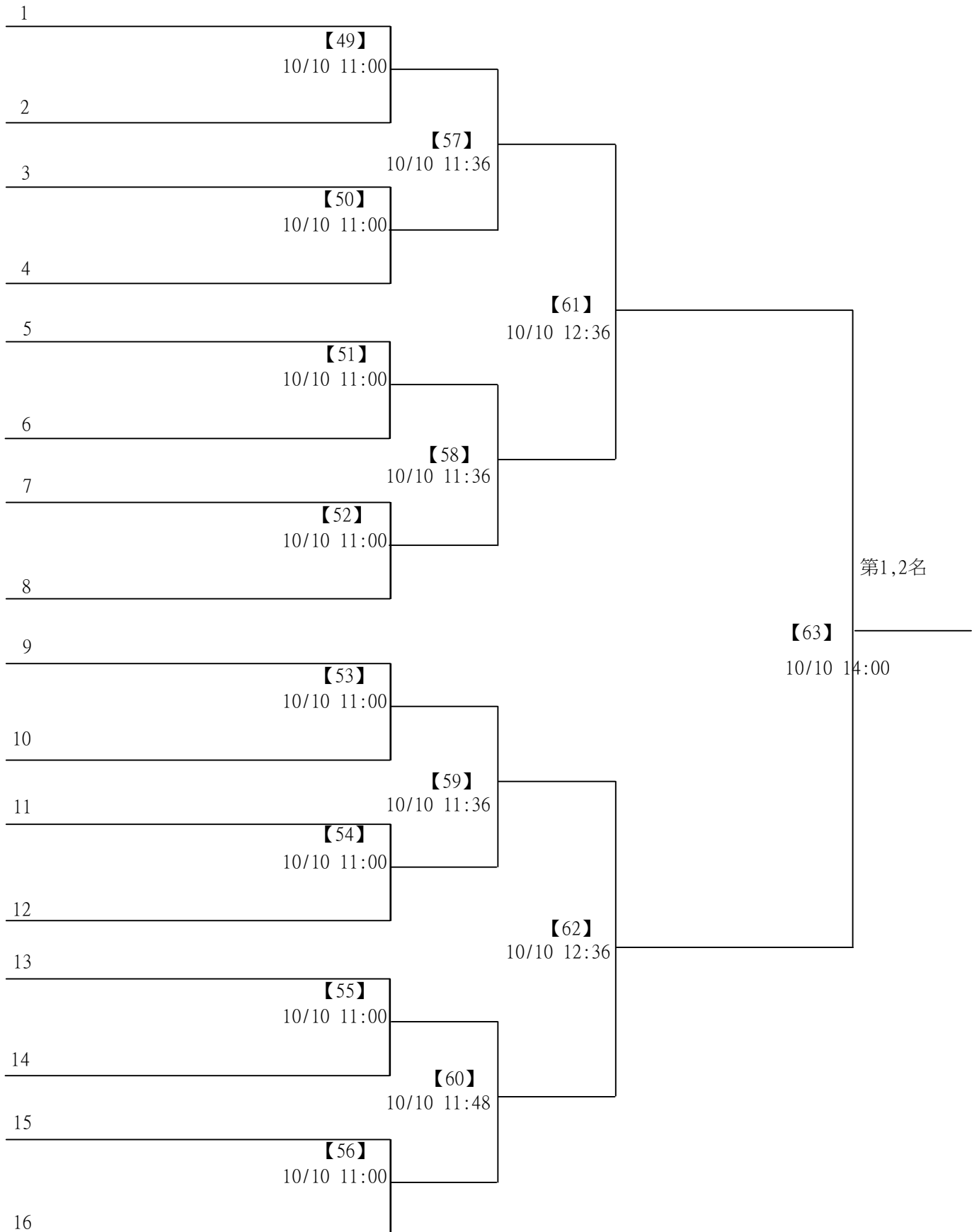

# 2023 婕斯羽你同行 國小暨親子分齡賽

取4名

台北婕斯家族VIP菁英賽

共12籤

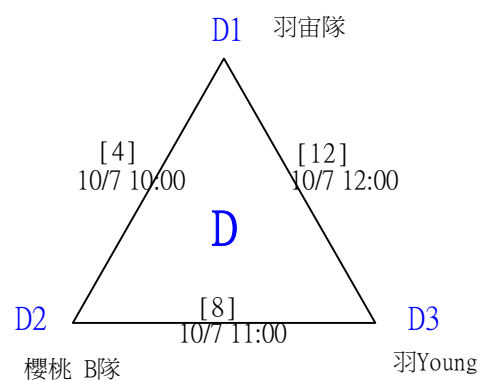
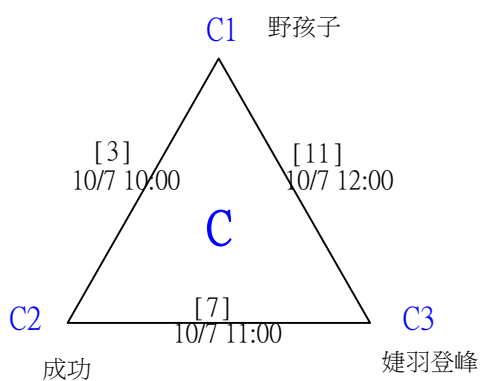
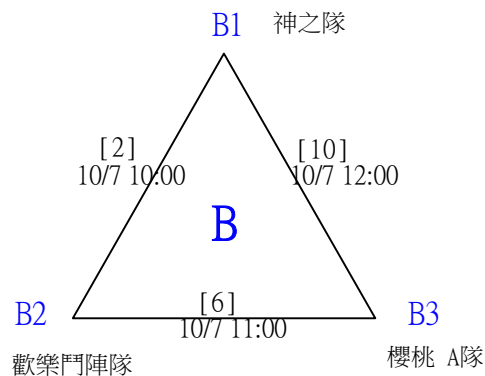
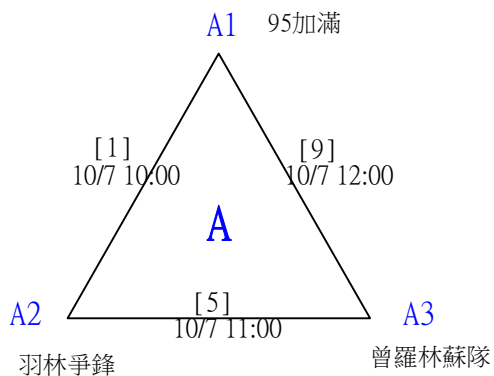

# 2023婕斯羽你同行國小暨親子分齡賽

取4名

台北婕斯家族VIP菁英賽

決賽：三角取一，抽籤決定位置。

